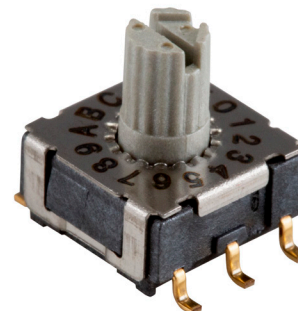
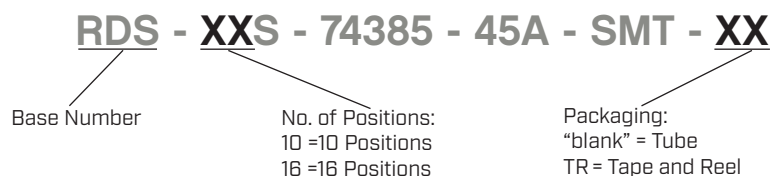

**SERIES:** RDS-74385-45A-SMT | **DESCRIPTION:** ROTARY DIP SWITCH**FEATURES**

- 10 and 16 positions
- raised actuator
- surface mount
- tube or tape and reel packaging

**SPECIFICATIONS**

parameter	conditions/description	min	typ	max	units
rated voltage	switching			42	Vdc
	non-switching			42	Vdc
rated current	switching			100	mA
	non-switching			400	mA
withstanding voltage	for 1 minute		250		Vac
contact resistance				80	mΩ
insulation resistance	at 250 Vdc	100			MΩ
operating torque		90	120	150	gf*cm
actuator travel	continuous rotation		360		degrees
operating temperature		-60		125	°C
storage temperature		-60		125	°C
life	at rated voltage, current, 15-20 cycles/minute		25,000		steps
flammability rating	UL94V-0				
RoHS	yes				
IP level	IP67 (IEC 60529:2001)				

**PART NUMBER KEY**

## MECHANICAL DRAWING

units: mm  
 tolerance: ±0.3 mm  
 unless otherwise noted

ITEM	DESCRIPTION	MATERIAL	PLATING/COLOR
1	actuator	LCP (UL94V-0)	red (10 position) gray (16 position)
2	housing	LCP (UL94V-0)	black
3	face plate	stainless steel	
4	terminals	copper alloy	gold

### 10 POSITION

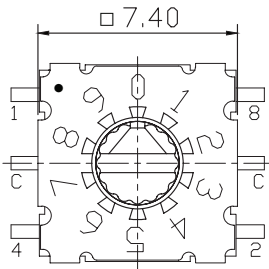

### 16 POSITION

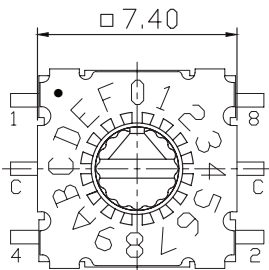

		ON ○				
		OFF ●	CODE			
TYPE		POS	1	2	4	8
10 STEP	0	●	●	●	●	●
	1	○	●	●	●	●
	2	●	○	●	●	●
	3	○	○	●	●	●
	4	●	●	○	●	●
	5	○	●	○	●	●
	6	●	○	○	●	●
	7	○	○	○	○	●
	8	●	●	●	●	○
	9	○	●	●	●	○
16 STEP	A	●	○	●	○	○
	B	○	○	●	○	○
	C	●	●	○	○	○
	D	○	●	○	○	○
	E	●	○	○	○	○
	F	○	○	○	○	○

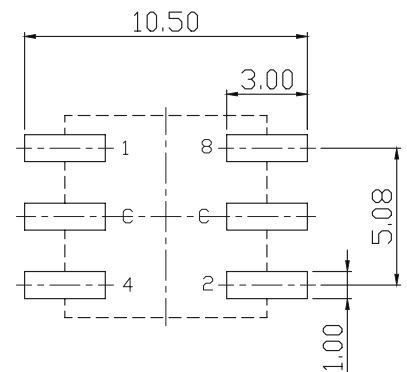
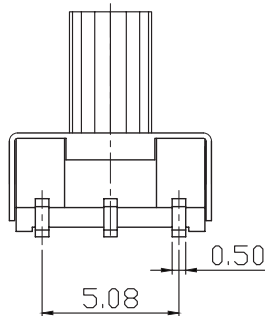
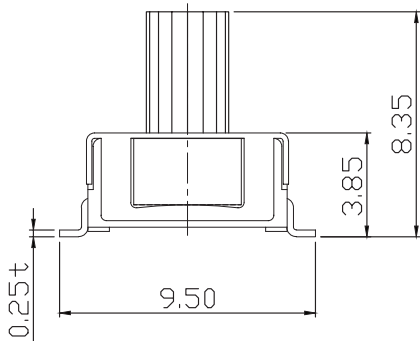

Recommended PCB Layout  
Top View

## SOLDERABILITY

parameter	conditions/description	min	typ	max	units
hand soldering	for maximum 3 seconds			350	°C
reflow soldering		255		260	°C

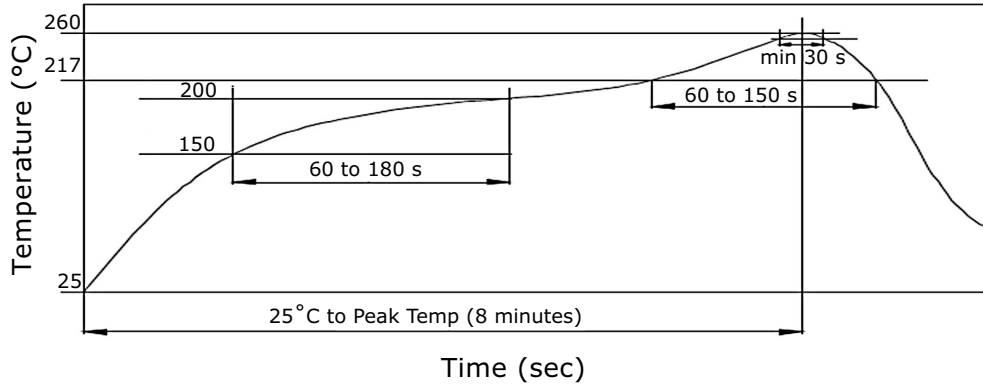

## PACKAGING (TUBE)

units: mm

Tube Size: 13.0 x 14.50 x 540 mm

Tube QTY: 70 pcs

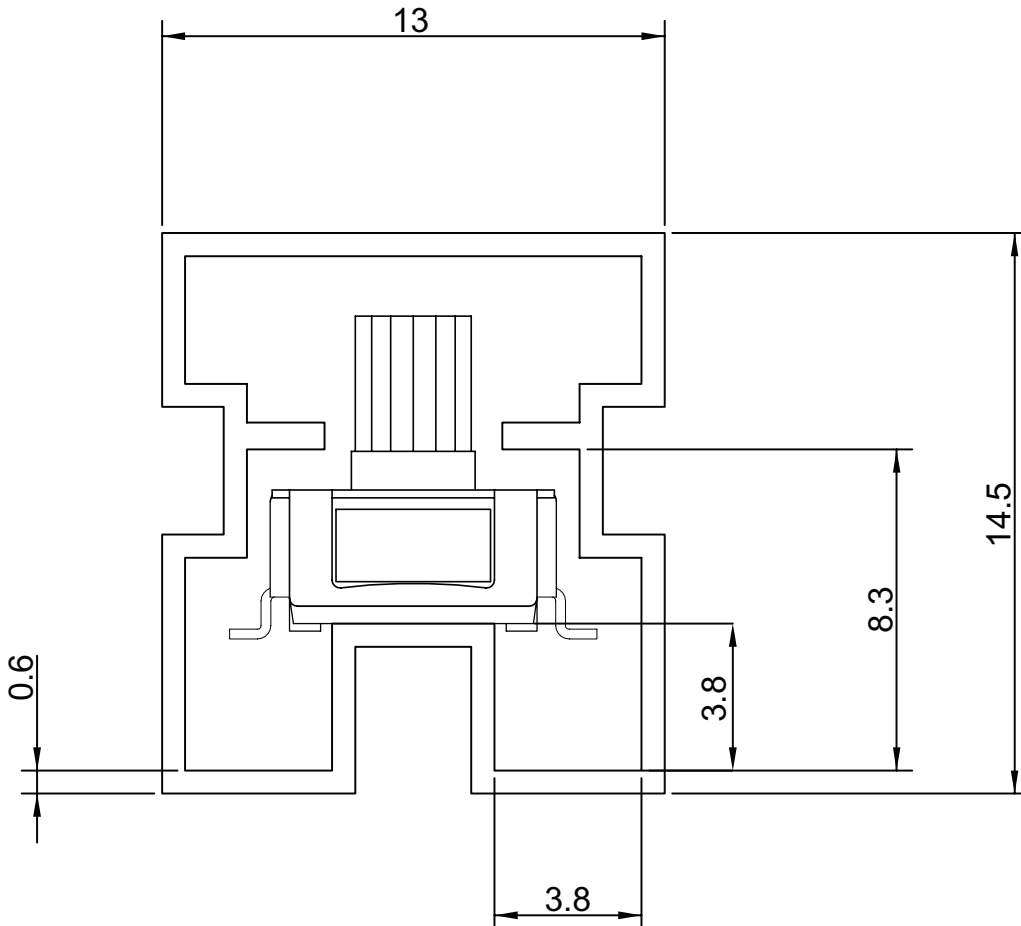

## PACKAGING (TAPE & REEL )

units: mm

Reel Size:  $\varnothing$ 330 mm

QTY: 600 pcs

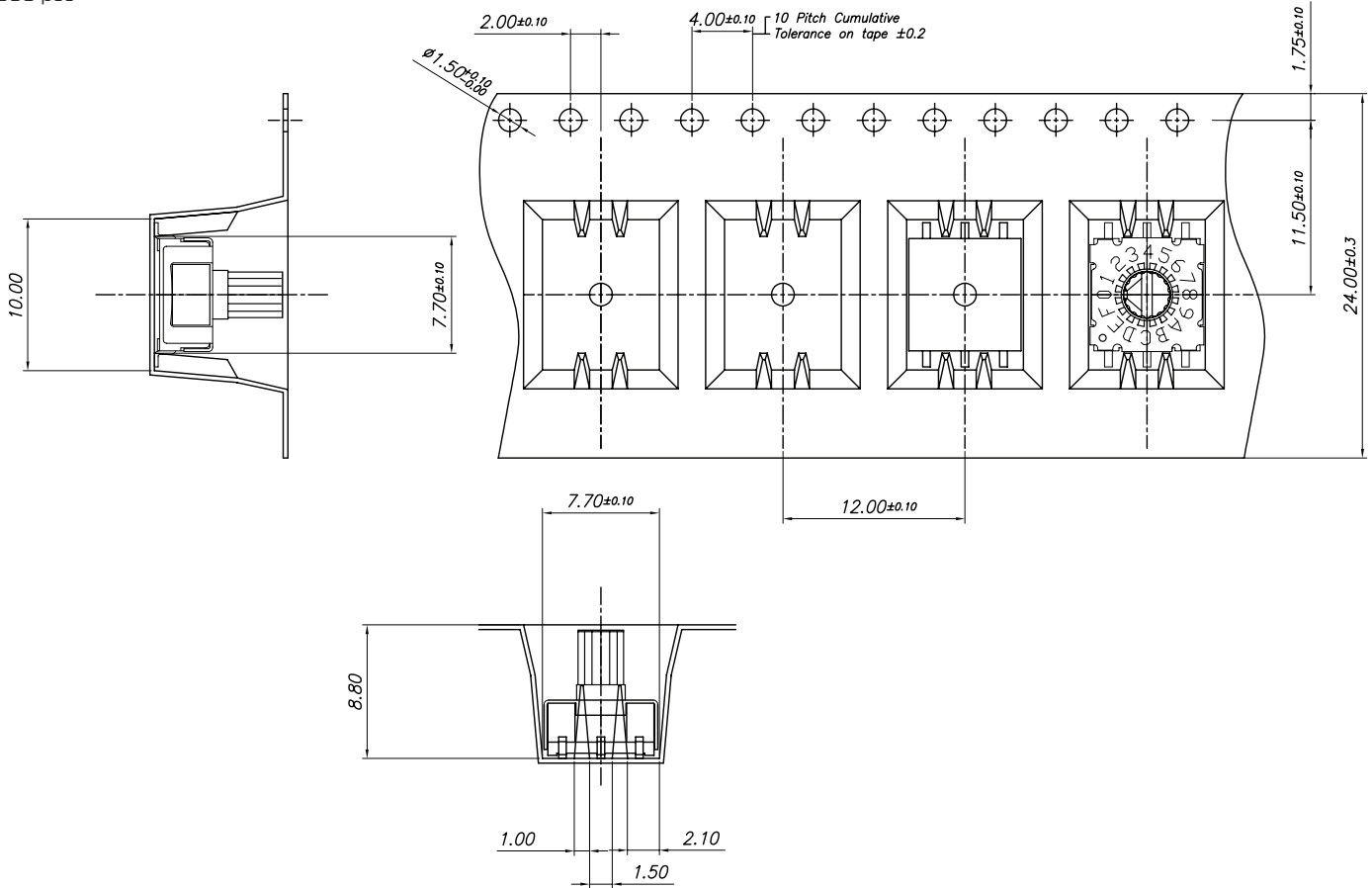

## REVISION HISTORY

rev.	description	date
1.0	initial release	10/06/2020
1.01	logo, datasheet style update	08/05/2022

The revision history provided is for informational purposes only and is believed to be accurate.



CUI Devices offers a one (1) year limited warranty. Complete warranty information is listed on our website.

CUI Devices reserves the right to make changes to the product at any time without notice. Information provided by CUI Devices is believed to be accurate and reliable. However, no responsibility is assumed by CUI Devices for its use, nor for any infringements of patents or other rights of third parties which may result from its use.

CUI Devices products are not authorized or warranted for use as critical components in equipment that requires an extremely high level of reliability. A critical component is any component of a life support device or system whose failure to perform can be reasonably expected to cause the failure of the life support device or system, or to affect its safety or effectiveness.

[cuidevices.com](http://cuidevices.com)