

Plastic Silicon Infrared Phototransistor

QSE122

Description

The QSE122 is a silicon phototransistor encapsulated in a wide angle, infrared transparent, black plastic sidelooker package.

Features

- NPN Silicon Phototransistor
- Package Type: Sidelooker
- Medium Wide Reception Angle, 50°
- Package Material and Color: Black Epoxy
- Matched Emitter: QEE113
- Daylight Filter
- High Sensitivity
- Red Dot Marking on the Top Side
- This is a Pb-Free Device

ABSOLUTE MAXIMUM RATINGS (T_A = 25°C unless otherwise noted)

| Symbol | Parameter | Value | Unit |
|--------------------|--|--------------|------|
| T _{OPR} | Operating Temperature | -40 to +100 | °C |
| T _{STG} | Storage Temperature | -40 to +100 | °C |
| T _{SOL-I} | Soldering Temperature (Iron) (Note 2), (Note 3), (Note 4) | 240 for 5 s | °C |
| T _{SOL-F} | Soldering Temperature (Flow) (Note 2), (Note 3) | 260 for 10 s | °C |
| V _{CE} | Collector Emitter Voltage | 30 | V |
| V _{EC} | Emitter Collector Voltage | 5 | V |
| P _D | Power Dissipation (Note 1) | 100 | mW |

Stresses exceeding those listed in the Maximum Ratings table may damage the device. If any of these limits are exceeded, device functionality should not be assumed, damage may occur and reliability may be affected.

1. Derate power dissipation linearly 1.33 mW/°C above 25°C.
2. RMA flux is recommended.
3. Methanol or isopropyl alcohols are recommended as cleaning agents.
4. Soldering iron 1/16" (1.6 mm) minimum from housing.

SCHEMATIC

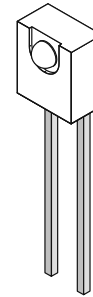
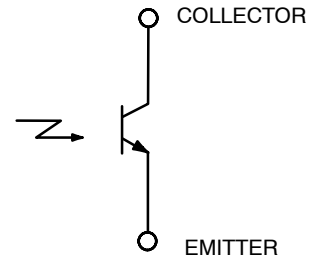

SIDELOOKER DETECTOR
CASE 100CN

ORDERING INFORMATION

| Device | Package | Shipping |
|--------|-------------------------------------|-------------------|
| QSE122 | SIDELOOKER DETECTOR (Pb-Free) | 500 / Bulk Bag |

QSE122

ELECTRICAL CHARACTERISTICS ($T_A = 25^\circ\text{C}$)

| Symbol | Parameter | Test Conditions | Min | Typ | Max | Unit |
|----------------|-------------------------------------|--|-----|----------|------|---------------|
| λ_{PS} | Peak Sensitivity | | – | 880 | – | nm |
| Θ | Reception Angle | | – | ± 25 | – | $^\circ$ |
| I_{CEO} | Collector Emitter Dark Current | $V_{CE} = 10\text{ V}, E_e = 0$ | – | – | 100 | nA |
| BV_{CEO} | Collector–Emitter Breakdown | $I_C = 1\text{ mA}$ | 30 | – | – | V |
| BV_{ECO} | Emitter–Collector Breakdown | $I_E = 100\ \mu\text{A}$ | 5 | – | – | V |
| $I_{C(ON)}$ | On–State Collector Current (Note 5) | $E_e = 0.5\text{ mW/cm}^2, V_{CE} = 5\text{ V}$ | 3.0 | – | 12.0 | mA |
| $V_{CE(SAT)}$ | Saturation Voltage (Note 5) | $E_e = 0.5\text{ mW/cm}^2, I_C = 0.1\text{ mA}$ | – | – | 0.4 | V |
| t_r | Rise Time | $I_C = 1\text{ mA}, V_{CC} = 5\text{ V},$ $R_L = 100\ \Omega$ | – | 8 | – | μs |
| t_f | Fall Time | | – | 8 | – | μs |

Product parametric performance is indicated in the Electrical Characteristics for the listed test conditions, unless otherwise noted. Product performance may not be indicated by the Electrical Characteristics if operated under different conditions.

5. $\lambda = 880\text{ nm}$ (AlGaAs).

TYPICAL PERFORMANCE CHARACTERISTICS

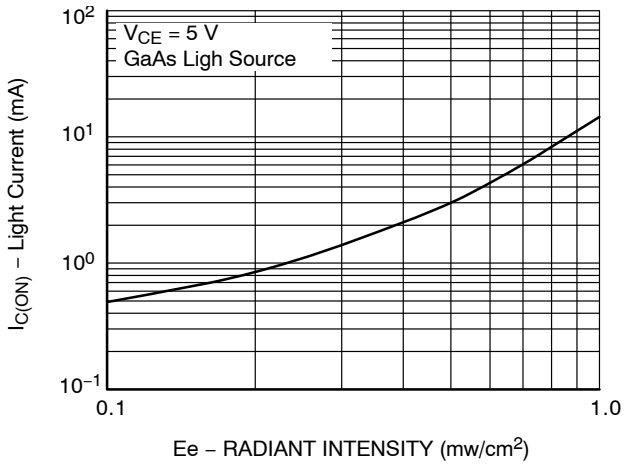

Figure 1. Light Current vs. Radiant Intensity

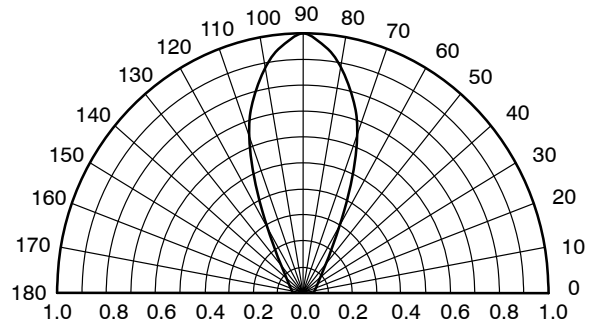

Figure 2. Angular Response Curve

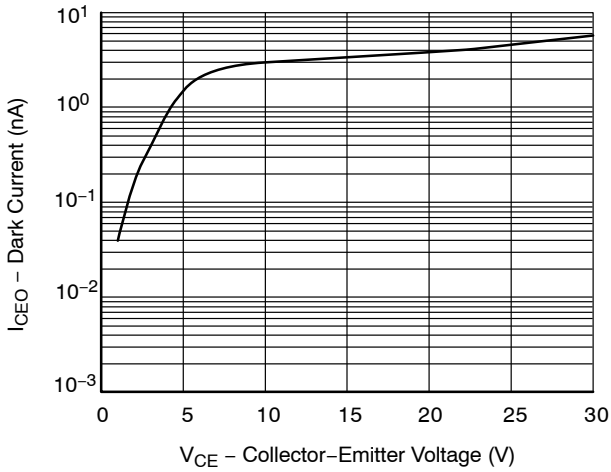

Figure 3. Dark Current vs. Collector - Emitter Voltage

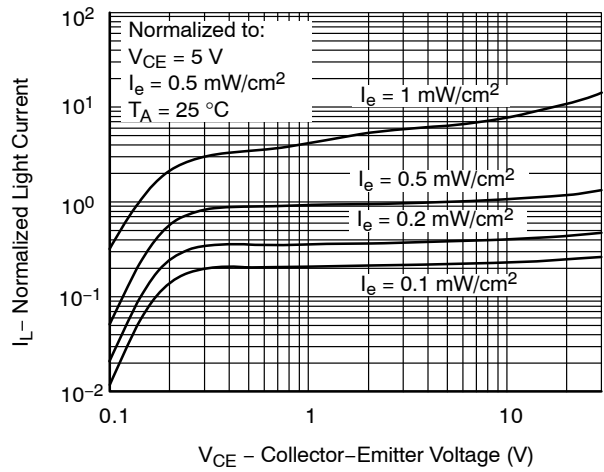

Figure 4. Light Current vs. Collector - Emitter Voltage

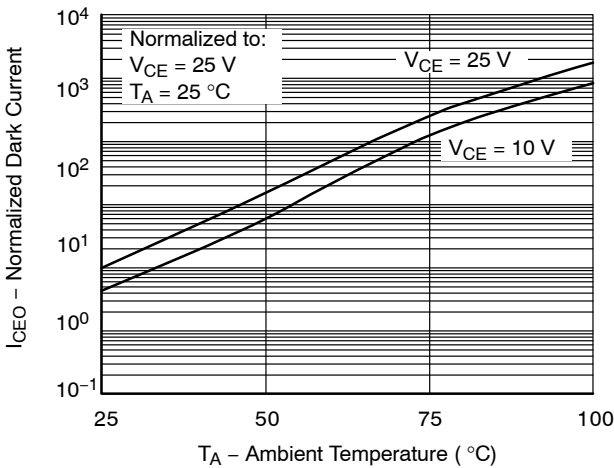
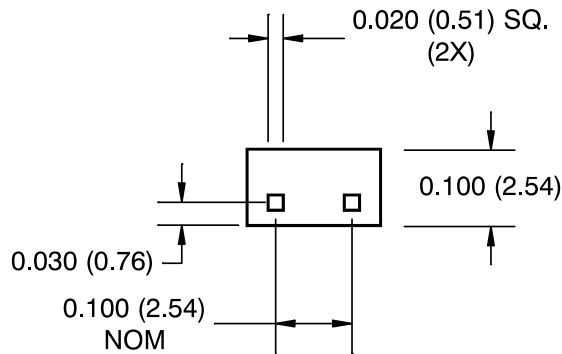
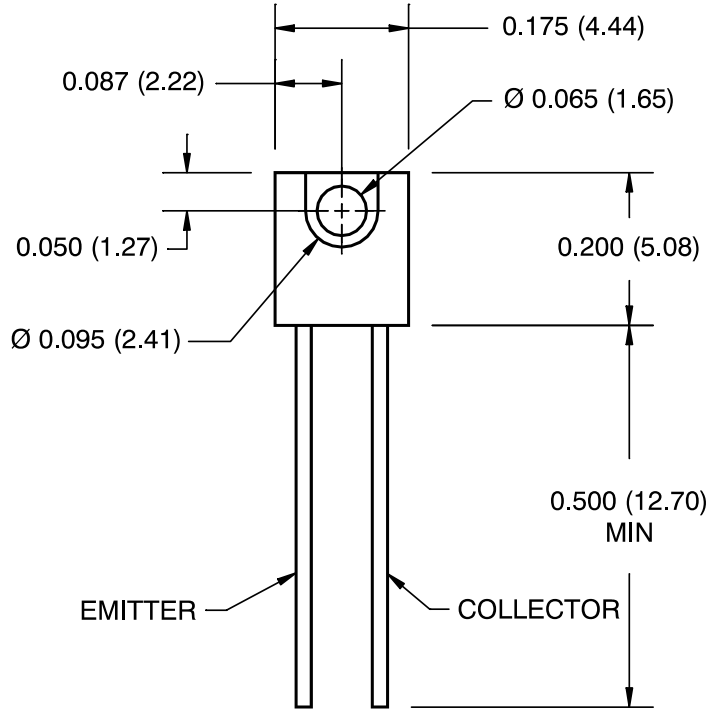

Figure 5. Dark Current vs. Ambient Temperature

SIDELOOKER DETECTOR
CASE 100CN
ISSUE O

DATE 30 NOV 2016



Notes:

1. Dimensions for all drawings are in inches (mm).
2. Tolerance of ± 0.010 (0.25) on all non-nominal dimensions unless otherwise specified.

| | | |
|-------------------------|----------------------------|---|
| DOCUMENT NUMBER: | 98AON13424G | Electronic versions are uncontrolled except when accessed directly from the Document Repository. Printed versions are uncontrolled except when stamped "CONTROLLED COPY" in red. |
| DESCRIPTION: | SIDELOOKER DETECTOR | PAGE 1 OF 1 |

ON Semiconductor and  are trademarks of Semiconductor Components Industries, LLC dba ON Semiconductor or its subsidiaries in the United States and/or other countries. ON Semiconductor reserves the right to make changes without further notice to any products herein. ON Semiconductor makes no warranty, representation or guarantee regarding the suitability of its products for any particular purpose, nor does ON Semiconductor assume any liability arising out of the application or use of any product or circuit, and specifically disclaims any and all liability, including without limitation special, consequential or incidental damages. ON Semiconductor does not convey any license under its patent rights nor the rights of others.

onsemi, **Onsemi**, and other names, marks, and brands are registered and/or common law trademarks of Semiconductor Components Industries, LLC dba "**onsemi**" or its affiliates and/or subsidiaries in the United States and/or other countries. **onsemi** owns the rights to a number of patents, trademarks, copyrights, trade secrets, and other intellectual property. A listing of **onsemi**'s product/patent coverage may be accessed at www.onsemi.com/site/pdf/Patent-Marking.pdf. **onsemi** reserves the right to make changes at any time to any products or information herein, without notice. The information herein is provided "as-is" and **onsemi** makes no warranty, representation or guarantee regarding the accuracy of the information, product features, availability, functionality, or suitability of its products for any particular purpose, nor does **onsemi** assume any liability arising out of the application or use of any product or circuit, and specifically disclaims any and all liability, including without limitation special, consequential or incidental damages. Buyer is responsible for its products and applications using **onsemi** products, including compliance with all laws, regulations and safety requirements or standards, regardless of any support or applications information provided by **onsemi**. "Typical" parameters which may be provided in **onsemi** data sheets and/or specifications can and do vary in different applications and actual performance may vary over time. All operating parameters, including "Typicals" must be validated for each customer application by customer's technical experts. **onsemi** does not convey any license under any of its intellectual property rights nor the rights of others. **onsemi** products are not designed, intended, or authorized for use as a critical component in life support systems or any FDA Class 3 medical devices or medical devices with a same or similar classification in a foreign jurisdiction or any devices intended for implantation in the human body. Should Buyer purchase or use **onsemi** products for any such unintended or unauthorized application, Buyer shall indemnify and hold **onsemi** and its officers, employees, subsidiaries, affiliates, and distributors harmless against all claims, costs, damages, and expenses, and reasonable attorney fees arising out of, directly or indirectly, any claim of personal injury or death associated with such unintended or unauthorized use, even if such claim alleges that **onsemi** was negligent regarding the design or manufacture of the part. **onsemi** is an Equal Opportunity/Affirmative Action Employer. This literature is subject to all applicable copyright laws and is not for resale in any manner.

ADDITIONAL INFORMATION

TECHNICAL PUBLICATIONS:

Technical Library: www.onsemi.com/design/resources/technical-documentation
onsemi Website: www.onsemi.com

ONLINE SUPPORT: www.onsemi.com/support

For additional information, please contact your local Sales Representative at www.onsemi.com/support/sales