

SERIES: PSK-3D | **DESCRIPTION:** INTERNAL AC-DC POWER SUPPLY

FEATURES

- wide input range (85 ~ 305 Vac)
- wide operating temperature range (-40 to +85 C)
- Class B emissions
- certified to 62368, 61558, and 60335 safety standards
- over voltage, over current, short circuit protections
- compact 1 x 1 inch encapsulated package

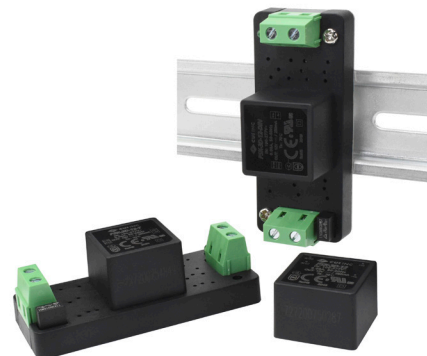

| MODEL | output voltage | output current | output power | ripple and noise ¹ | efficiency ² |
|-----------|----------------|----------------|--------------|-------------------------------|-------------------------|
| | (Vdc) | max (A) | max (W) | max (mVp-p) | typ (%) |
| PSK-3D-3 | 3.3 | 0.9 | 3 | 100 | 72 |
| PSK-3D-5 | 5 | 0.6 | 3 | 100 | 76 |
| PSK-3D-9 | 9 | 0.333 | 3 | 100 | 78 |
| PSK-3D-12 | 12 | 0.25 | 3 | 100 | 78 |
| PSK-3D-15 | 15 | 0.2 | 3 | 100 | 79 |
| PSK-3D-24 | 24 | 0.125 | 3 | 100 | 79 |

Notes: 1. Ripple & noise are measured at 20 MHz BW with 10 μ F aluminum electrolytic capacitor and 1 μ F ceramic capacitor on the output. See application circuit.
 2. Measured at 230 Vac.
 3. All specifications are measured at Ta=25°C, humidity <75%, nominal input voltage, and rated output load unless otherwise specified.

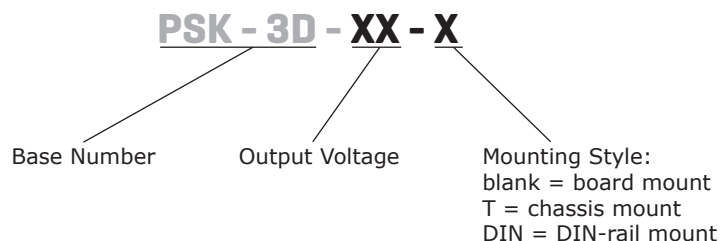
PART NUMBER KEY

INPUT

| parameter | conditions/description | min | typ | max | units |
|-----------------|------------------------|-----|-----|------|-------|
| voltage | ac input | 85 | | 305 | Vac |
| | dc input | 100 | | 430 | Vdc |
| frequency | | 47 | | 63 | Hz |
| current | at 115 Vac | | | 0.08 | A |
| | at 230 Vac | | | 0.06 | A |
| inrush current | at 115 Vac | | 15 | | A |
| | at 230 Vac | | 25 | | A |
| leakage current | 277 Vac/50 Hz | | | 0.25 | mA |

OUTPUT

| parameter | conditions/description | min | typ | max | units |
|---------------------------|---------------------------------------------------------|-----|------|-------|-------|
| capacitive load | 3.3 Vdc output model | | | 4,000 | μF |
| | 5 Vdc output model | | | 3,000 | μF |
| | 9 Vdc output model | | | 1,200 | μF |
| | 12 Vdc output model | | | 1,200 | μF |
| | 15 Vdc output model | | | 680 | μF |
| | 24 Vdc output model | | | 220 | μF |
| output voltage accuracy | 3.3 Vdc output model | | ±3 | | % |
| | all other output models | | ±2 | | % |
| line regulation | at full load | | ±0.5 | | % |
| load regulation | 0~100% load | | ±1.0 | | % |
| hold-up time | at 115 Vac | | 5 | | ms |
| | at 230 Vac | | 50 | | ms |
| switching frequency | | | 65 | | kHz |
| no load power consumption | at 230 Vac | | 0.2 | | W |
| | 5 Vdc & 12 Vdc output models all other output models | | 0.1 | | W |

PROTECTIONS

| parameter | conditions/description | min | typ | max | units |
|--------------------------|-----------------------------------|-----|-----|-----|-------|
| over voltage protection | 3.3 & 5 Vdc output models | | | 7.5 | V |
| | 9 Vdc output model | | | 15 | V |
| | 12 Vdc output model | | | 16 | V |
| | 15 Vdc output model | | | 20 | V |
| | 24 Vdc output model | | | 30 | V |
| over current protection | auto recovery | | | 200 | % |
| short circuit protection | continuous, auto recovery, hiccup | | | | |

SAFETY & COMPLIANCE

| parameter | conditions/description | min | typ | max | units |
|-------------------|---------------------------------------------------------------------------------------|-------|-----|-----|-------|
| isolation voltage | input to output, 1 min. <5mA | 4,000 | | | Vac |
| safety approvals | certified to 62368: IEC, EN, UL/cUL | | | | |
| | certified to 61558: EN | | | | |
| | certified to 60335: EN | | | | |
| safety class | Class II | | | | |
| EMI/EMC | CISPR32/EN55032 CLASS B EN55014-1 | | | | |
| ESD | IEC/EN 61000-4-2 Contact ±6KV/Air ±8KV perf. Criteria B EN55014-2 perf. Criteria B | | | | |
| radiated immunity | IEC/EN61000-4-3 10V/m perf. Criteria A EN55014-2 perf. Criteria A | | | | |

SAFETY & COMPLIANCE

| | | | |
|-------------------------------|------------------------------------------------------------------------------------------------------------------------------------------------------------------------------------------------------------------------|-----------|-------|
| EFT/burst | IEC/EN61000-4-4 ±2KV (See Fig.1 for typical application circuit) perf. Criteria B IEC/EN61000-4-4 ±4KV (See Fig.2 for recommended circuit) perf. Criteria B EN55014-2 perf. Criteria B | | |
| surge | IEC/EN61000-4-5 line to line ±1KV (See Fig.1 for typical application circuit) perf. Criteria B IEC/EN61000-4-5 line to line ±2KV (See Fig.2 for recommended circuit) perf. Criteria B EN55014-2 perf. Criteria B | | |
| conducted immunity | IEC/EN61000-4-6 10Vr.m.s perf. Criteria A EN55014-2 perf. Criteria A | | |
| voltage dips and interruption | IEC/EN61000-4-11 0%, 70% perf. Criteria B EN55014-2 perf. Criteria B | | |
| MTBF | MIL-HDBK-217F at 25°C | 2,799,000 | hours |
| RoHS | yes | | |

ENVIRONMENTAL

| parameter | conditions/description | min | typ | max | units |
|-----------------------|------------------------|-----|-----|-----|-------|
| operating temperature | | -40 | | 85 | °C |
| storage temperature | | -40 | | 105 | °C |
| storage humidity | | 0 | | 95 | % |

SOLDERABILITY

| parameter | conditions/description | min | typ | max | units |
|----------------|------------------------|-----|-----|-----|-------|
| wave soldering | 5~10 seconds max | 255 | 260 | 265 | °C |
| hand soldering | 3~5 seconds max | 350 | 360 | 370 | °C |

MECHANICAL

| parameter | conditions/description | min | typ | max | units |
|---------------|-------------------------------------------------------------|-----|------|-----|-------|
| dimensions | horizontal package: 25.40 x 25.40 x 17.60 | | | | mm |
| | chassis mount: 76.00 x 31.50 x 26.40 | | | | mm |
| | DIN-rail: 76.00 x 31.50 x 31.00 | | | | mm |
| weight | horizontal package, 3.3 Vdc, 5 Vdc, 9 Vdc & 12 Vdc output | | 18.0 | | g |
| | horizontal package, 15 Vdc & 24 Vdc output | | 18.5 | | g |
| | chassis mount | | 38.0 | | g |
| | DIN-rail | | 58.0 | | g |
| case material | Black plastic, flame-retardant and heat-resistant (UL94V-0) | | | | |

MECHANICAL DRAWING

units: mm [inch]
 pin diameter tolerance: ± 0.10 [± 0.004]
 tolerance: ± 0.50 [± 0.020]

| PIN CONNECTIONS | |
|-----------------|----------|
| PIN | Function |
| 1 | AC(N) |
| 2 | AC(L) |
| 3 | no pin |
| 4 | -Vo |
| 5 | +Vo |

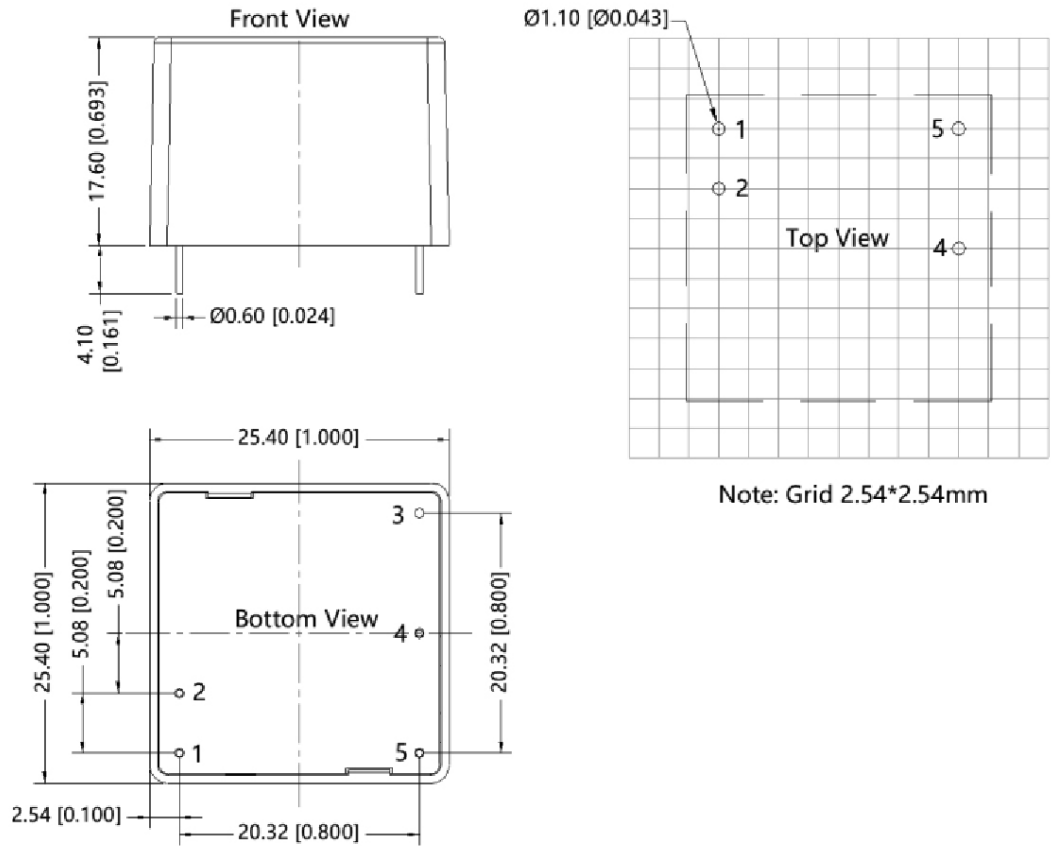

MECHANICAL DRAWING

units: mm [inch]
 wire range: 24~12 AWG
 tightening torque: Max 0.4 N·m
 tolerance: ±1.0 [±0.039]

| PIN CONNECTIONS | |
|-----------------|----------|
| PIN | Function |
| 1 | AC(N) |
| 2 | AC(L) |
| 3 | -Vo |
| 4 | +Vo |

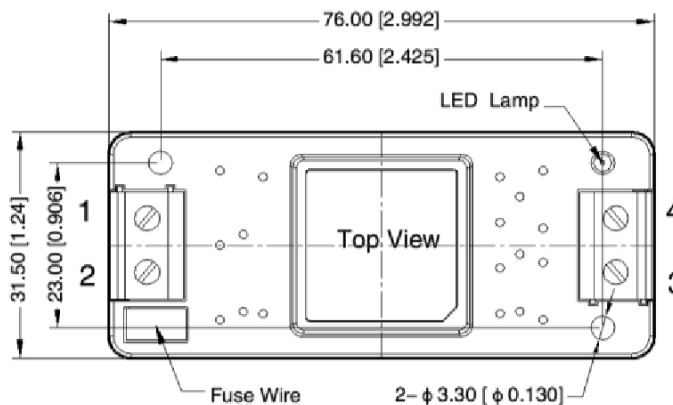

units: mm [inch]
 wire range: 24~12 AWG
 tightening torque: Max 0.4 N·m
 mounting rail: TS35, must be connected to safety ground
 tolerance: ±1.0 [±0.039]

| PIN CONNECTIONS | |
|-----------------|----------|
| PIN | Function |
| 1 | AC(N) |
| 2 | AC(L) |
| 3 | -Vo |
| 4 | +Vo |

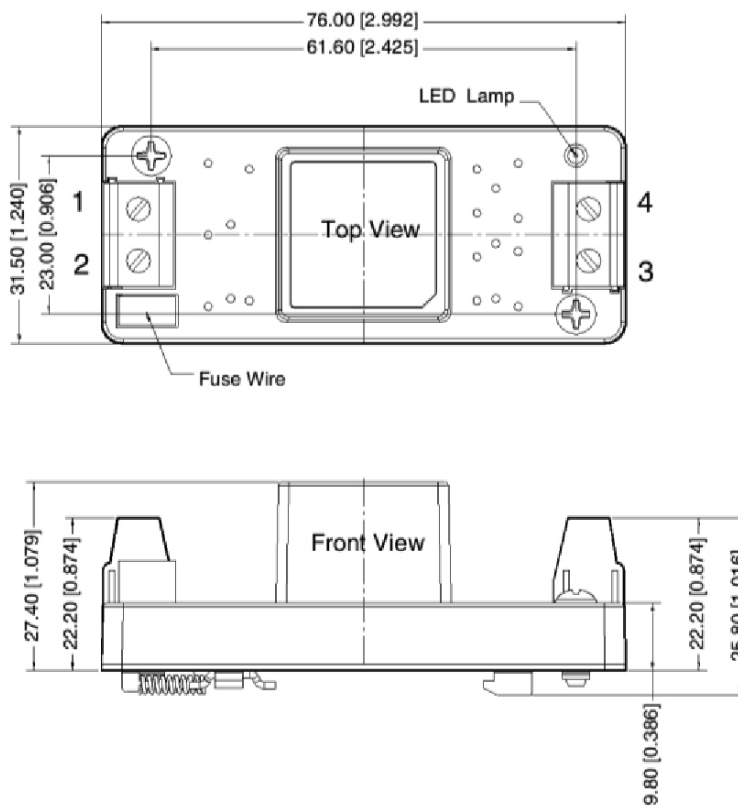

APPLICATION DESIGN REFERENCE

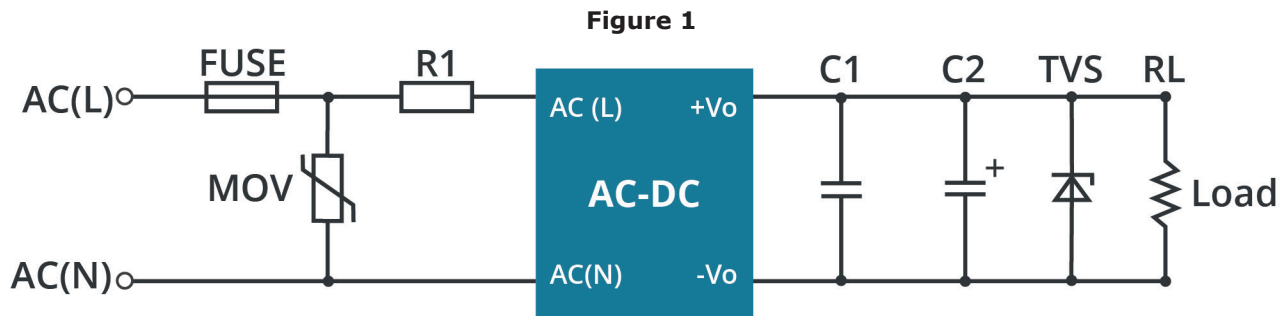

Table 1

| Part No. | C1(μF) | C2(μF) | FUSE | R1 | TVS | MOV |
|-----------|--------|--------|------------------------------------|--------|---------|---------|
| PSK-3D-3 | 1 | 150 | 1A/300V, slow-blow, required | 12Ω/3W | SMBJ7A | S10K350 |
| PSK-3D-5 | | 150 | | | SMBJ7A | |
| PSK-3D-9 | | 120 | | | SMBJ12A | |
| PSK-3D-12 | | 120 | | | SMBJ20A | |
| PSK-3D-15 | | 120 | | | SMBJ20A | |
| PSK-3D-24 | | 68 | | | SMBJ30A | |

Output Filtering Components:

An electrolytic capacitor with high frequency operation, low ESR, and at least 20% margin on rated output voltage is recommended for C2. C1 should be a ceramic capacitor and the TVS will help protect downstream electronics in the unlikely event of converter failure.

EMC RECOMMENDED CIRCUIT

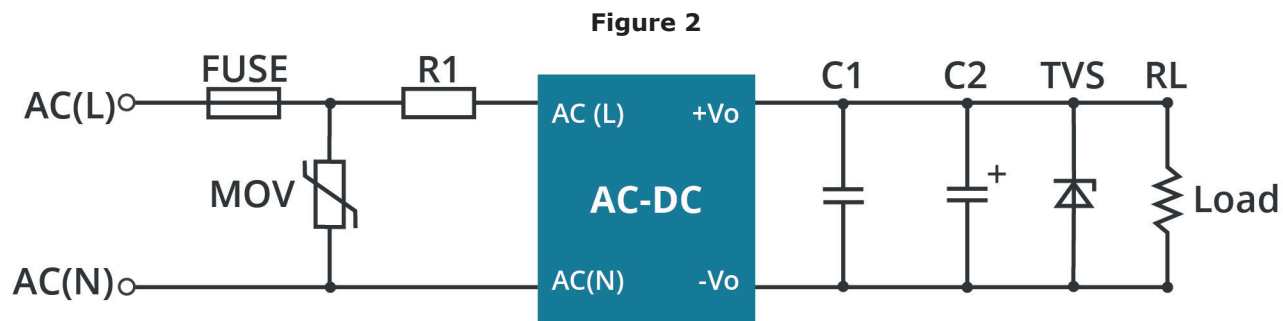

Note: EMC application circuit with higher requirements.

Table 2

| Components | Recommended Value |
|------------|------------------------------|
| MOV | S14K350 |
| R1 | 33Ω/3W |
| FUSE | 2A/300V, slow-blow, required |

DERATING CURVE

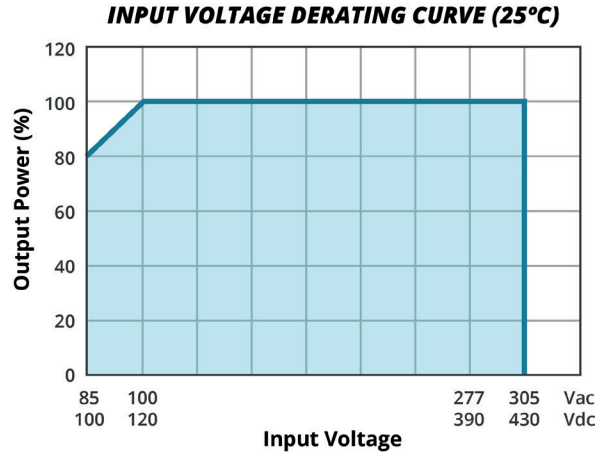
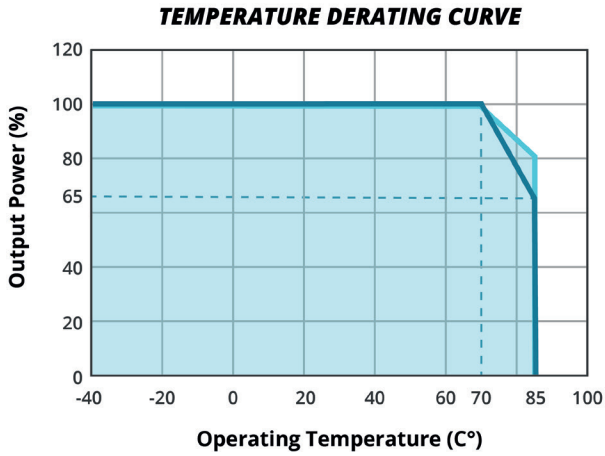

Note: 1. With an AC input between 85~100Vac and DC input between 100~120Vdc, the output power must be derated as per temperature derating curves.
 2. This product is suitable for applications using natural air cooling; for applications in closed environment please consult with CUI.

EFFICIENCY CURVES

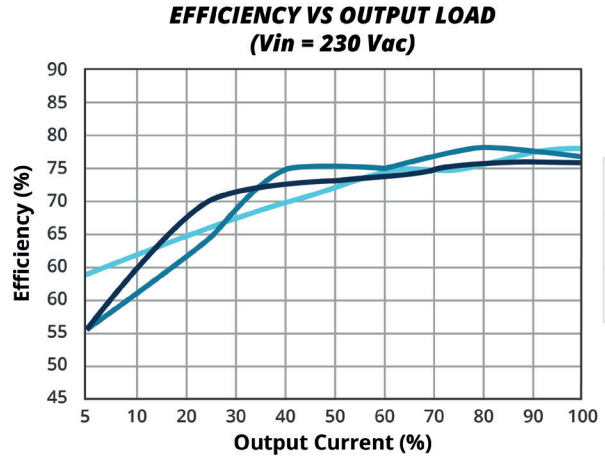
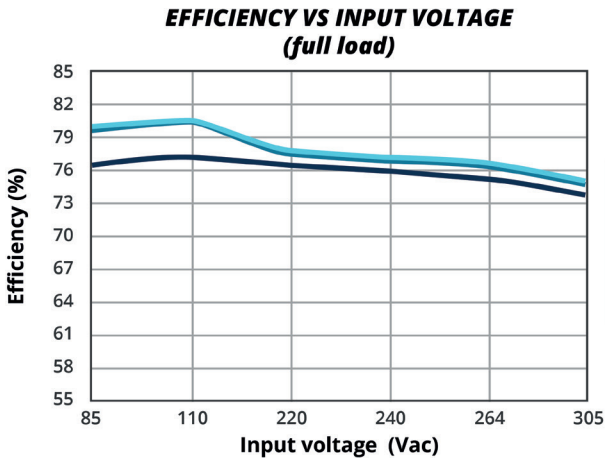

REVISION HISTORY

| rev. | description | date |
|------|-----------------------------------|------------|
| 1.0 | initial release | 01/28/2021 |
| 1.01 | derating curves updated | 01/19/2022 |
| 1.02 | no load power consumption updated | 05/03/2022 |
| 1.03 | UKCA mark added | 06/13/2022 |

The revision history provided is for informational purposes only and is believed to be accurate.



Headquarters
20050 SW 112th Ave.
Tualatin, OR 97062
800.275.4899

Fax 503.612.2383
cui.com
techsupport@cui.com

CUI offers a two (2) year limited warranty. Complete warranty information is listed on our website.

CUI reserves the right to make changes to the product at any time without notice. Information provided by CUI is believed to be accurate and reliable. However, no responsibility is assumed by CUI for its use, nor for any infringements of patents or other rights of third parties which may result from its use.

CUI products are not authorized or warranted for use as critical components in equipment that requires an extremely high level of reliability. A critical component is any component of a life support device or system whose failure to perform can be reasonably expected to cause the failure of the life support device or system, or to affect its safety or effectiveness.