

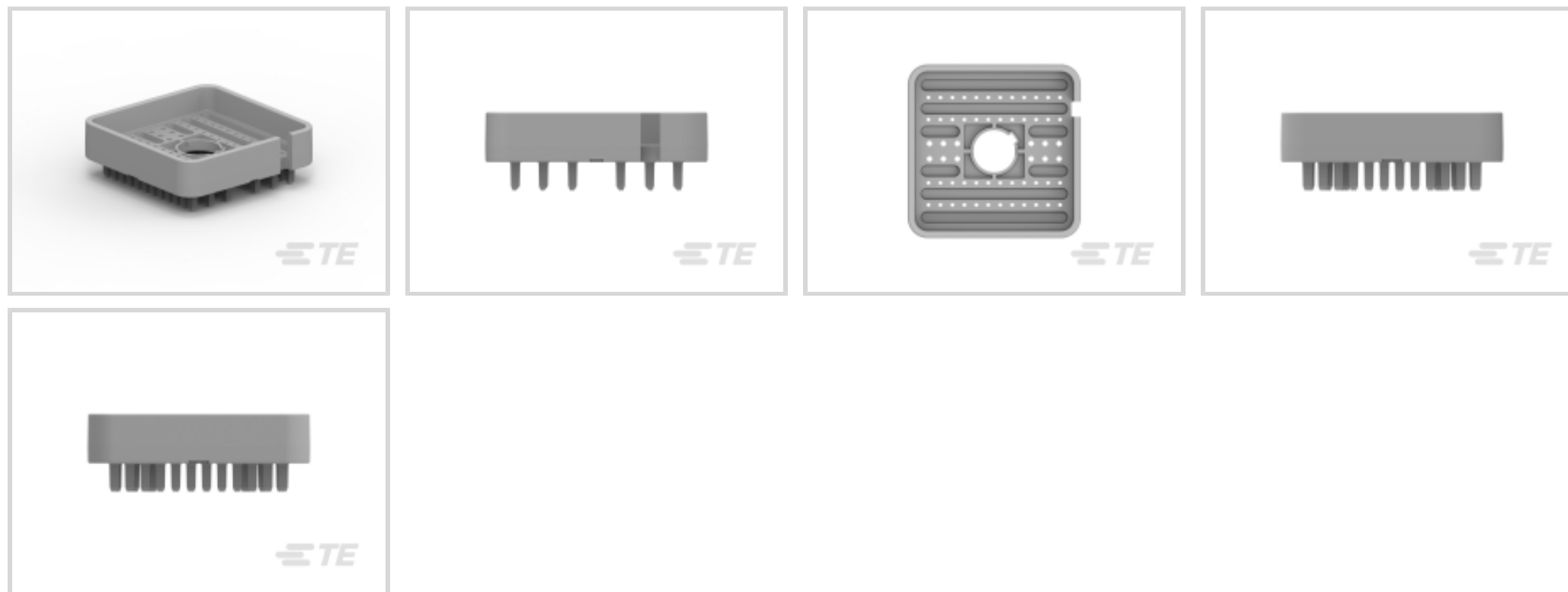

Connectors > Automotive Connectors > Automotive Connector Accessories > Automotive Connector Locks & Position Assurance >

DEUTSCH DRB Wedgelocks



Connector & Contact Retention Accessory Type: **Secondary Lock**

Primary Product Color: **Gray**

Primary Product Material: **PBT**

Number of Positions: **60**

Sealable: **No**

[All DEUTSCH DRB Wedgelocks \(20\)](#)

Features

Product Type Features

Connector & Contact Retention Accessory Type	Secondary Lock
Sealable	No

Configuration Features

Number of Positions	60
---------------------	----

Body Features

Primary Product Color	Gray
Primary Product Material	PBT

Usage Conditions

Operating Temperature Range	-55 – 125 °C[-67 – 257 °F]
-----------------------------	----------------------------

Industry Standards

UL Flammability Rating	UL 94HB
------------------------	---------



Packaging Features

Packaging Quantity	216
Packaging Method	Box

Other

Serviceable	Yes
-------------	-----

Product Compliance

[For compliance documentation, visit the product page on TE.com>](#)

EU RoHS Directive 2011/65/EU	Compliant
EU ELV Directive 2000/53/EC	Compliant
China RoHS 2 Directive MIIT Order No 32, 2016	No Restricted Materials Above Threshold
EU REACH Regulation (EC) No. 1907/2006	Current ECHA Candidate List: JUNE 2023 (235) Candidate List Declared Against: JAN 2023 (233) Does not contain REACH SVHC
Halogen Content	Not Low Halogen - contains Br or Cl > 900 ppm.
Solder Process Capability	Not reviewed for solder process capability

Product Compliance Disclaimer

This information is provided based on reasonable inquiry of our suppliers and represents our current actual knowledge based on the information they provided. This information is subject to change. The part numbers that TE has identified as EU RoHS compliant have a maximum concentration of 0.1% by weight in homogenous materials for lead, hexavalent chromium, mercury, PBB, PBDE, DBP, BBP, DEHP, DIBP, and 0.01% for cadmium, or qualify for an exemption to these limits as defined in the Annexes of Directive 2011/65/EU (RoHS2). Finished electrical and electronic equipment products will be CE marked as required by Directive 2011/65/EU. Components may not be CE marked. Additionally, the part numbers that TE has identified as EU ELV compliant have a maximum concentration of 0.1% by weight in homogenous materials for lead, hexavalent chromium, and mercury, and 0.01% for cadmium, or qualify for an exemption to these limits as defined in the Annexes of Directive 2000/53/EC (ELV). Regarding the REACH Regulation, the information TE provides on SVHC in articles for this part number is based on the latest European Chemicals Agency (ECHA) 'Guidance on requirements for substances in articles' posted at this URL: <https://echa.europa.eu/guidance-documents/guidance-on-reach>

Compatible Parts

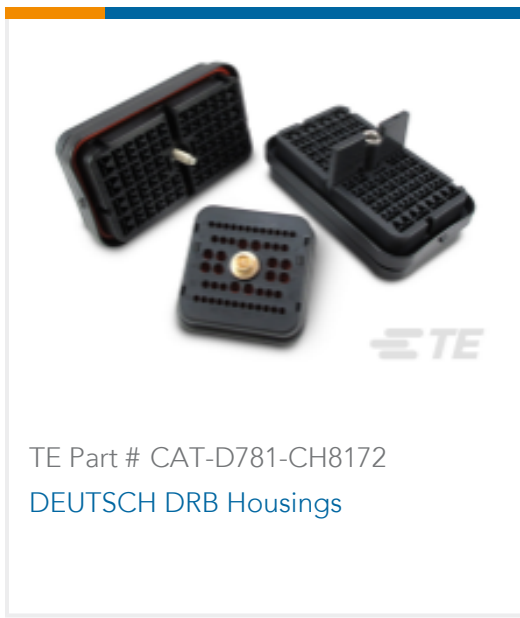

Also in the Series | DEUTSCH DRB

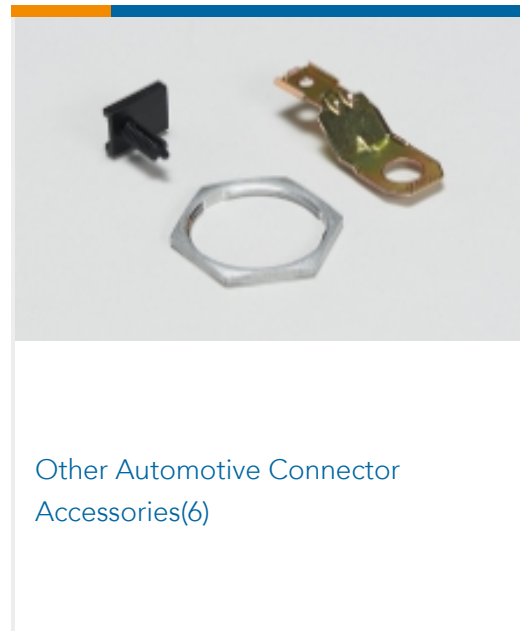
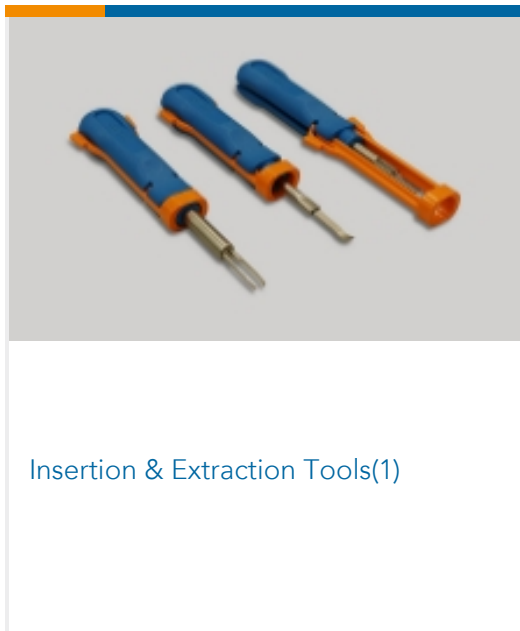
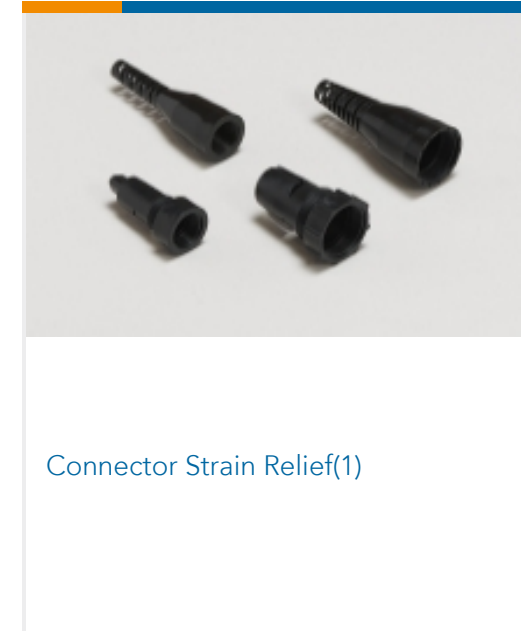
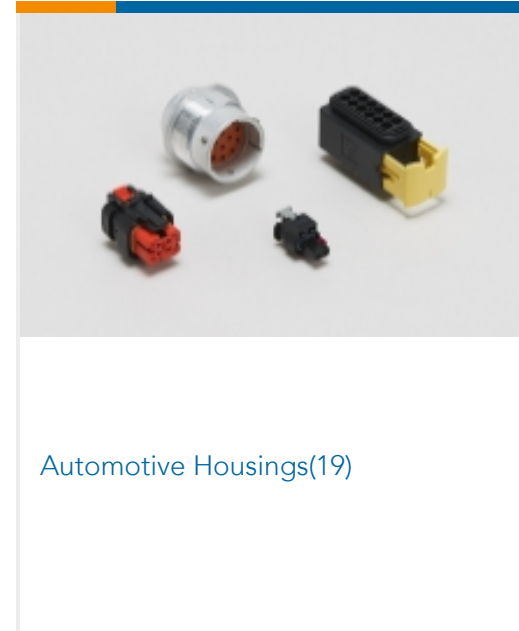
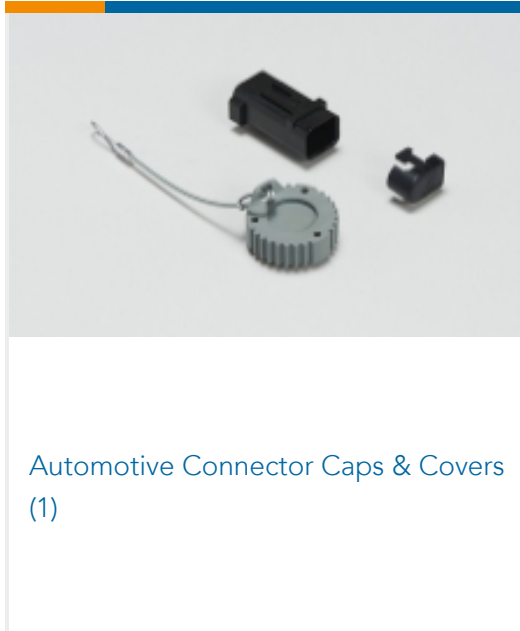

Customers Also Bought

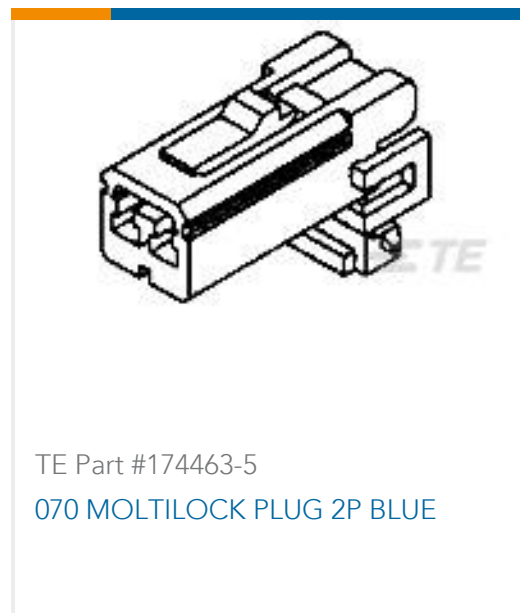



Documents

Product Drawings

[WEDGE LOCK, 60P, REC, GRY, DRB, A](#)

English

[WEDGE LOCK, 60P, REC, GRY, DRB, A](#)

English

CAD Files

Customer View Model

[ENG_CVM_CVM_WB-60PA_99.2d_dxf.zip](#)

English

3D PDF

3D

Customer View Model

[ENG_CVM_CVM_WB-60PA_99.3d_igs.zip](#)

English

Customer View Model

[ENG_CVM_CVM_WB-60PA_99.3d_stp.zip](#)

English

By downloading the CAD file I accept and agree to the [Terms and Conditions](#) of use.

Datasheets & Catalog Pages

[ICT Terminals and Connectors Catalogue](#)

English

[CONNECTOR SELECTOR](#)

English

Product Specifications

[Application Specification](#)

English

Agency Approvals

[UL Report](#)

English