

T2111082101-000 ✓ ACTIVE

HDC | HDC HMN

TE Internal #: T2111082101-000

Rectangular Contact Inserts, Insert for Contacts, Pin, 8 Pole Configuration, Crimp Terminal, 8 Position, 26 – 12 AWG Wire Size, HDC HMN

[View on TE.com >](#)



Connectors > Rectangular Connectors > Rectangular Contact Inserts

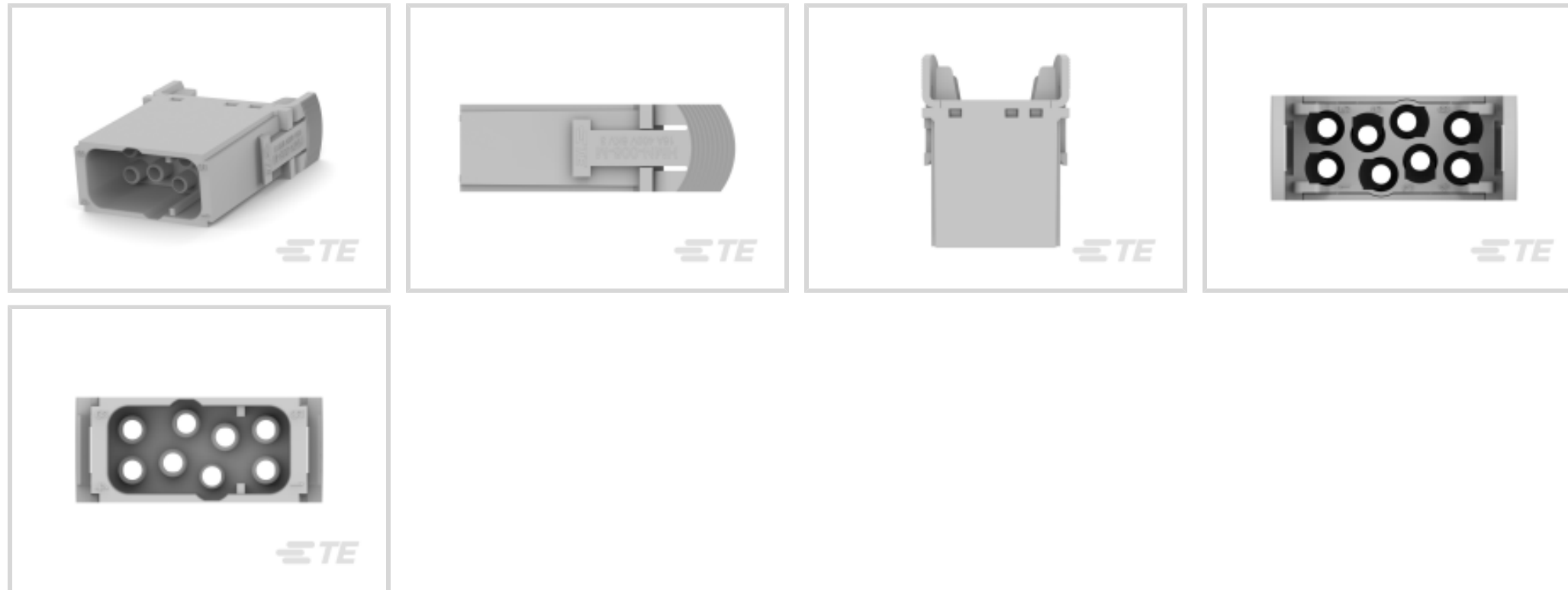

Rectangular Connector Insert Type: **Insert for Contacts**

Contact Type: **Pin**

Pole Configuration: **8**

Termination Method to Wire & Cable: **Crimp Terminal**

Number of Positions: **8**

Features

Product Type Features

Rectangular Connector Insert Type	Insert for Contacts
Sealable	No

Configuration Features

Number of Positions	8
---------------------	---

Contact Features

Contact Type	Pin
Pole Configuration	8
Contact Current Rating (Max)	16 A

Termination Features

Termination Method to Wire & Cable	Crimp Terminal
------------------------------------	----------------

Dimensions

Wire Size	.14 – 4 mm ²
-----------	-------------------------

Operation/Application



Circuit Application	Power & Signal
---------------------	----------------

Product Compliance

[For compliance documentation, visit the product page on TE.com>](#)

EU RoHS Directive 2011/65/EU	Compliant
EU ELV Directive 2000/53/EC	Compliant
China RoHS 2 Directive MIIT Order No 32, 2016	No Restricted Materials Above Threshold
EU REACH Regulation (EC) No. 1907/2006	Current ECHA Candidate List: JUNE 2023 (235) Candidate List Declared Against: JUNE 2023 (235) Does not contain REACH SVHC
Halogen Content	Low Bromine/Chlorine - Br and Cl < 900 ppm per homogenous material. Also BFR /CFR/PVC Free
Solder Process Capability	Not reviewed for solder process capability

















Product Compliance Disclaimer

This information is provided based on reasonable inquiry of our suppliers and represents our current actual knowledge based on the information they provided. This information is subject to change. The part numbers that TE has identified as EU RoHS compliant have a maximum concentration of 0.1% by weight in homogenous materials for lead, hexavalent chromium, mercury, PBB, PBDE, DBP, BBP, DEHP, DIBP, and 0.01% for cadmium, or qualify for an exemption to these limits as defined in the Annexes of Directive 2011/65/EU (RoHS2). Finished electrical and electronic equipment products will be CE marked as required by Directive 2011/65/EU. Components may not be CE marked. Additionally, the part numbers that TE has identified as EU ELV compliant have a maximum concentration of 0.1% by weight in homogenous materials for lead, hexavalent chromium, and mercury, and 0.01% for cadmium, or qualify for an exemption to these limits as defined in the Annexes of Directive 2000/53/EC (ELV). Regarding the REACH Regulation, the information TE provides on SVHC in articles for this part number is based on the latest European Chemicals Agency (ECHA) 'Guidance on requirements for substances in articles' posted at this URL: <https://echa.europa.eu/guidance-documents/guidance-on-reach>





Compatible Parts

 <p>TE Part # T2070104001-000 H10BN-T3</p>	 <p>TE Part # T2111082201-000 HMN-008-F</p>	 <p>TE Part # T2070064001-000 H6BN-T2</p>	 <p>TE Part # T2070164001-000 H16BN-T4</p>
---	--	--	---

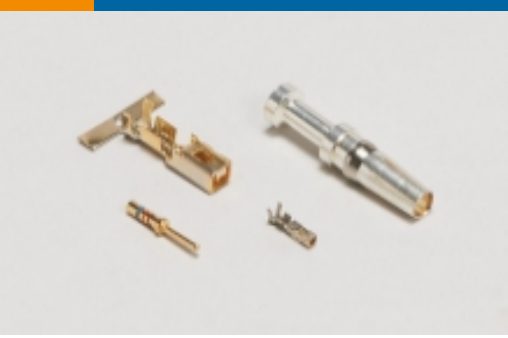

 <p>TE Part # T2030011005-000 DEM-0.5</p>	 <p>TE Part # T2030011008-000 DEM-0.75</p>	 <p>TE Part # T2030011010-000 DEM-1.0</p>	 <p>TE Part # T2030011015-000 DEM-1.5</p>
 <p>TE Part # T2030011025-000 DEM-2.5</p>	 <p>TE Part # T2030011040-000 DEM-4.0</p>	 <p>TE Part # T2071104101-000 H10BP-T3-M DOCKING FRAME_FLOATING</p>	 <p>TE Part # T2079104101-000 H10A-T1-M</p>
 <p>TE Part # T2070104101-000 H10BN-T3-M</p>	 <p>TE Part # T2070064101-000 H6BN-T2-M</p>	 <p>TE Part # T2030011002-000 DEM-0.3</p>	 <p>TE Part # T1310060125-000 H6B-TS-M25</p>
 <p>TE Part # T3609250102-000 DLX-25-M</p>	 <p>TE Part # T1010061200-000 H6B-KDTP</p>	 <p>TE Part # T2030001040-000 CEM-4.0</p>	 <p>TE Part # T2030011030-000 DEM-3.0</p>

Also in the Series | **HDC HMN**

 <p>Connector Contacts(2)</p>	 <p>Insertion & Extraction Tools(1)</p>	 <p>Rectangular Connector Hardware(16)</p>	 <p>Rectangular Contact Inserts(119)</p>
--	---	---	---

Customers Also Bought



Documents

Product Drawings

[HMN-008-M](#)

English

CAD Files

[3D PDF](#)

3D

Customer View Model

[ENG_CVM_CVM_T2111082101-000_B.2d_dxf.zip](#)

English

Customer View Model

[ENG_CVM_CVM_T2111082101-000_B.3d_igs.zip](#)

English

Customer View Model

[ENG_CVM_CVM_T2111082101-000_B.3d_stp.zip](#)

English

By downloading the CAD file I accept and agree to the [Terms and Conditions](#) of use.

Datasheets & Catalog Pages

[Heavy Duty Connectors](#)

English

[HEAVY DUTY CONNECTORS](#)

English

Product Specifications

[Application Specification](#)

English

T2111082101-000

Rectangular Contact Inserts, Insert for Contacts, Pin, 8 Pole Configuration, Crimp Terminal, 8 Position, 26 – 12 AWG Wire Size, HDC HMN

