

# HDP26-24-7SN-C038 ✓ ACTIVE

DEUTSCH | DEUTSCH HD, DEUTSCH HDP

TE Internal #: HDP26-24-7SN-C038

Housing for Female Terminals, Wire-to-Wire, 7 Position, Sealable, Black, Wire & Cable, Power & Signal, Cable Mount (Free-Hanging), Hybrid

[View on TE.com >](#)



Connectors > Automotive Connectors > Automotive Housings > DEUTSCH HDP20 Housings



Connector System: **Wire-to-Wire**

Number of Positions: 7

Connector & Housing Type: **Housing for Female Terminals**

Sealable: **Yes**

Mating Pin Diameter: 1.59 mm, 5.72 mm [ .063 in, .225 in ]

[All DEUTSCH HDP20 Housings \(324\)](#)

## Features

### Product Type Features

Mixed & Hybrid Connector	Yes
Connector Shape	Circular
Connector System	Wire-to-Wire
Connector & Housing Type	Housing for Female Terminals
Sealable	Yes
Connector & Contact Terminates To	Wire & Cable
Primary Locking Feature	Contact Retainer

### Configuration Features

Blank Cavity Position	0
Connector Seal Code	N Seal
Number of Positions	7

### Electrical Characteristics

Operating Voltage	250 VAC
Nominal Voltage Architecture	12 V, 24 V, 48 V

### Body Features

Cable Exit Angle	180°
Primary Product Color	Black



### Contact Features

Contact Size	Size 16, Size 4
Contact Type	Socket
Mating Pin Diameter	1.59 mm, 5.72 mm [.063 in] [.225 in]
Contact Current Rating (Max)	13 A, 100 A

### Mechanical Attachment

Terminal Position Assurance	No
Strain Relief	Add By Accessory
Mating Alignment Type	Guide Slot
Mating Alignment	With
Connector Mounting Type	Cable Mount (Free-Hanging)

### Housing Features

Housing Material	PA GF
------------------	-------

### Dimensions

Connector Height	49.53 mm [1.95 in]
Product Width	49.53 mm [1.95 in]
Product Length	38.63 mm [1.521 in]
Compatible Insulation Diameter Range	2.54 – 3.4 mm, 7.9 – 10.67 mm [.1 – .134 in] [.311 – .42 in]

### Usage Conditions

Operating Temperature (Max)	125 °C [257 °F]
Operating Temperature Range	-55 – 125 °C [-67 – 257 °F]

### Operation/Application

Circuit Application	Power & Signal
---------------------	----------------

### Industry Standards

Degree of Protection	IP67
UL Flammability Rating	20mm Flame Test per Standard UL-94

### Packaging Features

Packaging Method	Box
------------------	-----

### Other

Serviceable	Yes
-------------	-----

Connector Position Assurance Capable

No

## Product Compliance

For compliance documentation, visit the [product page on TE.com](#)>

EU RoHS Directive 2011/65/EU	Compliant
EU ELV Directive 2000/53/EC	Compliant
China RoHS 2 Directive MIIT Order No 32, 2016	No Restricted Materials Above Threshold
EU REACH Regulation (EC) No. 1907/2006	<p>Current ECHA Candidate List: JUNE 2023 (235)</p> <p>Candidate List Declared Against: JUNE 2023 (235)</p> <p>SVHC &gt; Threshold:</p> <p>Octamethylcyclotetrasiloxane (D4) (.5% in Component Part)</p> <p>Dodecamethylcyclohexasiloxane (D6) (.5% in Component Part)</p> <p>Decamethylcyclopentasiloxane (D5) (.5% in Component Part)</p> <p><b>Article Safe Usage Statements:</b> Wash thoroughly after handling. Recycle if possible and dispose of the article by following all applicable governmental regulations relevant to your geographic location.</p>
Halogen Content	Not Low Halogen - contains Br or Cl > 900 ppm.
Solder Process Capability	Not reviewed for solder process capability

### Product Compliance Disclaimer

This information is provided based on reasonable inquiry of our suppliers and represents our current actual knowledge based on the information they provided. This information is subject to change. The part numbers that TE has identified as EU RoHS compliant have a maximum concentration of 0.1% by weight in homogenous materials for lead, hexavalent chromium, mercury, PBB, PBDE, DBP, BBP, DEHP, DIBP, and 0.01% for cadmium, or qualify for an exemption to these limits as defined in the Annexes of Directive 2011/65/EU (RoHS2). Finished electrical and electronic equipment products will be CE marked as required by Directive 2011/65/EU. Components may not be CE marked. Additionally, the part numbers that TE has identified as EU ELV compliant have a maximum concentration of 0.1% by weight in homogenous materials for lead, hexavalent chromium, and mercury, and 0.01% for cadmium, or qualify for an exemption to these limits as defined in the Annexes of Directive 2000/53/EC (ELV). Regarding the REACH Regulation, the information TE provides on SVHC in articles for this part number is based on the latest European Chemicals Agency (ECHA) 'Guidance on requirements for substances in articles' posted at this URL: <https://echa.europa.eu/guidance-documents/guidance-on-reach>

## Compatible Parts

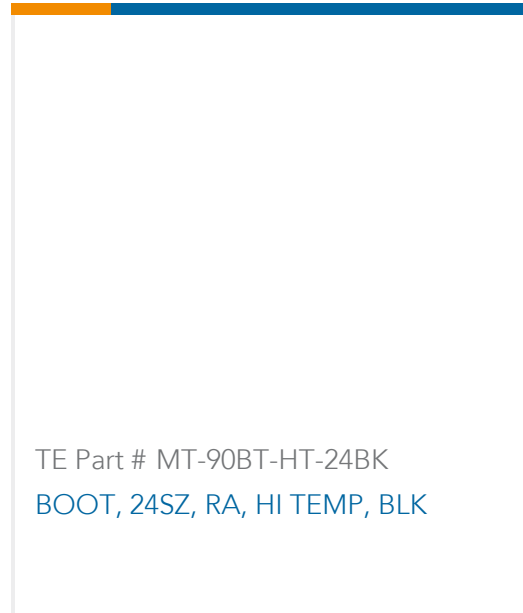
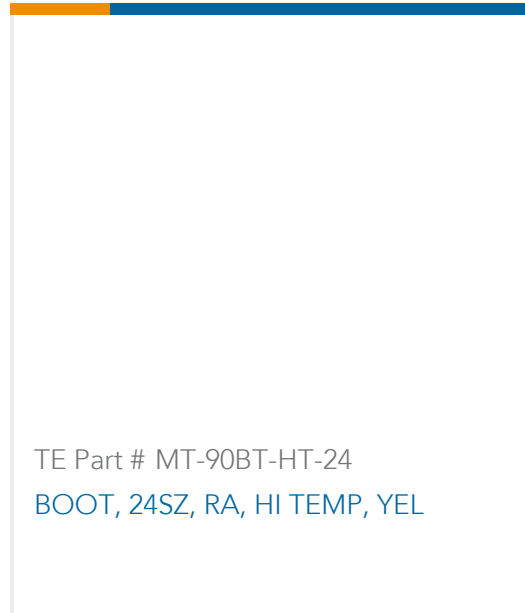
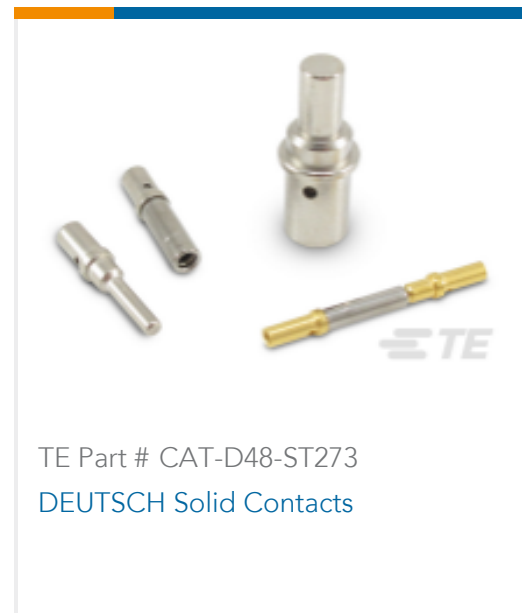

Also in the Series | **DEUTSCH HD**

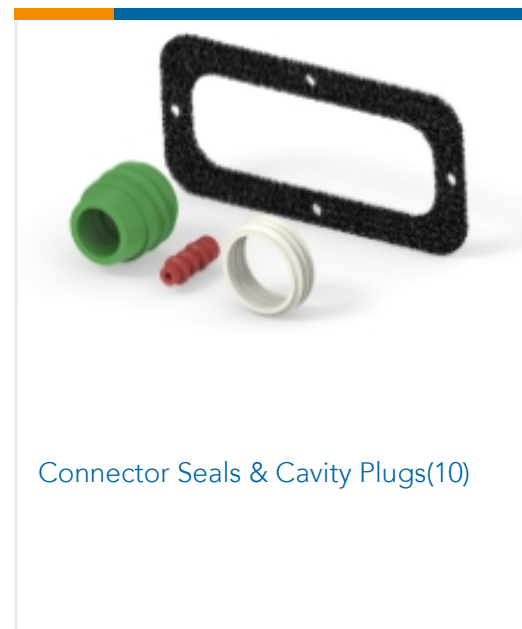
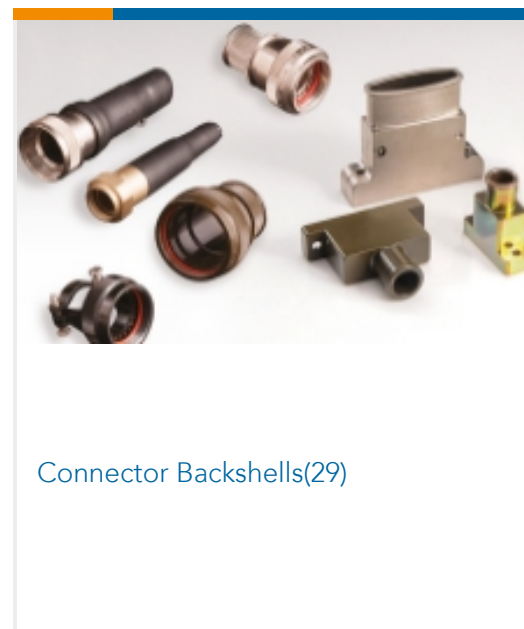
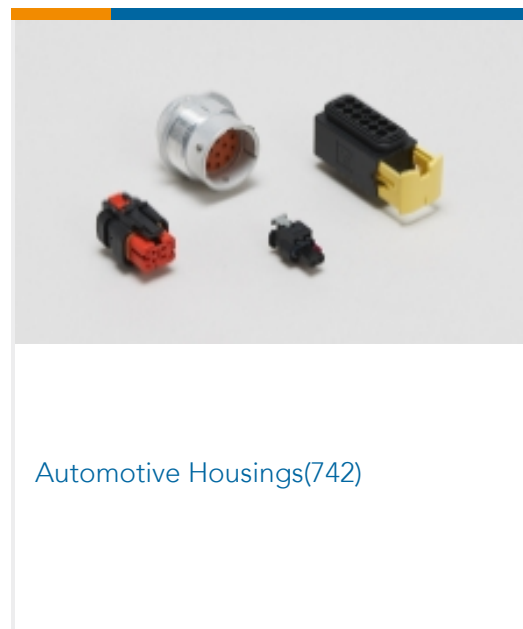
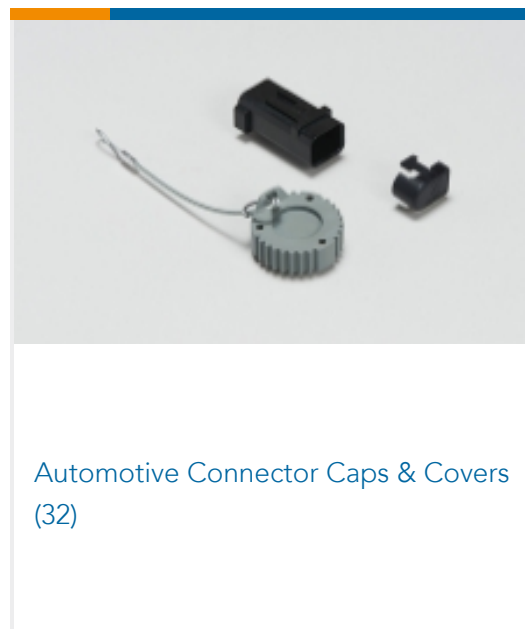



Connector Strain Relief(5)



Insertion & Extraction Tools(11)



Other Automotive Connector Accessories(11)

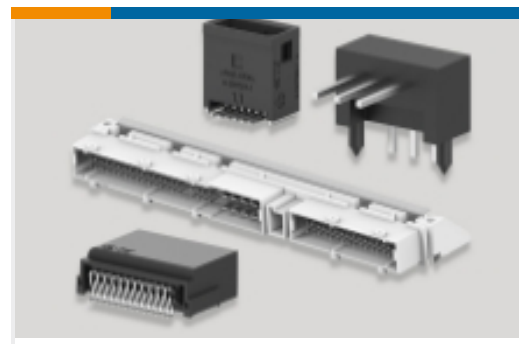

PCB Headers & Receptacles(1)

Also in the Series | **DEUTSCH HDP**



Automotive Connector Caps & Covers (4)

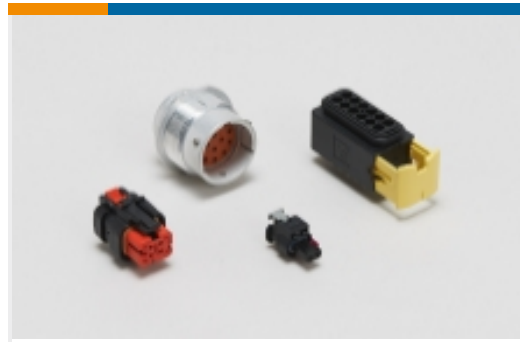

Automotive Housings(331)



Connector Backshells(8)



Connector Seals & Cavity Plugs(1)



Insertion & Extraction Tools(11)



Other Automotive Connector Accessories(5)

Customers Also Bought



TE Part #DT04-12PA-B016  
DEUTSCH DT Receptacle Connectors



TE Part #1871412-1  
AMPSEAL16,CAP ASSY,2P-A,B/R TYPE,  
RWDS,



TE Part #3-963217-1  
16 J-P-T GEH KOMPL



TE Part #1747731-2  
0.64/1.0 SEALED 49POS PLUG ASSY,  
B KEY



TE Part #W6P-P004  
WEDGE LOCK

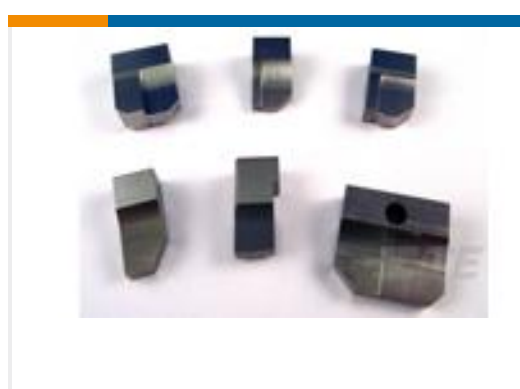

TE Part #9-683403-1  
ANVIL, COMBINATION

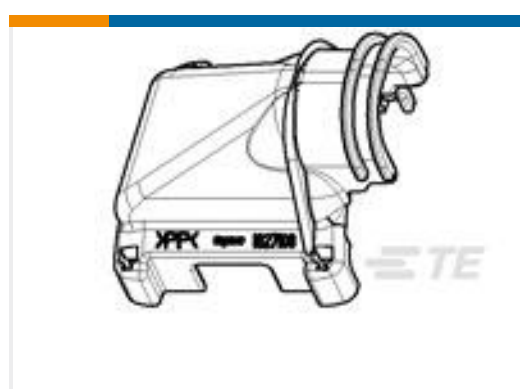

TE Part #1827108-1  
025/040 44POS COVER A-TYPE



TE Part #776665-1  
Wire Cover, V Type, 49 Position

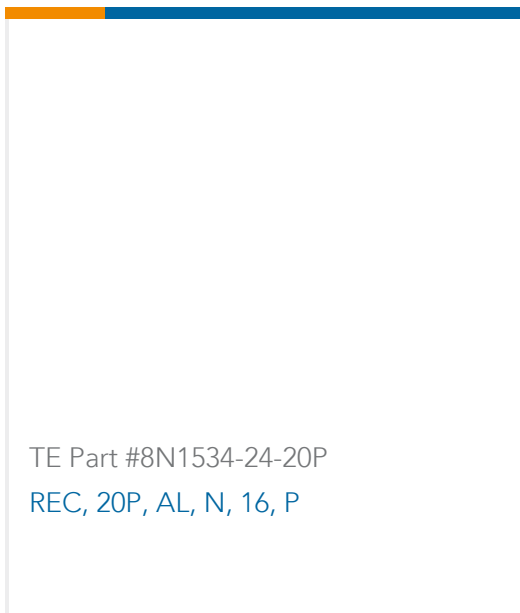

## Documents

### Product Drawings

[PLG, 7P, BLK, N, 4AWG, 4/16, S](#)

English

### CAD Files

[3D PDF](#)

3D

Customer View Model

[ENG\\_CVM\\_CVM\\_HDP26-24-7SN-C038\\_B.2d\\_dxf.zip](#)

English

Customer View Model

[ENG\\_CVM\\_CVM\\_HDP26-24-7SN-C038\\_B.3d\\_igs.zip](#)

English

Customer View Model

[ENG\\_CVM\\_CVM\\_HDP26-24-7SN-C038\\_B.3d\\_stp.zip](#)

English

By downloading the CAD file I accept and agree to the [Terms and Conditions](#) of use.

### Datasheets & Catalog Pages

[ICT Terminals and Connectors Catalogue](#)

English

[CONNECTOR SELECTOR](#)

English

### Product Specifications

[Application Specification](#)

English

### Agency Approvals

[UL Report](#)

English