

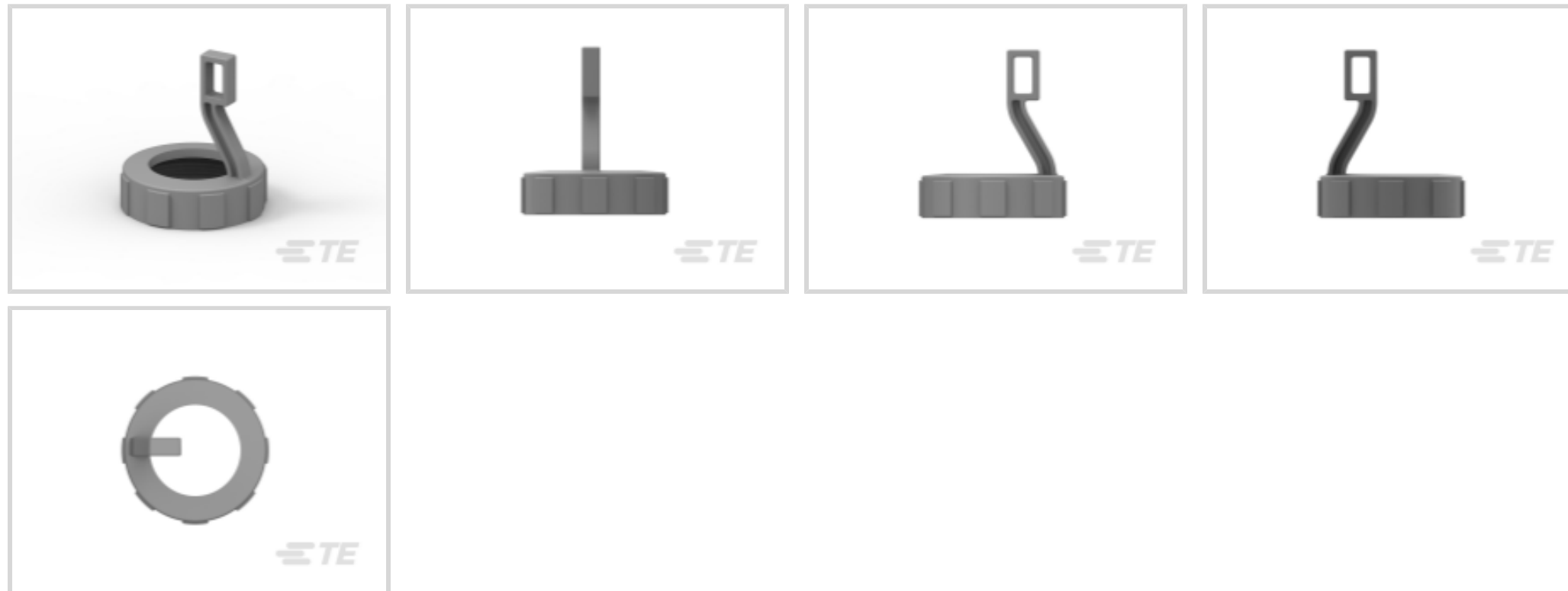

Connectors > Connector Accessories > Connector Backshells > DEUTSCH HD10 Backshells



Connector Backshell Product Type: **Backshell**

Primary Product Material: **PA GF**

Number of Positions: **9**

Sealable: **No**

Operating Temperature Range: **-55 – 125 °C [-67 – 257 °F]**

[All DEUTSCH HD10 Backshells \(17\)](#)

Features

Product Type Features

Connector Backshell Product Type	Backshell
Sealable	No

Configuration Features

Number of Positions	9
---------------------	---

Body Features

Cable Exit Angle	180°
Primary Product Color	Gray
Primary Product Material	PA GF

Dimensions

Compatible Cable Diameter Range	0 – 25.4 mm[0 – 1 in]
---------------------------------	-----------------------

Usage Conditions

Operating Temperature (Max)	125 °C[257 °F]
Operating Temperature Range	-55 – 125 °C[-67 – 257 °F]



Industry Standards

IP Rating	IP6K9K
UL Flammability Rating	UL 94V-0

Packaging Features

Packaging Quantity	1
Packaging Method	Box

Other

Serviceable	Yes
-------------	-----

Product Compliance

[For compliance documentation, visit the product page on TE.com>](#)

EU RoHS Directive 2011/65/EU	Compliant
EU ELV Directive 2000/53/EC	Compliant
China RoHS 2 Directive MIIT Order No 32, 2016	No Restricted Materials Above Threshold
EU REACH Regulation (EC) No. 1907/2006	Current ECHA Candidate List: JUNE 2023 (235) Candidate List Declared Against: JUNE 2023 (235) Does not contain REACH SVHC
Halogen Content	Not Low Halogen - contains Br or Cl > 900 ppm.
Solder Process Capability	Not reviewed for solder process capability

Product Compliance Disclaimer

This information is provided based on reasonable inquiry of our suppliers and represents our current actual knowledge based on the information they provided. This information is subject to change. The part numbers that TE has identified as EU RoHS compliant have a maximum concentration of 0.1% by weight in homogenous materials for lead, hexavalent chromium, mercury, PBB, PBDE, DBP, BBP, DEHP, DIBP, and 0.01% for cadmium, or qualify for an exemption to these limits as defined in the Annexes of Directive 2011/65/EU (RoHS2). Finished electrical and electronic equipment products will be CE marked as required by Directive 2011/65/EU. Components may not be CE marked. Additionally, the part numbers that TE has identified as EU ELV compliant have a maximum concentration of 0.1% by weight in homogenous materials for lead, hexavalent chromium, and mercury, and 0.01% for cadmium, or qualify for an exemption to these limits as defined in the Annexes of Directive 2000/53/EC (ELV). Regarding the REACH Regulation, the information TE provides on SVHC in articles for this part number is based on the latest European Chemicals Agency (ECHA) 'Guidance on requirements for substances in articles' posted at this URL: <https://echa.europa.eu/guidance-documents/guidance-on-reach>

Compatible Parts



TE Part # CAT-H3910-CH8172
DEUTSCH HD10 Housings

Also in the Series | DEUTSCH HD

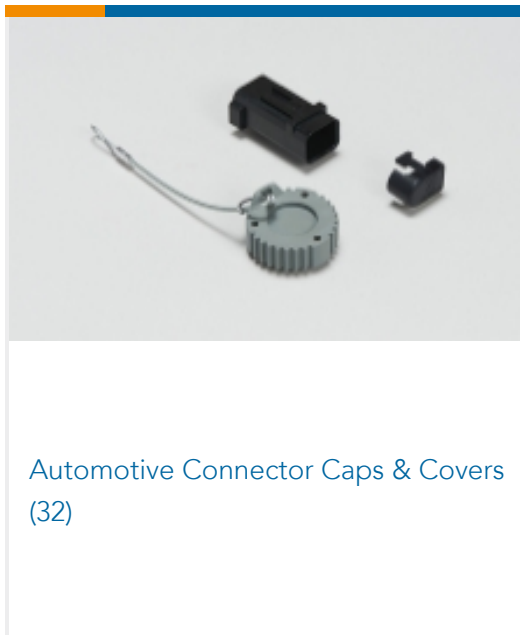

Automotive Connector Caps & Covers (32)

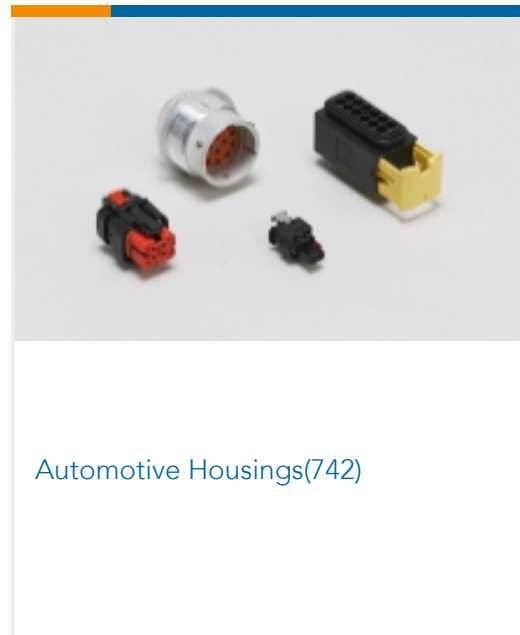

Automotive Housings(742)

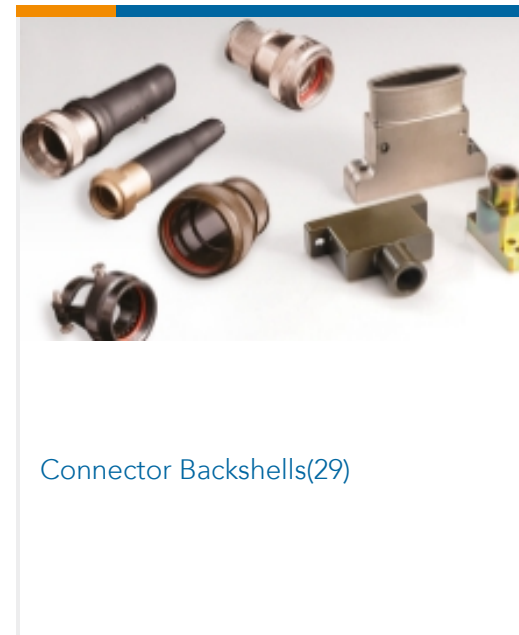

Connector Backshells(29)

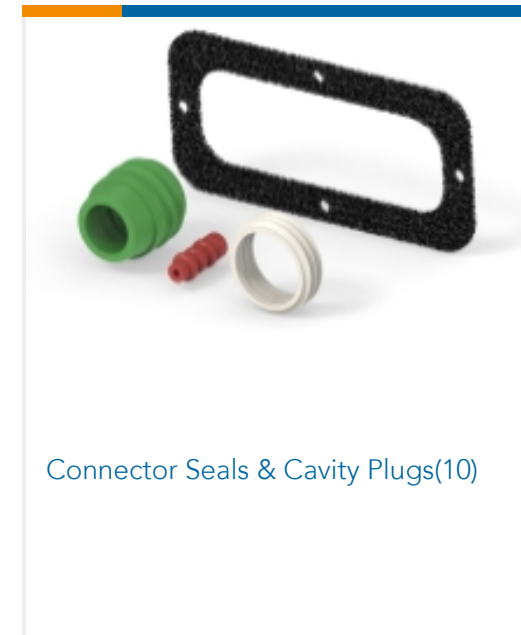

Connector Seals & Cavity Plugs(10)



Connector Strain Relief(5)

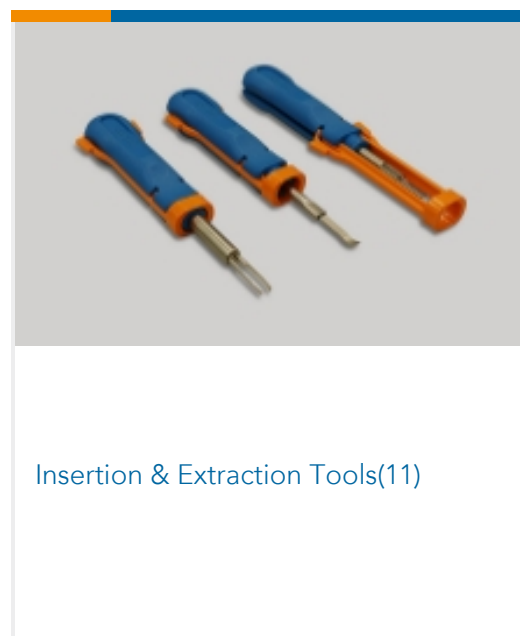

Insertion & Extraction Tools(11)

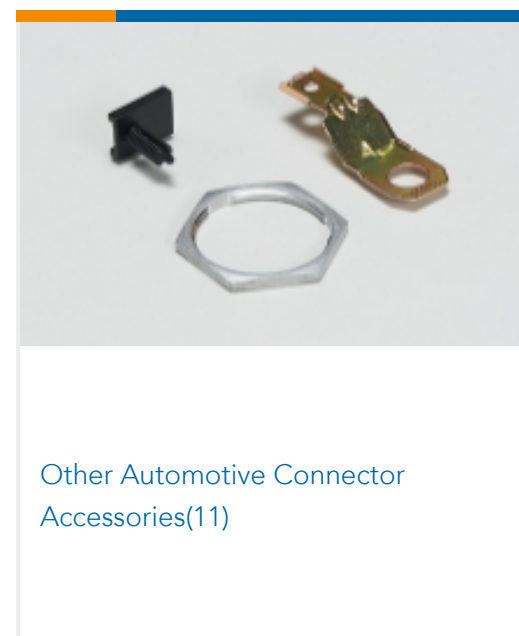

Other Automotive Connector Accessories(11)



PCB Headers & Receptacles(1)

Also in the Series | DEUTSCH HD10

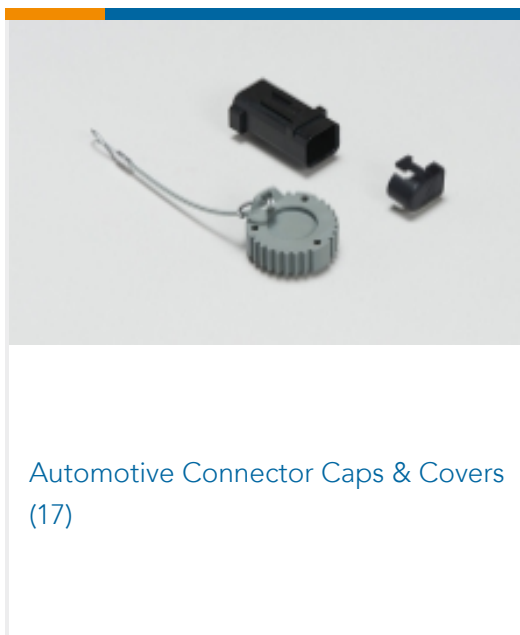

Automotive Connector Caps & Covers (17)

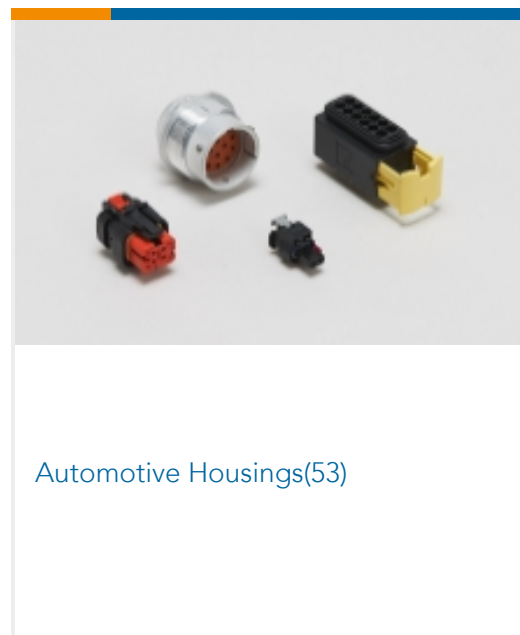

Automotive Housings(53)

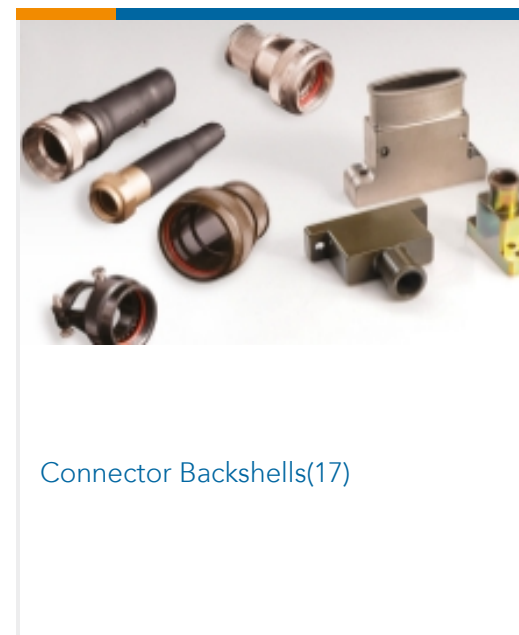

Connector Backshells(17)



PCB Headers & Receptacles(1)

Customers Also Bought

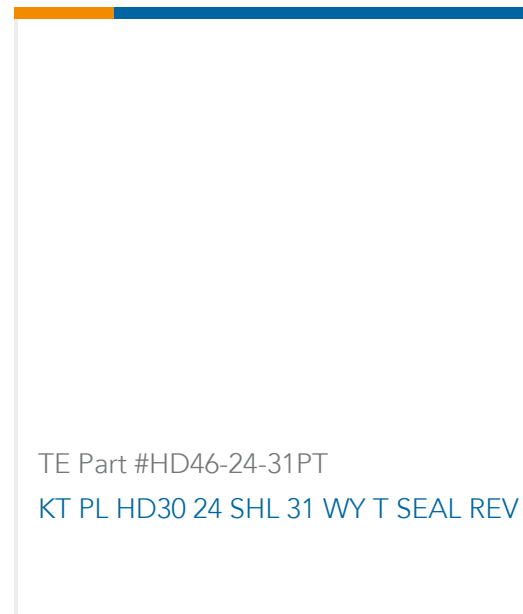
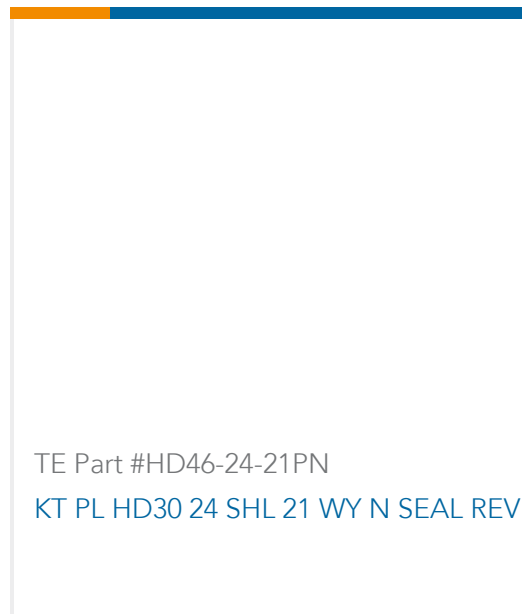
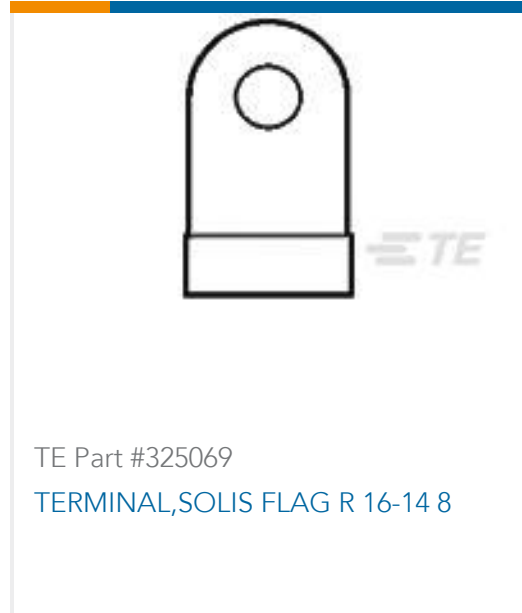

Documents

Product Drawings

BACK SHELL

English

CAD Files

3D PDF

3D

Customer View Model

[ENG_CVM_CVM_HD18-009_J_c-hd18-009-j.2d_dxf.zip](#)

English

Customer View Model

[ENG_CVM_CVM_HD18-009_J_c-hd18-009-j.3d_igs.zip](#)

English

Customer View Model

[ENG_CVM_CVM_HD18-009_J_c-hd18-009-j.3d_stp.zip](#)

English

By downloading the CAD file I accept and agree to the [Terms and Conditions](#) of use.

Datasheets & Catalog Pages



[ICT Terminals and Connectors Catalogue](#)

English

[CONNECTOR SELECTOR](#)

English

[Product Specifications](#)

[Engineering Report](#)

English