

# HD10-9-1939PE-P080 ✓ ACTIVE



DEUTSCH | DEUTSCH HD, DEUTSCH HD10

TE Internal #: HD10-9-1939PE-P080

Housing for Male Terminals, Wire-to-Wire, 9 Position, Sealable, Green, Wire & Cable, Power & Signal, Panel Mount, -67 – 257 °F [-55 – 125 °C], Hybrid

[View on TE.com >](#)

Connectors > Automotive Connectors > Automotive Housings > DEUTSCH HD10 Housings



Connector System: **Wire-to-Wire**

Number of Positions: **9**

Connector & Housing Type: **Housing for Male Terminals**

Sealable: **Yes**

Mating Pin Diameter: **1.59 mm [ .063 in ]**

[All DEUTSCH HD10 Housings \(53\)](#)

## Features

### Product Type Features

Mixed & Hybrid Connector	No
Connector Shape	Circular
Connector System	Wire-to-Wire
Connector & Housing Type	Housing for Male Terminals
Sealable	Yes
Connector & Contact Terminates To	Wire & Cable
Primary Locking Feature	Contact Retainer

### Configuration Features

Blank Cavity Position	0
Connector Seal Code	E Seal
Number of Positions	9

### Electrical Characteristics



Operating Voltage	250 VAC
-------------------	---------

Nominal Voltage Architecture	12 V, 24 V, 48 V
------------------------------	------------------

### Body Features

Cable Exit Angle	180°
------------------	------

Primary Product Color	Green
-----------------------	-------

### Contact Features

Contact Size	Size 16
--------------	---------

Contact Type	Pin
--------------	-----

Mating Pin Diameter	1.59 mm[.063 in]
---------------------	------------------

Contact Current Rating (Max)	13 A
------------------------------	------

### Mechanical Attachment

Terminal Position Assurance	No
-----------------------------	----

Strain Relief	Add By Accessory
---------------	------------------

Mating Alignment Type	Polarization Slot
-----------------------	-------------------

Mating Alignment	With
------------------	------

Connector Mounting Type	Panel Mount
-------------------------	-------------

### Housing Features

Housing Material	PA GF
------------------	-------

### Dimensions

Connector Height	36.5 mm[1.437 in]
------------------	-------------------

Product Width	36.5 mm[1.437 in]
---------------	-------------------

Product Length	42.18 mm[1.66 in]
----------------	-------------------

Compatible Insulation Diameter Range	1.35 – 3.05 mm[.053 – .12 in]
--------------------------------------	-------------------------------

### Usage Conditions

Operating Temperature (Max)	125 °C[257 °F]
-----------------------------	----------------

Operating Temperature Range	-55 – 125 °C[-67 – 257 °F]
-----------------------------	----------------------------

### Operation/Application

Circuit Application	Power & Signal
---------------------	----------------

### Industry Standards

Degree of Protection	IP68, IP6K9K
----------------------	--------------

UL Flammability Rating	UL 94V-1
------------------------	----------

### Packaging Features



Packaging Quantity	250
Packaging Method	Box

**Other**

Serviceable	Yes
Connector Position Assurance Capable	No

**Product Compliance**

[For compliance documentation, visit the product page on TE.com>](#)

EU RoHS Directive 2011/65/EU	Compliant
EU ELV Directive 2000/53/EC	Compliant
China RoHS 2 Directive MIIT Order No 32, 2016	No Restricted Materials Above Threshold
EU REACH Regulation (EC) No. 1907/2006	Current ECHA Candidate List: JUNE 2023 (235) Candidate List Declared Against: JUNE 2023 (235) SVHC > Threshold: Octamethylcyclotetrasiloxane (D4) (.5% in Component Part) Dodecamethylcyclohexasiloxane (D6) (.5% in Component Part) Decamethylcyclopentasiloxane (D5) (.5% in Component Part) <b>Article Safe Usage Statements:</b> Wash thoroughly after handling. Recycle if possible and dispose of the article by following all applicable governmental regulations relevant to your geographic location.
Halogen Content	Not Low Halogen - contains Br or Cl > 900 ppm.
Solder Process Capability	Not reviewed for solder process capability

**Product Compliance Disclaimer**

This information is provided based on reasonable inquiry of our suppliers and represents our current actual knowledge based on the information they provided. This information is subject to change. The part numbers that TE has identified as EU RoHS compliant have a maximum concentration of 0.1% by weight in homogenous materials for lead, hexavalent chromium, mercury, PBB, PBDE, DBP, BBP, DEHP, DIBP, and 0.01% for cadmium, or qualify for an exemption to these limits as defined in the Annexes of Directive 2011/65/EU (RoHS2). Finished electrical and electronic equipment products will be CE marked as required by Directive 2011/65/EU. Components may not be CE marked. Additionally, the part numbers that TE has identified as EU ELV compliant have a maximum concentration of 0.1% by weight in homogenous materials for lead, hexavalent chromium, and mercury, and 0.01% for cadmium, or qualify for an exemption to these limits as defined in the Annexes of Directive 2000/53/EC (ELV). Regarding the REACH Regulation, the information TE provides on SVHC in articles for this part number is based on the latest European Chemicals Agency (ECHA) 'Guidance on requirements for substances in articles' posted at this URL: <https://echa.europa.eu/guidance-documents/guidance-on-reach>

**Compatible Parts**



TE Part # CAT-H3910-CH8172  
DEUTSCH HD10 Housings



TE Part # HDC14-3  
DUST CAP



TE Part # CAT-D48-SP729  
DEUTSCH Sealing Plugs



TE Part # CAT-H3910-RC1748  
Receptacle Dust Caps — DEUTSCH HD10



TE Part # CAT-D48-ST273  
DEUTSCH Solid Contacts



TE Part # CAT-J67-DSCC16  
DEUTSCH Size 16 Crimp Contacts



TE Part # HD10-9BT-BK  
BOOT, 9P, PLG/REC, ST, BLK



TE Part # HD10-9BT  
BOOT, 9P, PLG/REC, ST, GRY



TE Part # HD10-9-GKT  
GASKET, 9SZ, BLK, HD10



TE Part # 2300908-1  
0460-003-16329, PIN, SOLID, 20-24AWG, AU



TE Part # 0411-336-1605  
EXT TOOL, SIZE 16, 16-20 AWG, E, DRK BLU



TE Part # CAT-D48-SFT273  
DEUTSCH Stamped and Formed Contacts



TE Part # HD10-9BT-BK-430  
BOOT, 9P, PLG/REC, ST, BLK

Also in the Series | **DEUTSCH HD**



Automotive Connector Caps & Covers (32)



Automotive Housings(742)



Connector Backshells(29)



Connector Seals & Cavity Plugs(10)





Connector Strain Relief(5)



Insertion & Extraction Tools(11)



Other Automotive Connector Accessories(11)

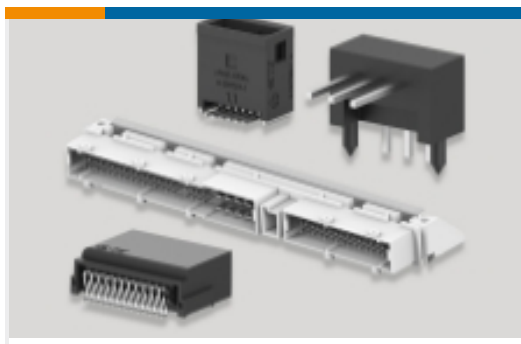

PCB Headers & Receptacles(1)

Also in the Series | **DEUTSCH HD10**



Automotive Connector Caps & Covers (17)



Automotive Housings(53)



Connector Backshells(17)

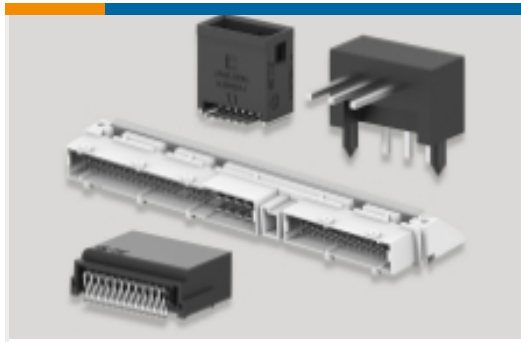

PCB Headers & Receptacles(1)

Customers Also Bought



TE Part #2-2109441-5  
AMP MCP, SEALED CONNECTOR HOUSING



TE Part #HDP24-24-35PE-L017  
REC, 35P, BLK, E, RNG, 16/20, P

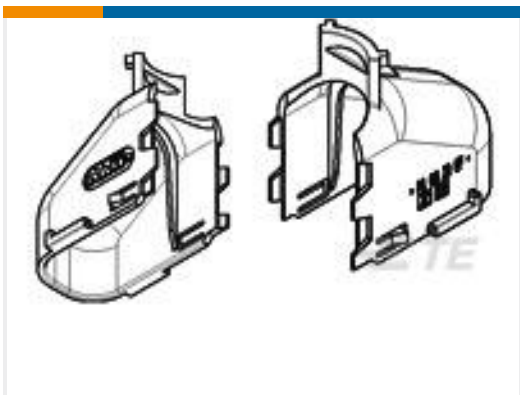

TE Part #953040-1  
VERTIC COVER 31W HYB CONN



TE Part #DTV06-18SB  
PLG, 18P, BLK, N, B



TE Part #1-1456426-6  
4POS, MCON 1.2 CB REC 2p TL SEALED



TE Part #2272975-5  
6 Pos. Sealed MCON 1.2 Connect



TE Part #2289524-1  
4POS, MCON 1.2 CB REC 2p TL UNSEALED



TE Part #DTV06-18SB-C015  
PLG, 18P, BLK, E, B

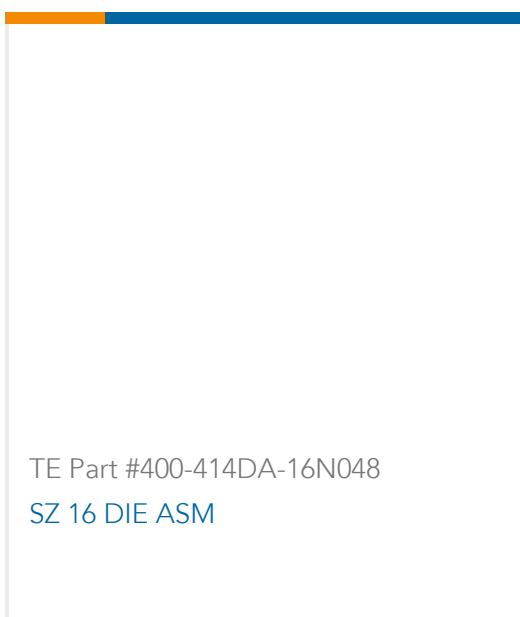

TE Part #400-414DA-16N048  
SZ 16 DIE ASM



## Documents

### Product Drawings

[RECP ASM](#)

English

---

### CAD Files

Customer View Model

[ENG\\_CVM\\_CVM\\_HD10-9-1939PE-P080\\_99.2d\\_dxf.zip](#)

English

[3D PDF](#)

3D

Customer View Model

[ENG\\_CVM\\_CVM\\_HD10-9-1939PE-P080\\_99.3d\\_igs.zip](#)

English

Customer View Model

[ENG\\_CVM\\_CVM\\_HD10-9-1939PE-P080\\_99.3d\\_stp.zip](#)

English

By downloading the CAD file I accept and agree to the [Terms and Conditions](#) of use.

---

### Datasheets & Catalog Pages

[ICT Terminals and Connectors Catalogue](#)

English

[CONNECTOR SELECTOR](#)

English

---

### Product Specifications

[Application Specification](#)

English

---

### Agency Approvals

[UL Report](#)

English