

EEC-325X4A ✓ ACTIVE

DEUTSCH | DEUTSCH DT, DEUTSCH DTM

TE Internal #: EEC-325X4A

Automotive Connector Caps & Covers, Connector Enclosure, Black, PA66 GF15, -67 – 257 °F [-55 – 125 °C], DEUTSCH DTM

[View on TE.com >](#)



Connectors > Automotive Connectors > Automotive Connector Accessories > Automotive Connector Caps & Covers



Protection & Strain Relief Accessory Type: **Connector Enclosure**

Primary Product Color: **Black**

Primary Product Material: **PA66 GF15**

Operating Temperature (Max): **125 °C [257 °F]**

Sealable: **No**

Features

Product Type Features

Protection & Strain Relief Accessory Type	Connector Enclosure
Sealable	No

Body Features

Primary Product Color	Black
Primary Product Material	PA66 GF15

Usage Conditions

Operating Temperature (Max)	125 °C[257 °F]
Operating Temperature Range	-55 – 125 °C[-67 – 257 °F]

Industry Standards

Degree of Protection	IP68, IP6K9K
UL Flammability Rating	UL 94V-0

Packaging Features

Packaging Quantity	1
Packaging Method	Package



Product Compliance

[For compliance documentation, visit the product page on TE.com>](#)

EU RoHS Directive 2011/65/EU	Compliant
EU ELV Directive 2000/53/EC	Compliant
China RoHS 2 Directive MIIT Order No 32, 2016	No Restricted Materials Above Threshold
EU REACH Regulation (EC) No. 1907/2006	Current ECHA Candidate List: JUNE 2023 (235) Candidate List Declared Against: JUNE 2023 (235) Does not contain REACH SVHC
Halogen Content	Not Low Halogen - contains Br or Cl > 900 ppm.
Solder Process Capability	Not reviewed for solder process capability

Product Compliance Disclaimer

This information is provided based on reasonable inquiry of our suppliers and represents our current actual knowledge based on the information they provided. This information is subject to change. The part numbers that TE has identified as EU RoHS compliant have a maximum concentration of 0.1% by weight in homogenous materials for lead, hexavalent chromium, mercury, PBB, PBDE, DBP, BBP, DEHP, DIBP, and 0.01% for cadmium, or qualify for an exemption to these limits as defined in the Annexes of Directive 2011/65/EU (RoHS2). Finished electrical and electronic equipment products will be CE marked as required by Directive 2011/65/EU. Components may not be CE marked. Additionally, the part numbers that TE has identified as EU ELV compliant have a maximum concentration of 0.1% by weight in homogenous materials for lead, hexavalent chromium, and mercury, and 0.01% for cadmium, or qualify for an exemption to these limits as defined in the Annexes of Directive 2000/53/EC (ELV). Regarding the REACH Regulation, the information TE provides on SVHC in articles for this part number is based on the latest European Chemicals Agency (ECHA) 'Guidance on requirements for substances in articles' posted at this URL: <https://echa.europa.eu/guidance-documents/guidance-on-reach>

Compatible Parts

 <p>TE Part # CAT-D485-H342 DEUTSCH DTM Headers</p>	 <p>TE Part # DTM1312PA12PBR008 HDR, 24P, BLK, RA EEC, NI/CU, AB</p>	 <p>TE Part # DTM1312PC12PDR008 HDR, 24P, BLK, RA EEC, NI/CU, CD</p>	 <p>TE Part # DTM13-12PA-R008 HDR, 12P, BLK, RA EEC, NI/CU, A</p>
--	---	---	--



Also in the Series | DEUTSCH DT

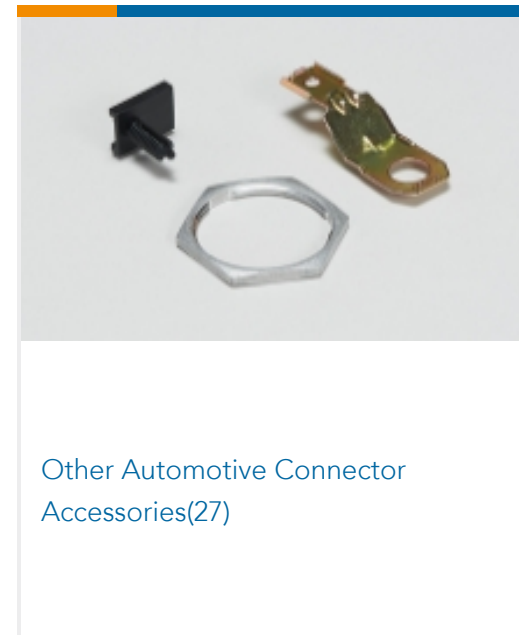
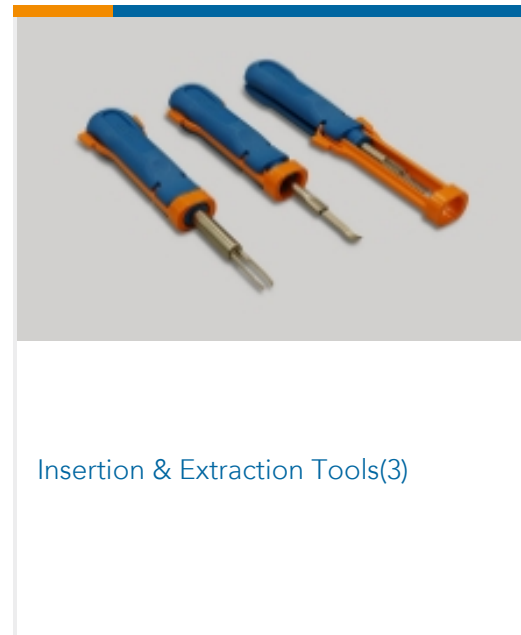
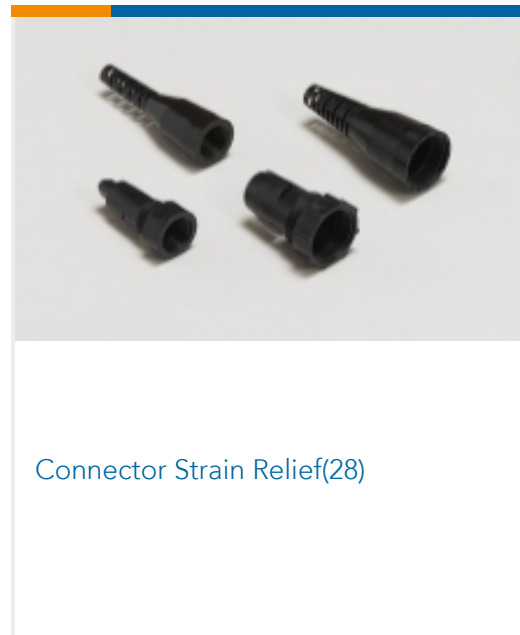
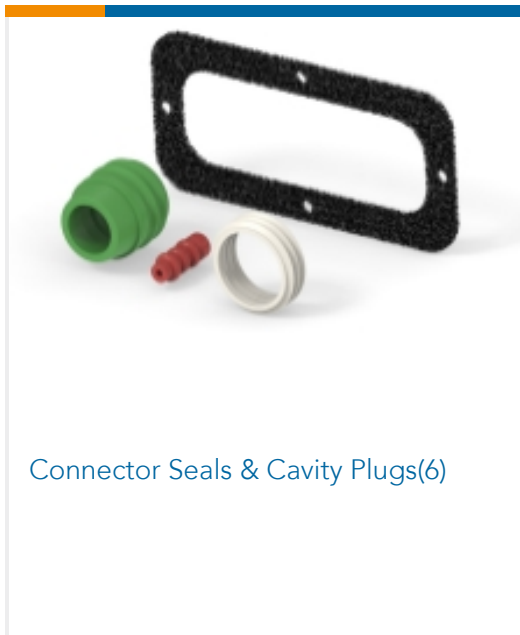
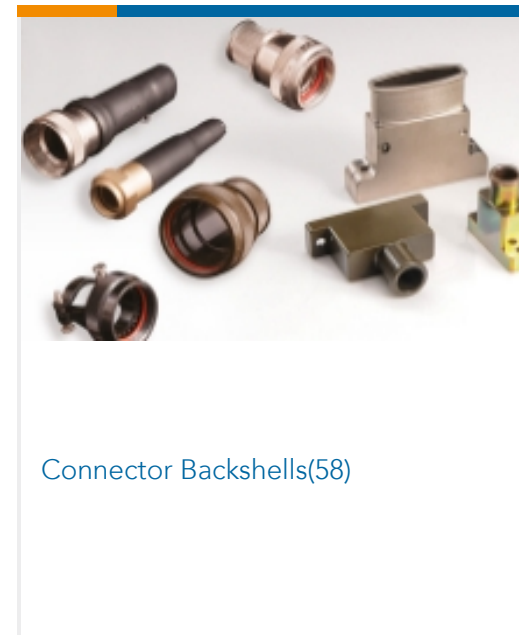
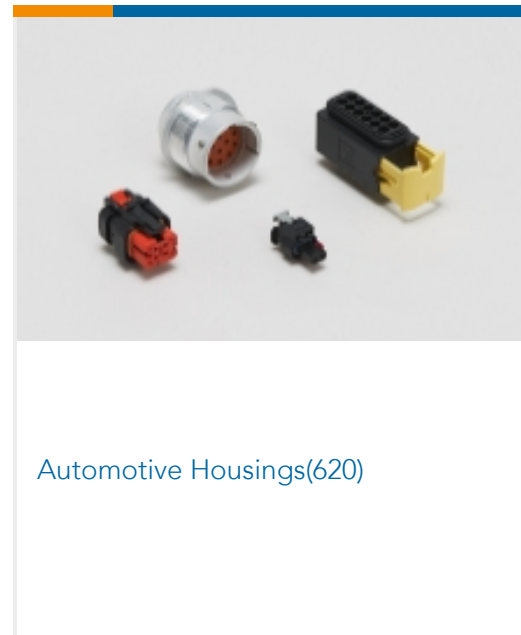
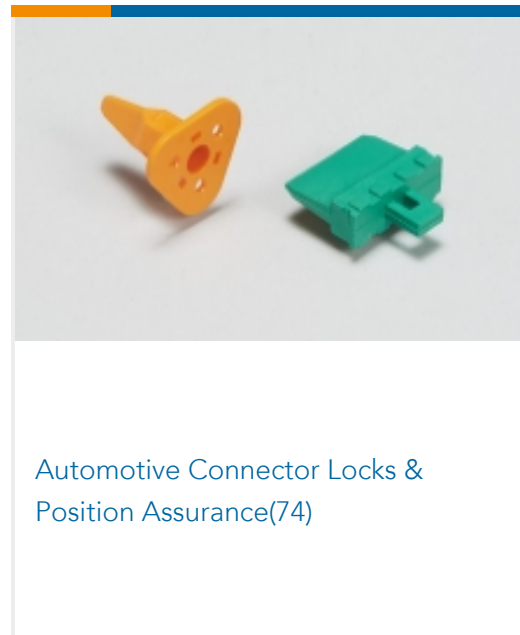
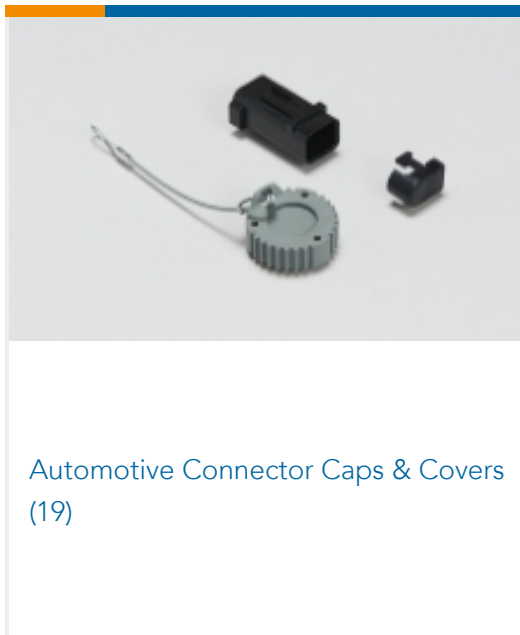

Also in the Series | DEUTSCH DTM



Automotive Connector Caps & Covers (7)



Automotive Connector Locks & Position Assurance(17)



Automotive Housings(100)



Connector Backshells(6)



Connector Strain Relief(28)



Insertion & Extraction Tools(2)

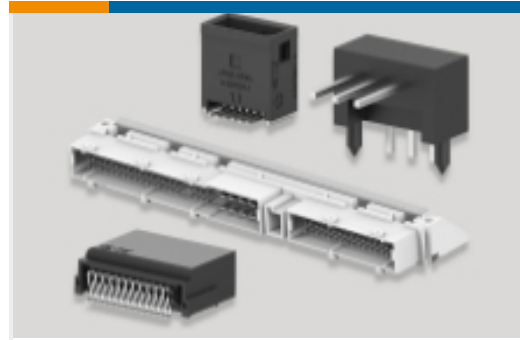

PCB Headers & Receptacles(36)

Customers Also Bought



TE Part #53942-1
TERMINAL,PIDG R 16-14 10



TE Part #1-1630019-7
HSC200 330R 5%



TE Part #EEC-325X4B-E016
ENCLOSURE, 3.25 X 4, CLR, NO VENT



TE Part #2-1879337-9
CPF 0603 4K87 1% 50PPM 1K RL



TE Part #3-2316366-0
AV19 SPM 3A POWER LOGO R&G
12V FL

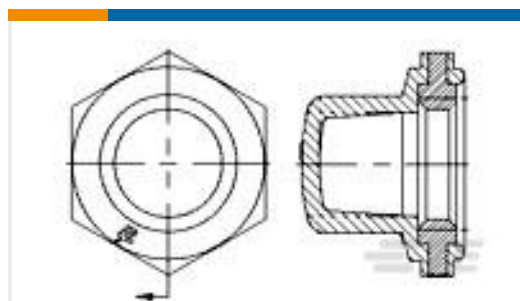

TE Part #1825604-1
BPA1440004=Boot,Pushbutton

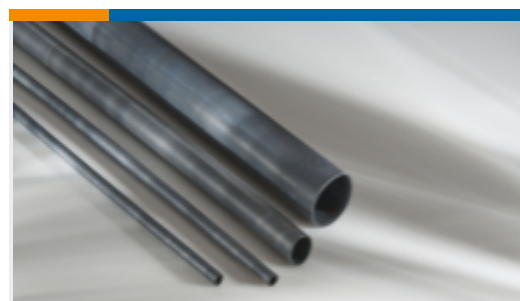

TE Part #EH2301-000
DWFR-52/13-0-STK



TE Part #AS07PT-14-97PN
JAM NUT RECEPT.ASSY HERMETIC
SPECIAL AUT

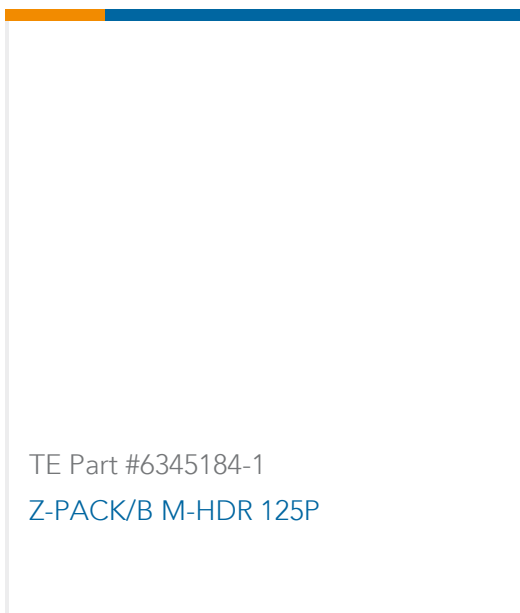

TE Part #6345184-1
Z-PACK/B M-HDR 125P

Documents



Product Drawings

[ENCLOSURE, 3.25 X 4, BLK, VENT](#)

English

CAD Files

[3D PDF](#)

3D

Customer View Model

[ENG_CVM_CVM_EEC-325X4A_G.2d_dxf.zip](#)

English

Customer View Model

[ENG_CVM_CVM_EEC-325X4A_G.3d_igs.zip](#)

English

Customer View Model

[ENG_CVM_CVM_EEC-325X4A_G.3d_stp.zip](#)

English

By downloading the CAD file I accept and agree to the [Terms and Conditions](#) of use.

Datasheets & Catalog Pages

[ICT Terminals and Connectors Catalogue](#)

English

[CONNECTOR SELECTOR](#)

English

Product Specifications

[Product Specification](#)

English

[Product Specification](#)

English