

# DTM15-12PA ✓ ACTIVE

DEUTSCH | DEUTSCH DT, DEUTSCH DTM

TE Internal #: DTM15-12PA

PCB Mount Header, Vertical, Wire-to-Board, 12 Position, 4.19 mm [.165 in] Centerline, Fully Shrouded, Nickel, Through Hole - Solder, Sealable, Hybrid

[View on TE.com >](#)



Connectors > PCB Connectors > PCB Headers & Receptacles > DEUTSCH DTM Headers

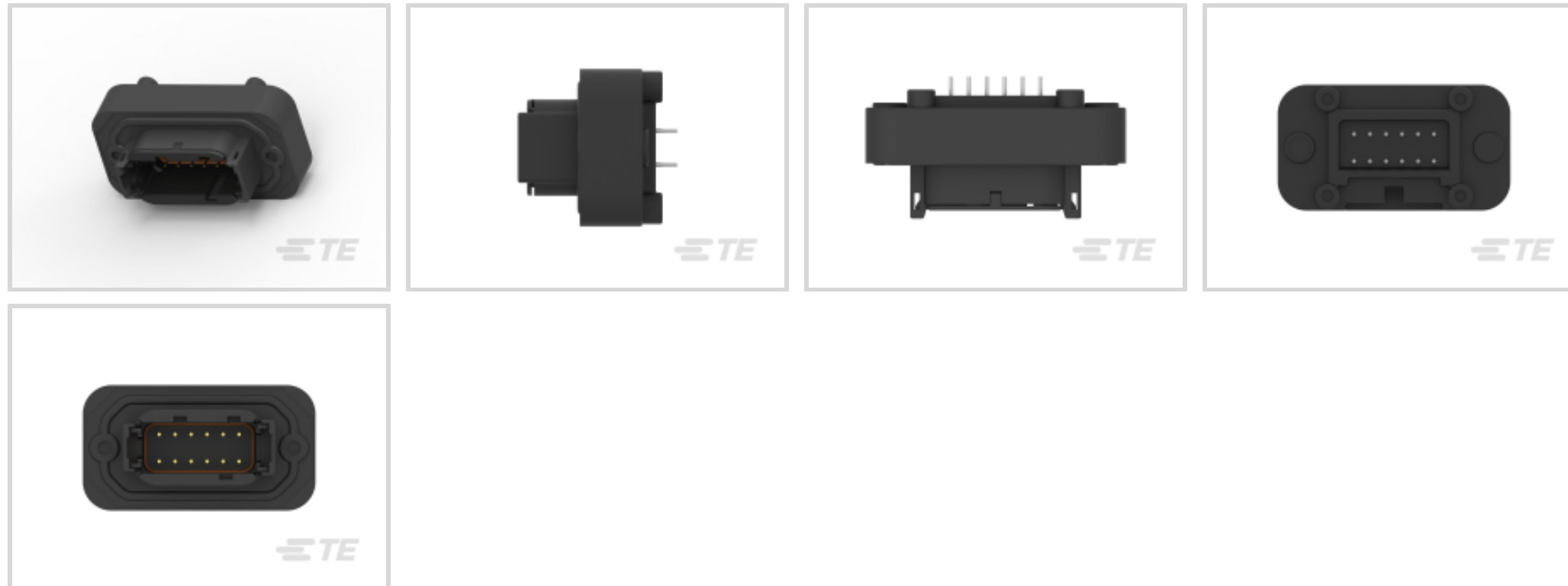

Connector System: **Wire-to-Board**

Number of Positions: **12**

Centerline (Pitch): **4.19 mm [.165 in]**

Sealable: **Yes**

PCB Mount Orientation: **Vertical**

[All DEUTSCH DTM Headers \(32\)](#)

## Features

### Product Type Features

Mixed & Hybrid Header	No
Connector Shape	Rectangular
PCB Connector Assembly Type	PCB Mount Header
Header Type	Fully Shrouded
Connector System	Wire-to-Board
Sealable	Yes
Connector & Contact Terminates To	Wire & Cable

### Configuration Features

Number of Sections	1
Number of Signal Positions	12
Number of Positions	12
PCB Mount Orientation	Vertical
Number of Rows	2



### Electrical Characteristics

Voltage Rating (Max)	250 VAC
Nominal Voltage Architecture	12 V, 24 V
Operating Voltage	250 VAC

### Body Features

Primary Product Color	Gray
Connector & Keying Code	A

### Contact Features

Contact Size	Size 20
Contact Type	Pin
Mating Pin Diameter	1.02 mm[.04 in]
Contact Mating Area Plating Material	Nickel
Contact Current Rating (Max)	7.5 A

### Termination Features

Termination Method to Printed Circuit Board	Through Hole - Solder
---	-----------------------

### Mechanical Attachment

Mounting Holes	With
Mating Alignment Type	Keyed
Mating Retention	With
Mating Alignment	With
PCB Mount Alignment	Without
Panel Mount Feature	With
PCB Mount Retention	With
PCB Mount Retention Type	Mounting Screw
Mating Retention Type	Locking Interface
Connector Mounting Type	Board Mount

### Housing Features

Centerline (Pitch)	4.19 mm[.165 in]
--------------------	------------------

### Dimensions

Connector Length	30.23 mm[1.19 in]
Connector Width	61 mm[2.4 in]
PCB Thickness (Recommended)	.78 – 2.36 mm[.031 – .093 in]



### Usage Conditions

Operating Temperature (Max)	125 °C[257 °F]
Operating Temperature Range	-55 – 125 °C[-67 – 257 °F]

### Operation/Application

Shielded	No
Circuit Application	Signal

### Industry Standards

Degree of Protection	Not Tested
UL Rating	Recognized
UL Flammability Rating	UL 94V-0

### Packaging Features

Packaging Type	Box
Packaging Quantity	125

### Other

Interface Number	DTM04-12P
------------------	-----------

## Product Compliance

[For compliance documentation, visit the product page on TE.com>](#)

EU RoHS Directive 2011/65/EU	Compliant
EU ELV Directive 2000/53/EC	Compliant
China RoHS 2 Directive MIIT Order No 32, 2016	No Restricted Materials Above Threshold
EU REACH Regulation (EC) No. 1907/2006	Current ECHA Candidate List: JUNE 2023 (235) Candidate List Declared Against: JAN 2023 (233) Does not contain REACH SVHC
Halogen Content	Not Low Halogen - contains Br or Cl > 900 ppm.
Solder Process Capability	Not reviewed for solder process capability

#### Product Compliance Disclaimer

This information is provided based on reasonable inquiry of our suppliers and represents our current actual knowledge based on the information they provided. This information is subject to change. The part numbers that TE has identified as EU RoHS compliant have a maximum concentration of 0.1% by weight in homogenous materials for lead, hexavalent chromium, mercury, PBB, PBDE, DBP, BBP, DEHP, DIBP, and 0.01% for cadmium, or qualify for an exemption to these limits as defined in the Annexes of Directive 2011/65/EU (RoHS2). Finished electrical and electronic equipment products will be CE marked as required by Directive 2011/65/EU. Components may not be CE marked. Additionally, the part

numbers that TE has identified as EU ELV compliant have a maximum concentration of 0.1% by weight in homogenous materials for lead, hexavalent chromium, and mercury, and 0.01% for cadmium, or qualify for an exemption to these limits as defined in the Annexes of Directive 2000/53/EC (ELV). Regarding the REACH Regulation, the information TE provides on SVHC in articles for this part number is based on the latest European Chemicals Agency (ECHA) 'Guidance on requirements for substances in articles' posted at this URL: <https://echa.europa.eu/guidance-documents/guidance-on-reach>

## Compatible Parts



## Also in the Series | DEUTSCH DT

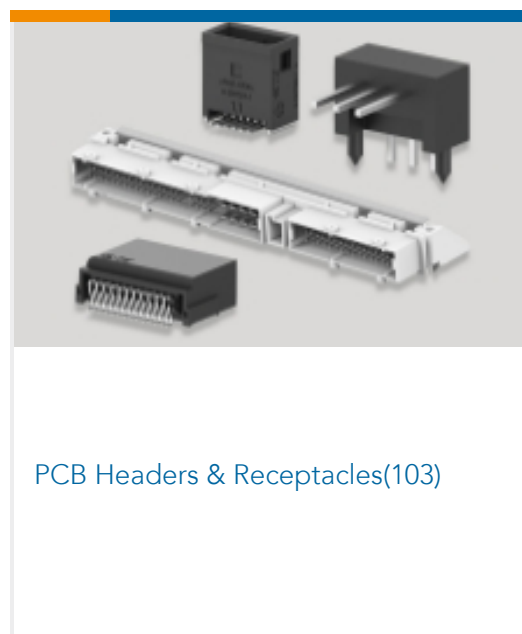
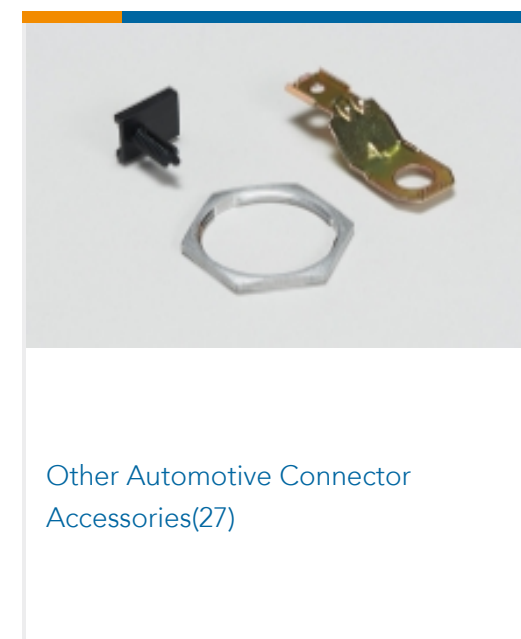
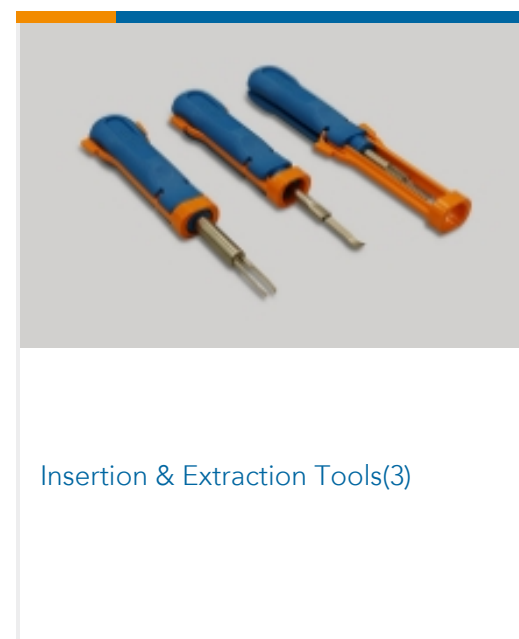
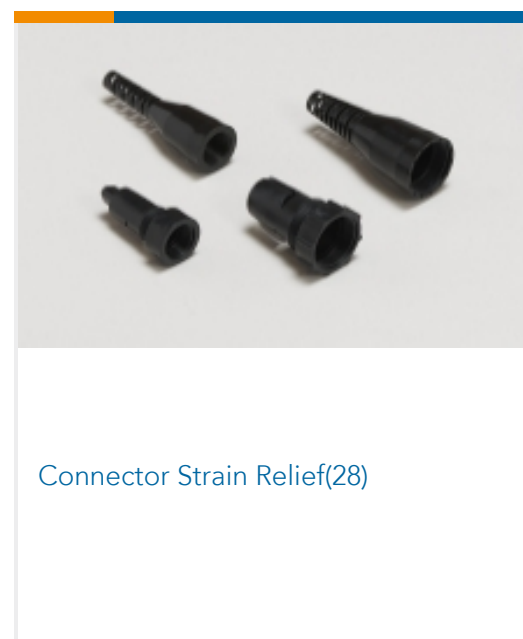
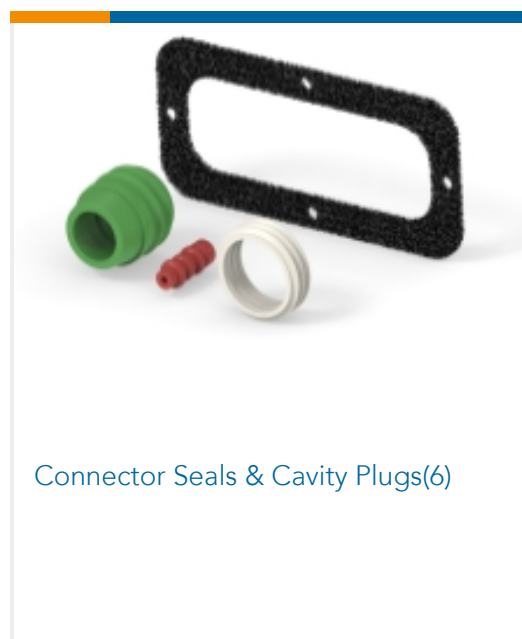
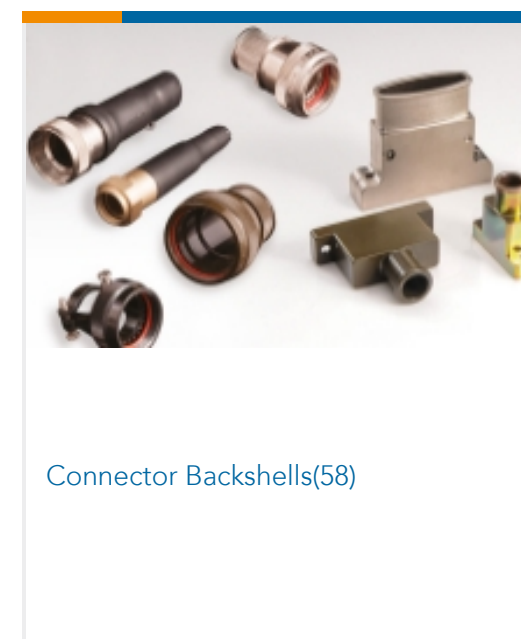
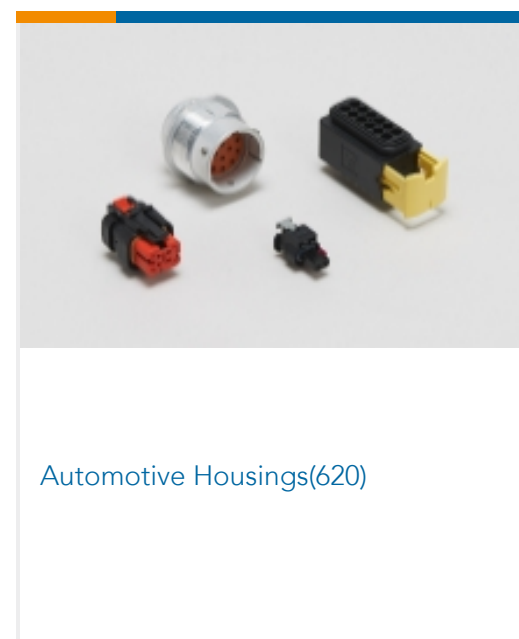
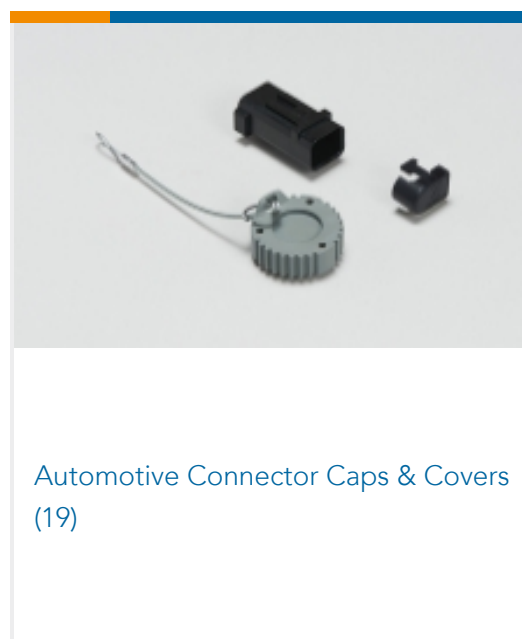

## Also in the Series | DEUTSCH DTM





Automotive Connector Caps & Covers (7)

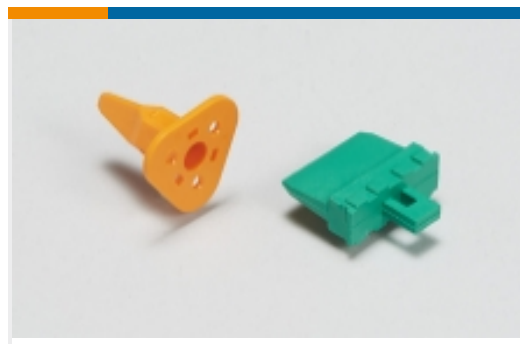

Automotive Connector Locks & Position Assurance(17)

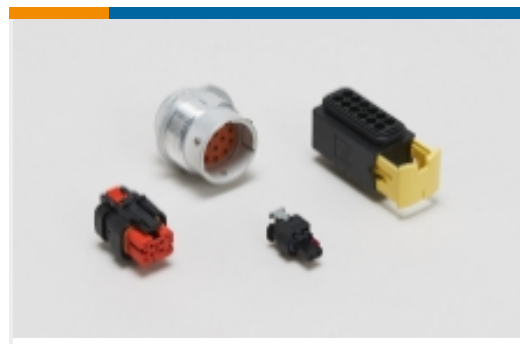

Automotive Housings(100)



Connector Backshells(6)



Connector Strain Relief(28)



Insertion & Extraction Tools(2)

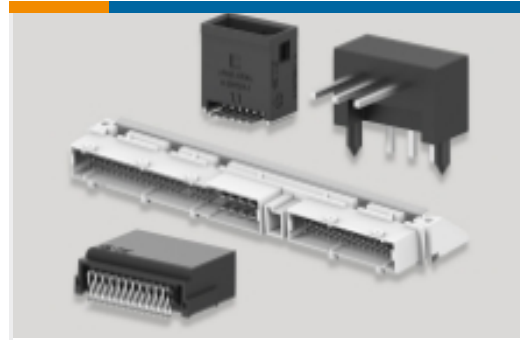

PCB Headers & Receptacles(36)

## Customers Also Bought



TE Part #0460-244-16141  
PIN, SOLID, SIZE 16, EXTENDED PCB, NI

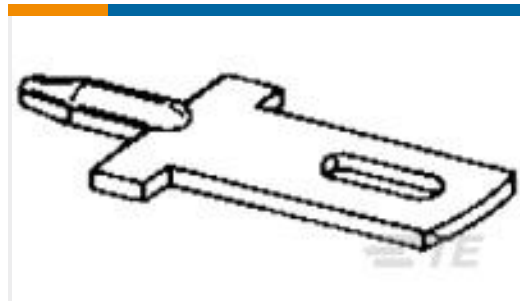

TE Part #735187-2  
110 FASTON TAB TPBR



TE Part #DTM13-12PA  
DEUTSCH DTM Headers



TE Part #DRC23-64PAA  
HDR, 64P, BLK, RA, AU/NI/CU, AA



TE Part #776261-5  
14POS,PIN DIA 1.3,HDR ASSY, 180DEG,COD 5



TE Part #87220-8  
08 MODII HDR SRST UNSHRD .100



TE Part #7-1393222-4  
V23061B1002A501=MINISTARKSTROM

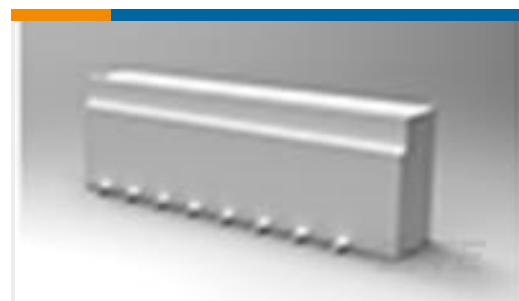

TE Part #1-1735042-4  
1MM FFC SMT V ASSY 14P EMOSS

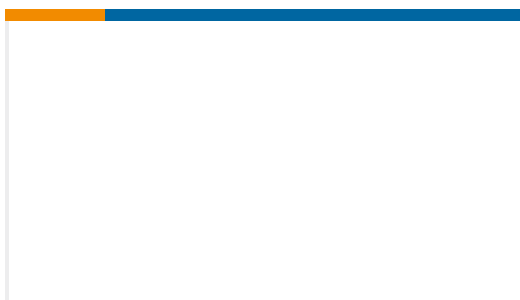

TE Part #1-1825058-6  
ADE07S04=DIP SWTCH,EXT,SMT-GW

## Documents



### Product Drawings

[HDR, 12P, GRY, ST, NI/CU, A](#)

English

---

### CAD Files

Customer View Model

[ENG\\_CVM\\_CVM\\_DTM15-12PA\\_99.2d\\_dxf.zip](#)

English

[3D PDF](#)

3D

Customer View Model

[ENG\\_CVM\\_CVM\\_DTM15-12PA\\_99.3d\\_igs.zip](#)

English

Customer View Model

[ENG\\_CVM\\_CVM\\_DTM15-12PA\\_99.3d\\_stp.zip](#)

English

By downloading the CAD file I accept and agree to the [Terms and Conditions](#) of use.

---

### Datasheets & Catalog Pages

[ICT Terminals and Connectors Catalogue](#)

English

[CONNECTOR SELECTOR](#)

English

---

### Product Specifications

[Application Specification](#)

English

---

### Product Environmental Compliance

[Product Compliance](#)

English

[Product Compliance](#)

English

---

### Agency Approvals

[UL Report](#)

English