

# DTM04-08PA-E003 ✓ ACTIVE

DEUTSCH | DEUTSCH DT, DEUTSCH DTM

TE Internal #: DTM04-08PA-E003

Housing for Male Terminals, Wire-to-Wire, 8 Position, .165 in [4.19 mm] Centerline, Sealable, Gray, Wire & Cable, Power & Signal, Hybrid

[View on TE.com >](#)



Connectors > Automotive Connectors > Automotive Housings > DEUTSCH DTM Housings



Connector System: **Wire-to-Wire**

Number of Positions: **8**

Connector & Housing Type: **Housing for Male Terminals**

Centerline (Pitch): **4.19 mm [ .165 in ]**

Sealable: **Yes**

[All DEUTSCH DTM Housings \(109\)](#)

## Features

### Product Type Features

Mixed & Hybrid Connector	No
Connector Shape	Rectangular
Connector System	Wire-to-Wire
Connector & Housing Type	Housing for Male Terminals
Sealable	Yes
Connector & Contact Terminates To	Wire & Cable
Primary Locking Feature	Integrated in Housing

### Configuration Features

Blank Cavity Position	0
Connector Modification	End Cap
Number of Positions	8
Number of Rows	2

### Electrical Characteristics

Operating Voltage	250 VAC
Nominal Voltage Architecture	12 V, 24 V, 48 V

### Body Features



Cable Exit Angle	180°
Primary Product Color	Gray
Connector & Keying Code	A

### Contact Features

Contact Size	Size 20
Contact Type	Pin
Mating Pin Diameter	1.02 mm[.04 in]
Contact Current Rating (Max)	7.5 A

### Mechanical Attachment

Terminal Position Assurance	Yes
Strain Relief	Add By Accessory
Mating Alignment Type	Keyed
Mating Alignment	With
Connector Mounting Type	Cable Mount (Free-Hanging)

### Housing Features

Housing Material	PA GF
Centerline (Pitch)	4.19 mm[.165 in]

### Dimensions

Connector Height	31.62 mm[1.245 in]
Product Width	20.22 mm[.796 in]
Product Length	45.21 mm[1.78 in]
Row-to-Row Spacing	7.11 mm[.28 in]
Compatible Insulation Diameter Range	1.35 – 3.05 mm[.053 – .12 in]

### Usage Conditions

Operating Temperature (Max)	125 °C[257 °F]
Operating Temperature Range	-55 – 125 °C[-67 – 257 °F]

### Operation/Application

Circuit Application	Power & Signal
---------------------	----------------

### Industry Standards

Degree of Protection	IP68, IP6K9K
Agency/Standard	SAE J2030
UL Flammability Rating	20mm Flame Test per Standard UL-94



### Packaging Features

Packaging Quantity	500
Packaging Method	Box

### Other

Serviceable	Yes
Connector Position Assurance Capable	No

### Product Compliance

For compliance documentation, visit the product page on [TE.com](https://www.te.com)>

EU RoHS Directive 2011/65/EU	Compliant
EU ELV Directive 2000/53/EC	Compliant
China RoHS 2 Directive MIIT Order No 32, 2016	No Restricted Materials Above Threshold
EU REACH Regulation (EC) No. 1907/2006	Current ECHA Candidate List: JUNE 2023 (235) Candidate List Declared Against: JUNE 2023 (235) SVHC > Threshold: Octamethylcyclotetrasiloxane (D4) (.5% in Component Part) Dodecamethylcyclohexasiloxane (D6) (.5% in Component Part) Decamethylcyclopentasiloxane (D5) (.5% in Component Part) <b>Article Safe Usage Statements:</b> Wash thoroughly after handling. Recycle if possible and dispose of the article by following all applicable governmental regulations relevant to your geographic location.
Halogen Content	Not Low Halogen - contains Br or Cl > 900 ppm.
Solder Process Capability	Not reviewed for solder process capability

#### Product Compliance Disclaimer

This information is provided based on reasonable inquiry of our suppliers and represents our current actual knowledge based on the information they provided. This information is subject to change. The part numbers that TE has identified as EU RoHS compliant have a maximum concentration of 0.1% by weight in homogenous materials for lead, hexavalent chromium, mercury, PBB, PBDE, DBP, BBP, DEHP, DIBP, and 0.01% for cadmium, or qualify for an exemption to these limits as defined in the Annexes of Directive 2011/65/EU (RoHS2). Finished electrical and electronic equipment products will be CE marked as required by Directive 2011/65/EU. Components may not be CE marked. Additionally, the part numbers that TE has identified as EU ELV compliant have a maximum concentration of 0.1% by weight in homogenous materials for lead, hexavalent chromium, and mercury, and 0.01% for cadmium, or qualify for an exemption to these limits as defined in the Annexes of Directive 2000/53/EC (ELV). Regarding the REACH Regulation, the information TE provides on SVHC in articles for this part number is based on the latest European Chemicals Agency (ECHA) 'Guidance on requirements for substances in articles' posted at this URL: <https://echa.europa.eu/guidance-documents/guidance-on-reach>



## Compatible Parts



TE Part # CAT-D48-SP729  
DEUTSCH Sealing Plugs



TE Part # CAT-D485-CH8172  
DEUTSCH DTM Housings



TE Part # CAT-D487-M8649  
DEUTSCH DT Mounting Clips



TE Part # CAT-D48-ST273  
DEUTSCH Solid Contacts



TE Part # CAT-D485-W416  
DEUTSCH DTM Wedgelocks



TE Part # 1924487-2  
MOUNTING CLIP, AMPSEAL 16



TE Part # DT-RT1  
EXT TOOL, FRONT RELEASE



TE Part # 1060-20-0622  
PIN, SF, SIZE 20, 14-16, NI/NI



TE Part # 1060-20-0144  
PIN, SF, SIZE 20, 16-22, AU/SN



TE Part # 1060-20-0222  
PIN, SF, SIZE 20, 16-22, NI/NI



TE Part # 1060-20-0122  
PIN, SF, SIZE 20, 16-22, NI/NI



TE Part # 1060-20-0244  
PIN, SF, SIZE 20, 16-22, AU/SN



TE Part # 1060-20-0177  
PIN, SF, SIZE 20, 16-22, SN/SN



TE Part # 1060-20-0277  
PIN, SF, SIZE 20, 16-22, SN/SN



TE Part # CAT-D48-SFT273  
DEUTSCH Stamped and Formed Contacts

## Also in the Series | DEUTSCH DT



Automotive Connector Caps & Covers (19)



Automotive Connector Locks & Position Assurance(74)

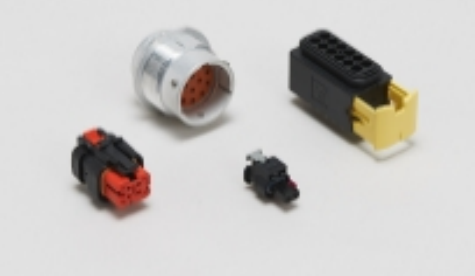

Automotive Housings(620)



Connector Backshells(58)



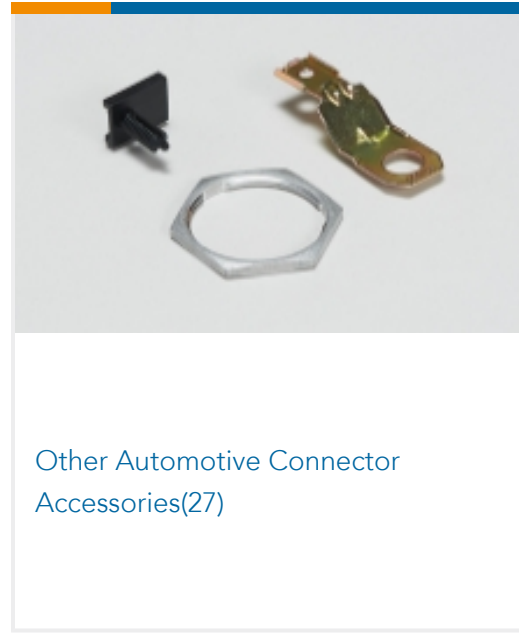
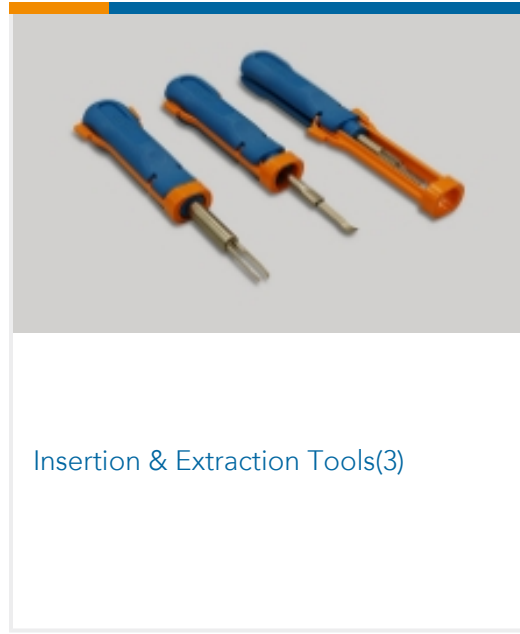
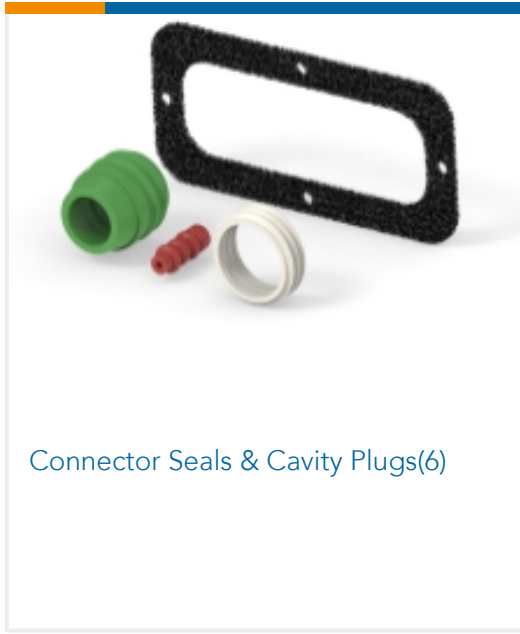

## Also in the Series | DEUTSCH DTM

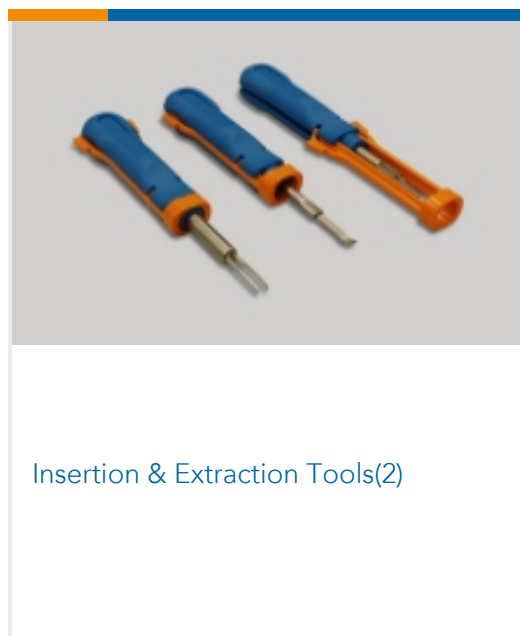
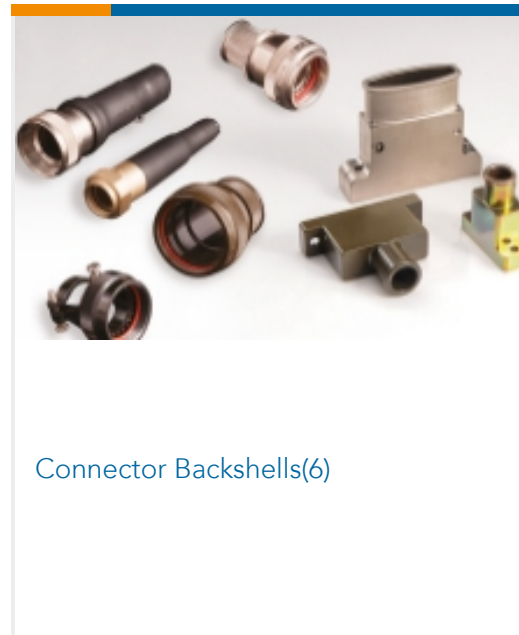
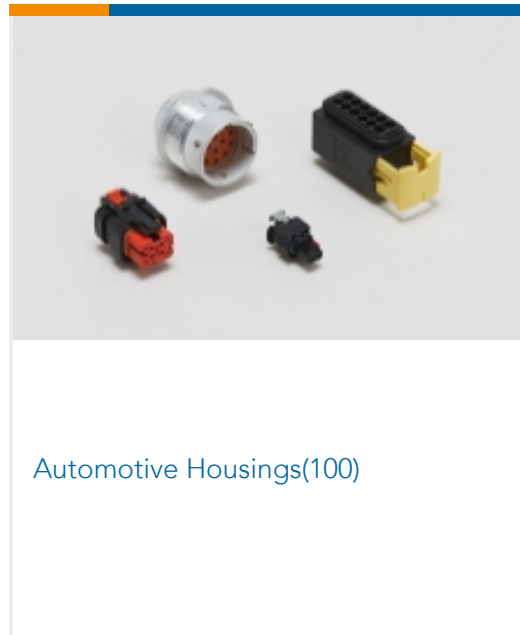
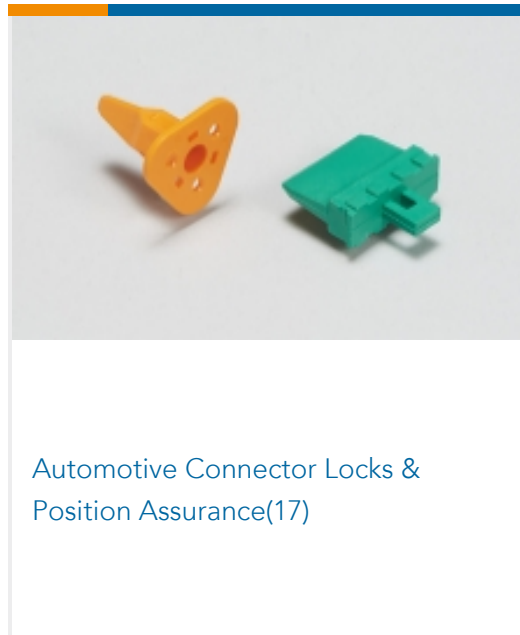
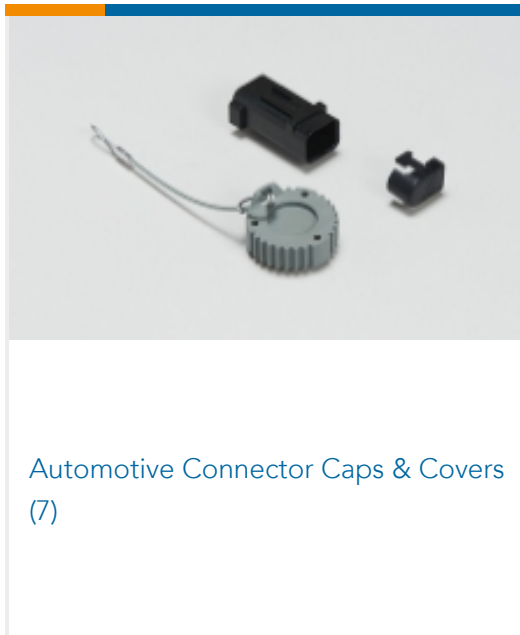

## Customers Also Bought

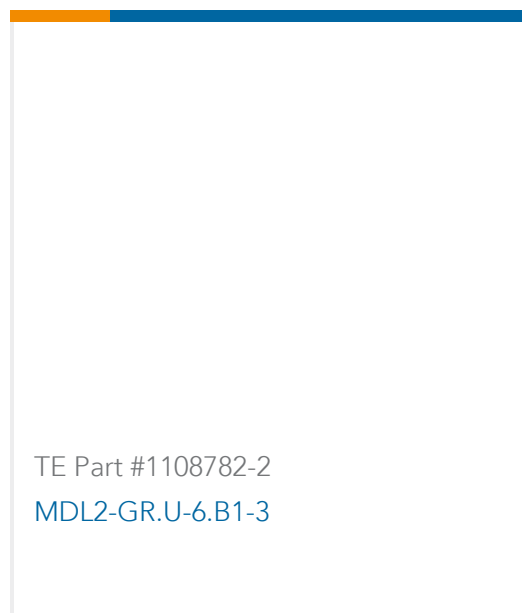
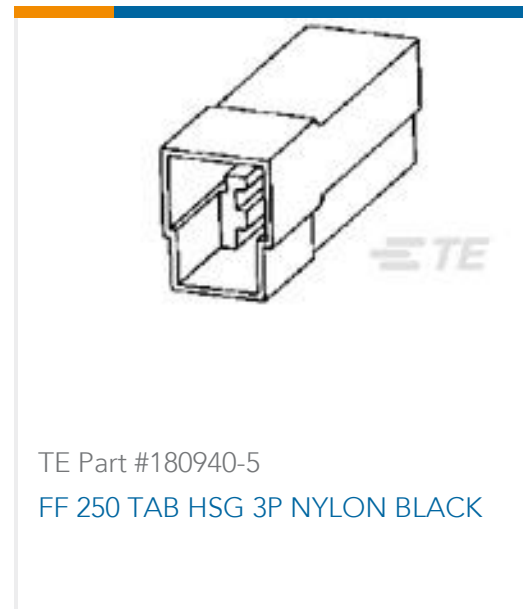

## Documents

### Product Drawings

REC, 8P, GRY, N, CAP, A

English

### CAD Files

3D PDF

3D

Customer View Model

[ENG\\_CVM\\_CVM\\_DTM04-08PA-E003\\_A.2d\\_dxf.zip](#)

English

Customer View Model

[ENG\\_CVM\\_CVM\\_DTM04-08PA-E003\\_A.3d\\_igs.zip](#)

English

Customer View Model

[ENG\\_CVM\\_CVM\\_DTM04-08PA-E003\\_A.3d\\_stp.zip](#)

English

By downloading the CAD file I accept and agree to the [Terms and Conditions](#) of use.

### Datasheets & Catalog Pages



[ICT Terminals and Connectors Catalogue](#)

English

[CONNECTOR SELECTOR](#)

English

---

[Product Specifications](#)

[Engineering Report](#)

English

---

[Agency Approvals](#)

[UL Report](#)

English