

DRC12-40PAE ✓ ACTIVE

DEUTSCH | DEUTSCH DRC

TE Internal #: DRC12-40PAE

Housing for Male Terminals, Wire-to-Wire, 40 Position, .216 in [5.49 mm] Centerline, Sealable, Black, Wire & Cable, Power & Signal, DEUTSCH DRC

[View on TE.com >](#)



Connectors > Automotive Connectors > Automotive Housings > DEUTSCH DRC Housings



Connector System: **Wire-to-Wire**

Number of Positions: **40**

Connector & Housing Type: **Housing for Male Terminals**

Centerline (Pitch): **5.49 mm [.216 in]**

Sealable: **Yes**

[All DEUTSCH DRC Housings \(112\)](#)

Features

Product Type Features

Mixed & Hybrid Connector	No
Connector Shape	Rectangular
Connector System	Wire-to-Wire
Connector & Housing Type	Housing for Male Terminals
Sealable	Yes
Connector & Contact Terminates To	Wire & Cable
Primary Locking Feature	Contact Retainer

Configuration Features

Blank Cavity Position	0
Number of Positions	40
Number of Rows	4

Electrical Characteristics

Operating Voltage	250 VAC
Nominal Voltage Architecture	12 V, 24 V, 48 V

Body Features

Cable Exit Angle	180°
Primary Product Color	Black



Connector & Keying Code	A
-------------------------	---

Contact Features

Contact Size	Size 16
--------------	---------

Contact Type	Pin
--------------	-----

Mating Pin Diameter	1.59 mm[.063 in]
---------------------	------------------

Contact Current Rating (Max)	13 A
------------------------------	------

Mechanical Attachment

Terminal Position Assurance	No
-----------------------------	----

Strain Relief	Add By Accessory
---------------	------------------

Mating Alignment Type	Keyed
-----------------------	-------

Mating Alignment	With
------------------	------

Connector Mounting Type	Panel Mount
-------------------------	-------------

Housing Features

Housing Material	PPS GF
------------------	--------

Centerline (Pitch)	5.49 mm[.216 in]
--------------------	------------------

Dimensions

Connector Height	53.29 mm[2.098 in]
------------------	--------------------

Product Width	97.54 mm[3.84 in]
---------------	-------------------

Product Length	43.15 mm[1.699 in]
----------------	--------------------

Row-to-Row Spacing	5.49 mm[.216 in]
--------------------	------------------

Usage Conditions

Operating Temperature (Max)	125 °C[257 °F]
-----------------------------	----------------

Operating Temperature Range	-55 – 125 °C[-67 – 257 °F]
-----------------------------	----------------------------

Operation/Application

Circuit Application	Power & Signal
---------------------	----------------

Industry Standards

Degree of Protection	IP68, IP6K9K
----------------------	--------------

Agency/Standard	SAE J2030
-----------------	-----------

UL Flammability Rating	20mm Flame Test per Standard UL-94
------------------------	------------------------------------

Packaging Features

Packaging Quantity	60
--------------------	----



Packaging Method Box

Other

Serviceable	Yes
Connector Position Assurance Capable	No

Product Compliance

[For compliance documentation, visit the product page on TE.com>](#)

EU RoHS Directive 2011/65/EU	Compliant
EU ELV Directive 2000/53/EC	Compliant
China RoHS 2 Directive MIIT Order No 32, 2016	No Restricted Materials Above Threshold
EU REACH Regulation (EC) No. 1907/2006	Current ECHA Candidate List: JUNE 2023 (235) Candidate List Declared Against: JUNE 2023 (235) SVHC > Threshold: Octamethylcyclotetrasiloxane (D4) (.4% in Component Part) <small>Article Safe Usage Statements: Wash thoroughly after handling. Recycle if possible and dispose of the article by following all applicable governmental regulations relevant to your geographic location.</small>
Halogen Content	BFR/CFR/PVC Free, but Br/Cl >900 ppm in other sources.
Solder Process Capability	Not reviewed for solder process capability

Product Compliance Disclaimer

This information is provided based on reasonable inquiry of our suppliers and represents our current actual knowledge based on the information they provided. This information is subject to change. The part numbers that TE has identified as EU RoHS compliant have a maximum concentration of 0.1% by weight in homogenous materials for lead, hexavalent chromium, mercury, PBB, PBDE, DBP, BBP, DEHP, DIBP, and 0.01% for cadmium, or qualify for an exemption to these limits as defined in the Annexes of Directive 2011/65/EU (RoHS2). Finished electrical and electronic equipment products will be CE marked as required by Directive 2011/65/EU. Components may not be CE marked. Additionally, the part numbers that TE has identified as EU ELV compliant have a maximum concentration of 0.1% by weight in homogenous materials for lead, hexavalent chromium, and mercury, and 0.01% for cadmium, or qualify for an exemption to these limits as defined in the Annexes of Directive 2000/53/EC (ELV). Regarding the REACH Regulation, the information TE provides on SVHC in articles for this part number is based on the latest European Chemicals Agency (ECHA) 'Guidance on requirements for substances in articles' posted at this URL: <https://echa.europa.eu/guidance-documents/guidance-on-reach>

Compatible Parts



TE Part # CAT-D799-CH8172
DEUTSCH DRC Housings



TE Part # CAT-D48-SP729
DEUTSCH Sealing Plugs



TE Part # CAT-D48-ST273
DEUTSCH Solid Contacts



TE Part # CAT-J67-DSCC16
DEUTSCH Size 16 Crimp Contacts



TE Part # DRC40-GKT
GASKET, 40P, BLK, DRC16



TE Part # DRC40-BT
BOOT, 40P, 16SZ, PLG/REC, ST, BLK



TE Part # DRC40-BT-90DEG
BOOT, 40P, 16SZ, PLG/REC, RA, BLK



TE Part # 2300908-1
0460-003-16329, PIN, SOLID, 20-24AWG, AU



TE Part # 0411-336-1605
EXT TOOL, SIZE 16, 16-20 AWG, E, DRK BLU



TE Part # 0504-001-4001
DUST CAP, 40P, REC, BLK, DRC16



TE Part # 0515-001-4005
PROTECT CVR, 40P, PLG, WHT, DRC16



TE Part # 0515-002-4005
PROTECT CVR, 40P, REC, WHT, DRC16

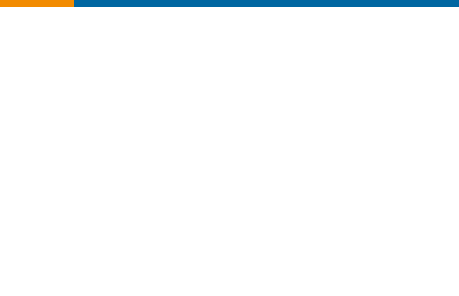

TE Part # CAT-D48-SFT273
DEUTSCH Stamped and Formed Contacts



TE Part # DRC40-BT-DH
BOOT, 40P, 16SZ, PLG/REC, ST, DRN HOLE, BLK



TE Part # DRC40-BT-GRAY
BOOT, 40P, 16SZ, PLG/REC, ST, GRY

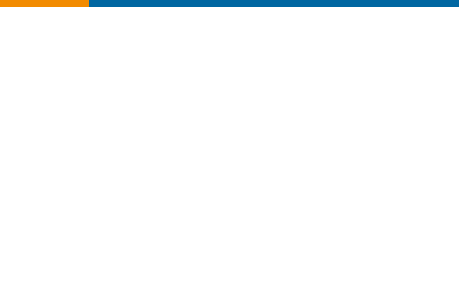

TE Part # DRC40-BT-YW
BOOT, 40P, 16SZ, PLG/REC, ST, YEL

Also in the Series | **DEUTSCH DRC**



Automotive Housings(112)



Connector Backshells(6)



Connector Strain Relief(3)



Insertion & Extraction Tools(7)

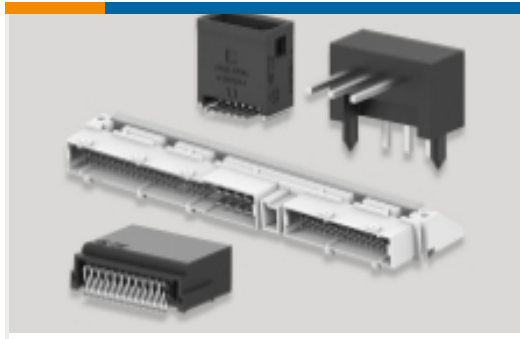

PCB Headers & Receptacles(44)

Customers Also Bought



TE Part #DTHD04-1-4P-E003
REC, 1P, BLK, N, SIZE 4, CAP



TE Part #DRC12-70PBE
DEUTSCH DRC Housings



TE Part #770361-1
06P .093 COMM P&S PLUG .250CL

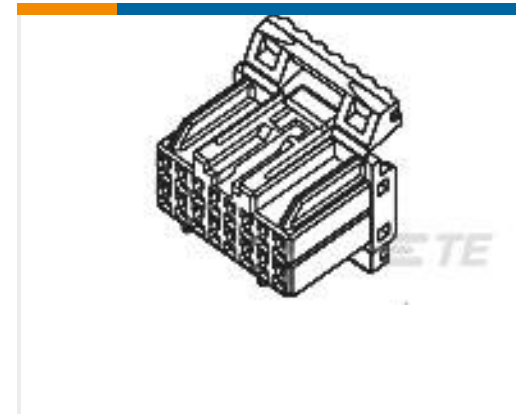

TE Part #174515-7
HYBRID I/O CONN PLUG HSG 22P

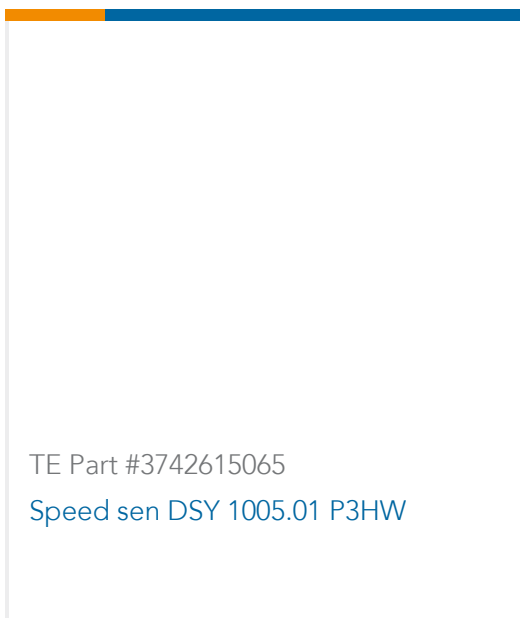

TE Part #3742615065
Speed sen DSY 1005.01 P3HW



TE Part #10208371-00
M71,M713X-012BG-X02988

Documents

Product Drawings

REC, 40P, BLK, E, FLANGE, A

English

CAD Files

Customer View Model

[ENG_CVM_CVM_DRC12-40PAE_99.2d_dxf.zip](#)

English

3D PDF

3D

Customer View Model

[ENG_CVM_CVM_DRC12-40PAE_99.3d_igs.zip](#)

English

Customer View Model

[ENG_CVM_CVM_DRC12-40PAE_99.3d_stp.zip](#)

English

By downloading the CAD file I accept and agree to the [Terms and Conditions](#) of use.



Datasheets & Catalog Pages

[ICT Terminals and Connectors Catalogue](#)

English

Product Specifications

[Application Specification](#)

English

Agency Approvals

[UL Report](#)

English