

AEC14-40PBE-E019 ✓ ACTIVE

DEUTSCH | DEUTSCH DRC

TE Internal #: AEC14-40PBE-E019

Housing for Male Terminals, Wire-to-Wire, 40 Position, .213 in [5.41 mm] Centerline, Sealable, Black, Wire & Cable, Power & Signal, DEUTSCH DRC

[View on TE.com >](#)



Connectors > Automotive Connectors > Automotive Housings > DEUTSCH DRC Housings

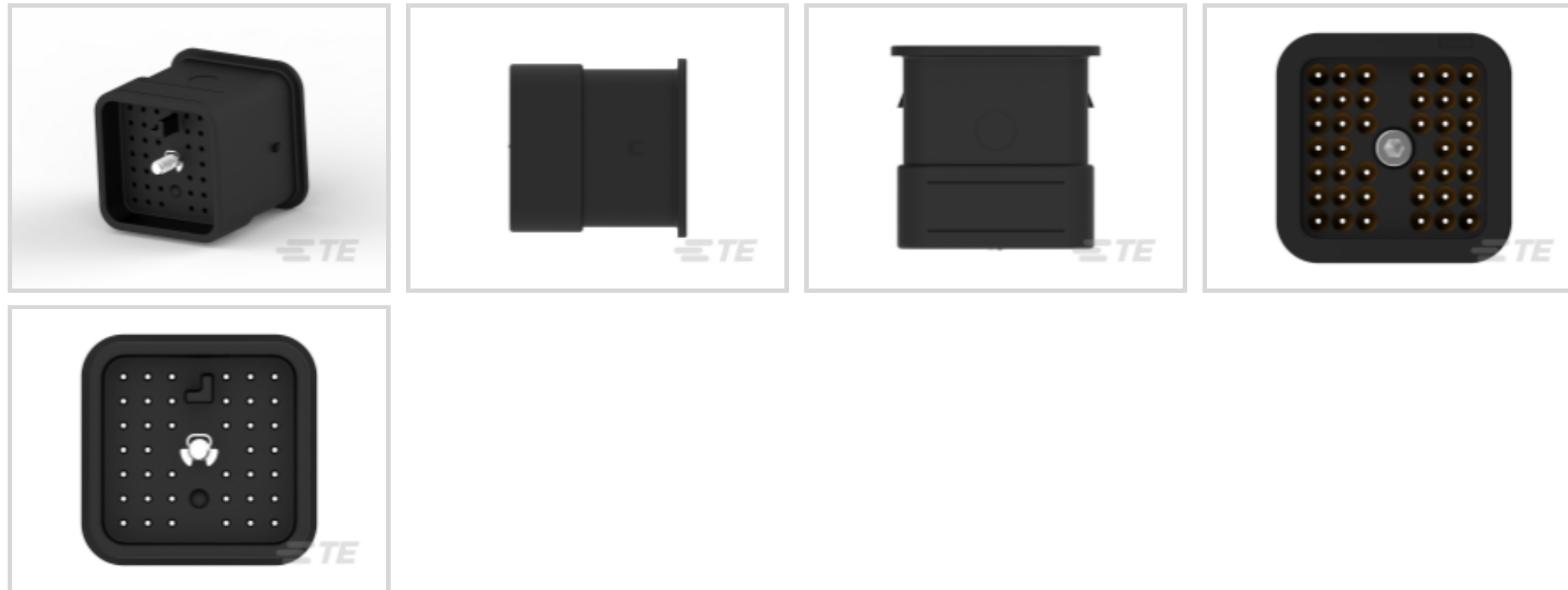

Connector System: **Wire-to-Wire**

Number of Positions: **40**

Connector & Housing Type: **Housing for Male Terminals**

Centerline (Pitch): **5.41 mm [.213 in]**

Sealable: **Yes**

[All DEUTSCH DRC Housings \(112\)](#)

Features

Product Type Features

Mixed & Hybrid Connector	No
Connector Shape	Rectangular
Connector System	Wire-to-Wire
Connector & Housing Type	Housing for Male Terminals
Sealable	Yes
Connector & Contact Terminates To	Wire & Cable
Primary Locking Feature	Integrated in Housing

Configuration Features

Blank Cavity Position	0
Connector Seal Code	E Seal
Number of Positions	40
Number of Rows	7

Electrical Characteristics

Operating Voltage	250 VAC
Nominal Voltage Architecture	12 V, 24 V

Body Features

Cable Exit Angle	180°
Primary Product Color	Black
Connector & Keying Code	B

Contact Features

Contact Size	Size 16
Contact Type	Pin
Mating Pin Diameter	1.59 mm [.063 in]
Contact Current Rating (Max)	13 A

Mechanical Attachment

Terminal Position Assurance	No
Strain Relief	Add By Accessory
Mating Alignment Type	Keyed
Mating Alignment	With
Connector Mounting Type	Cable Mount (Free-Hanging)

Housing Features

Housing Material	PEI (Polyetherimide)
Centerline (Pitch)	5.41 mm [.213 in]

Dimensions

Connector Height	51.26 mm [2.018 in]
Product Width	52.53 mm [2.068 in]
Product Length	50.83 mm [2.001 in]
Row-to-Row Spacing	5.41 mm [.213 in]
Compatible Insulation Diameter Range	1.35 – 3.05 mm [.053 – .12 in]

Usage Conditions

Operating Temperature (Max)	125 °C [257 °F]
Operating Temperature Range	-55 – 125 °C [-67 – 257 °F]

Operation/Application

Circuit Application	Power & Signal
---------------------	----------------



Industry Standards

Degree of Protection	Not Tested
Agency/Standard	SAE J2030
UL Flammability Rating	UL 94HB

Packaging Features

Packaging Quantity	100
Packaging Method	Box

Other

Serviceable	Yes
Connector Position Assurance Capable	No

Product Compliance

[For compliance documentation, visit the product page on TE.com>](#)

EU RoHS Directive 2011/65/EU	Compliant
EU ELV Directive 2000/53/EC	Compliant
China RoHS 2 Directive MIIT Order No 32, 2016	No Restricted Materials Above Threshold
EU REACH Regulation (EC) No. 1907/2006	Current ECHA Candidate List: JUNE 2023 (235) Candidate List Declared Against: JAN 2023 (233) Does not contain REACH SVHC
Halogen Content	Low Halogen - Br, Cl, F, I < 900 ppm per homogenous material. Also BFR/CFR/PVC Free
Solder Process Capability	Not reviewed for solder process capability

Product Compliance Disclaimer

This information is provided based on reasonable inquiry of our suppliers and represents our current actual knowledge based on the information they provided. This information is subject to change. The part numbers that TE has identified as EU RoHS compliant have a maximum concentration of 0.1% by weight in homogenous materials for lead, hexavalent chromium, mercury, PBB, PBDE, DBP, BBP, DEHP, DIBP, and 0.01% for cadmium, or qualify for an exemption to these limits as defined in the Annexes of Directive 2011/65/EU (RoHS2). Finished electrical and electronic equipment products will be CE marked as required by Directive 2011/65/EU. Components may not be CE marked. Additionally, the part numbers that TE has identified as EU ELV compliant have a maximum concentration of 0.1% by weight in homogenous materials for lead, hexavalent chromium, and mercury, and 0.01% for cadmium, or qualify for an exemption to these limits as defined in the Annexes of Directive 2000/53/EC (ELV). Regarding the REACH Regulation, the information TE provides on SVHC in articles for this part number is based on the latest European Chemicals Agency (ECHA) 'Guidance on requirements for substances in articles' posted at this URL: <https://echa.europa.eu/guidance-documents/guidance-on-reach>

Compatible Parts



TE Part # CAT-D48-SP729
DEUTSCH Sealing Plugs



TE Part # CAT-D48-ST273
DEUTSCH Solid Contacts



TE Part # CAT-J67-DSCC16
DEUTSCH Size 16 Crimp Contacts



TE Part # AEC16-40SBE-E019
PLG, 40P, BLK, E, XCAP, B



TE Part # 2300908-1
0460-003-16329, PIN, SOLID, 20-24AWG, AU



TE Part # 0411-336-1605
EXT TOOL, SIZE 16, 16-20 AWG, E, DRK BLU



TE Part # 0504-002-4001
DUST CAP, 40P, REC, BLK, AEC



TE Part # 0515-009-4005
PROTECT CVR, 40P, REC, YEL, AEC

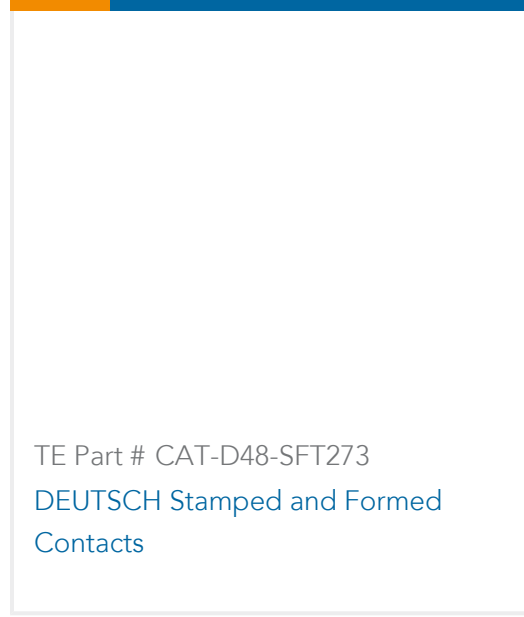

TE Part # CAT-D48-SFT273
DEUTSCH Stamped and Formed Contacts

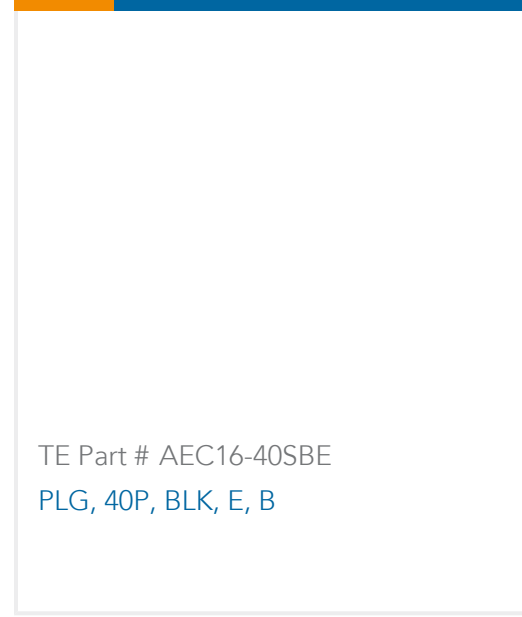

TE Part # AEC16-40SBE
PLG, 40P, BLK, E, B

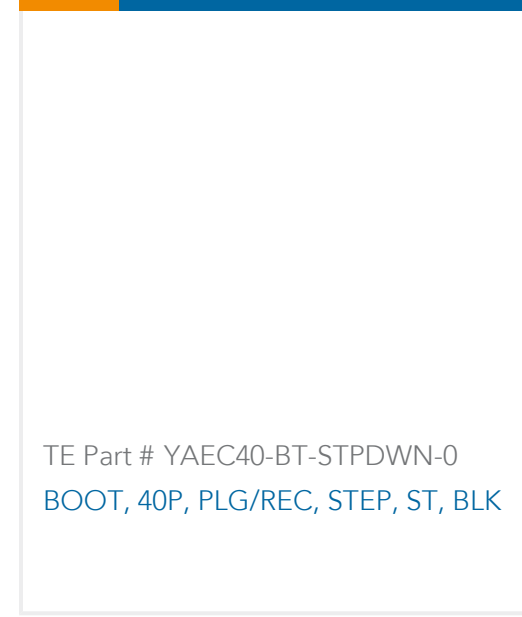

TE Part # YAEC40-BT-STPDWN-0
BOOT, 40P, PLG/REC, STEP, ST, BLK

Also in the Series | **DEUTSCH DRC**



Automotive Housings(112)



Connector Backshells(6)



Connector Strain Relief(3)



Insertion & Extraction Tools(7)



PCB Headers & Receptacles(44)

Customers Also Bought



TE Part #HD10-9-96PE
SQ FG REC ASM



TE Part #776535-2
AS 16, 3P CAP ASSY, RD, KEY 2



TE Part #206306-4
CPC RECPT SEALED SIZE 23-37



TE Part #66253-1
MALE CONTACT ASSY. (STRIP)



TE Part #2822362-4
070 EJ MK-2 SENSOR PLUG 2P DARK GREEN



TE Part #1-2035366-0
Backshell, AS16, 6P, 90Deg, NC12, LP, Plug



TE Part #4-1418448-2
3POS MCP1.5k REC HSG CO MID POS CLOSED



TE Part #2098250-3
PIN, SF, SIZE 16, 16-18 AWG, NI/SN

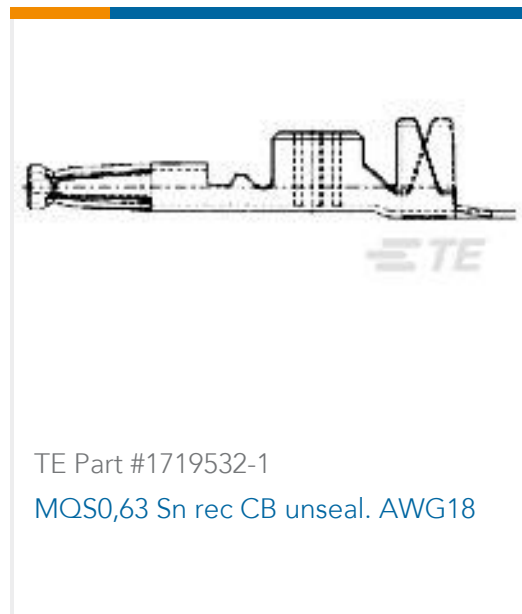

TE Part #1719532-1
MQS0,63 Sn rec CB unseal. AWG18

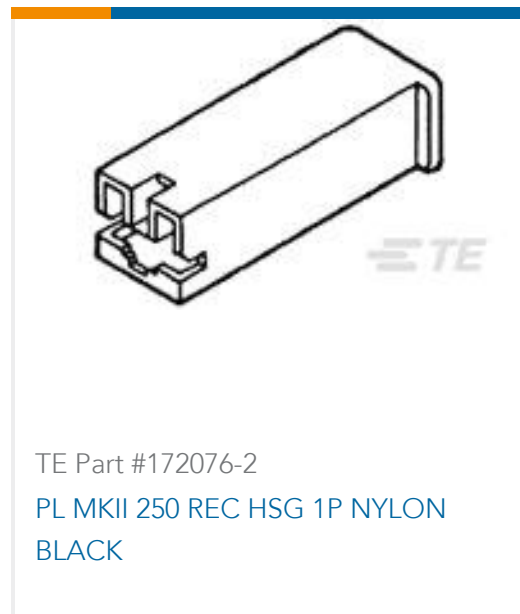

TE Part #172076-2
PL MKII 250 REC HSG 1P NYLON BLACK

Documents

CAD Files

3D PDF

3D

Customer View Model

[ENG_CVM_CVM_AEC14-40PBE-E019_C.2d_dxf.zip](#)

English

Customer View Model

[ENG_CVM_CVM_AEC14-40PBE-E019_C.3d_igs.zip](#)

English

Customer View Model

[ENG_CVM_CVM_AEC14-40PBE-E019_C.3d_stp.zip](#)

English

By downloading the CAD file I accept and agree to the [Terms and Conditions](#) of use.

Datasheets & Catalog Pages

[ICT Terminals and Connectors Catalogue](#)

English

Product Specifications



Product Specification

English

Agency Approvals

UL Report

English