

969484-1 ✓ ACTIVE

RAST | RAST 5 IDC Connectors

TE Internal #: 969484-1

Housing, Receptacle, Wire-to-Board, 2 Position, .196 in [5 mm]
Centerline, Crimp, 1 Row, Natural, Mating Retention, RAST 5 IDC
Connectors

[View on TE.com >](#)



Connectors > PCB Connectors > Wire-to-Board Connectors > Wire-to-Board Connector Assemblies & Housings



Connector Product Type: **Housing**

Connector & Housing Type: **Receptacle**

Connector System: **Wire-to-Board**

Number of Positions: **2**

Centerline (Pitch): **5 mm [.196 in]**

Features

Product Type Features

Connector Product Type	Housing
Connector & Housing Type	Receptacle
Connector System	Wire-to-Board
Sealable	No
Connector & Contact Terminates To	Wire & Cable

Configuration Features

Keying & Polarized Rib Location	1a,1b,2a,2b
Number of Positions	2
Number of Rows	1

Body Features

Primary Product Color	Natural
-----------------------	---------

Contact Features

Contact Layout	Inline
Contact Type	Receptacle



Termination Features

Termination Method to Wire & Cable	Crimp
------------------------------------	-------

Mechanical Attachment

Locking Latch Between Cavity Number	1&2
Strain Relief	Without
Mating Retention Type	Latch
Mating Retention	With
Connector Mounting Type	Cable Mount (Free-Hanging)

Housing Features

Housing Material	PA 6.6
Centerline (Pitch)	5 mm [.196 in]

Dimensions

Connector Length	10 mm [.39 in]
------------------	----------------

Usage Conditions

Operating Temperature Range	-40 – 105 °C [-40 – 221 °F]
-----------------------------	-----------------------------

Operation/Application

Circuit Application	Power & Signal
---------------------	----------------

Industry Standards

RAST Version	None
Glow Wire Rating	Glow Wire
UL Flammability Rating	UL 94V-2

Packaging Features

Packaging Quantity	3200
Packaging Method	Carton

Product Compliance

[For compliance documentation, visit the product page on TE.com>](#)

EU RoHS Directive 2011/65/EU	Compliant
EU ELV Directive 2000/53/EC	Compliant
China RoHS 2 Directive MIIT Order No 32, 2016	No Restricted Materials Above Threshold
EU REACH Regulation (EC) No. 1907/2006	Current ECHA Candidate List: JUNE 2023 (235)



Candidate List Declared Against: JUNE 2023 (235)

Does not contain REACH SVHC

Halogen Content

Low Halogen - Br, Cl, F, I < 900 ppm per homogenous material. Also BFR/CFR/PVC Free

Solder Process Capability

Not applicable for solder process capability

Product Compliance Disclaimer

This information is provided based on reasonable inquiry of our suppliers and represents our current actual knowledge based on the information they provided. This information is subject to change. The part numbers that TE has identified as EU RoHS compliant have a maximum concentration of 0.1% by weight in homogenous materials for lead, hexavalent chromium, mercury, PBB, PBDE, DBP, BBP, DEHP, DIBP, and 0.01% for cadmium, or qualify for an exemption to these limits as defined in the Annexes of Directive 2011/65/EU (RoHS2). Finished electrical and electronic equipment products will be CE marked as required by Directive 2011/65/EU. Components may not be CE marked. Additionally, the part numbers that TE has identified as EU ELV compliant have a maximum concentration of 0.1% by weight in homogenous materials for lead, hexavalent chromium, and mercury, and 0.01% for cadmium, or qualify for an exemption to these limits as defined in the Annexes of Directive 2000/53/EC (ELV). Regarding the REACH Regulation, the information TE provides on SVHC in articles for this part number is based on the latest European Chemicals Agency (ECHA) 'Guidance on requirements for substances in articles' posted at this URL: <https://echa.europa.eu/guidance-documents/guidance-on-reach>

Compatible Parts



TE Part # 5-969484-7
STD TIM MK2 GEH 3P



TE Part # 5-969484-2
STD TIM MK2 GEH 2P



TE Part # 1241961-3
STD TIM HOUSING MKII 2POS



TE Part # 1241961-1
STD TIM HOUSING MKII 2POS



TE Part # 2-969484-2
STD TIM MK2 GEH 2P



TE Part # 1-969484-7
STD TIM MK2 GEH 3P



TE Part # 1955422-1
STD TIM MK2 GEH 2P



TE Part # 2178930-3
3P STD TIMER GEH V0 GWT



Also in the Series | RAST 5 IDC Connectors

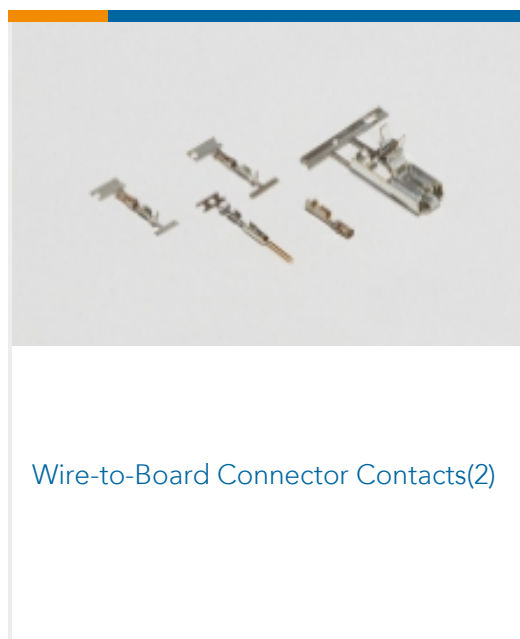
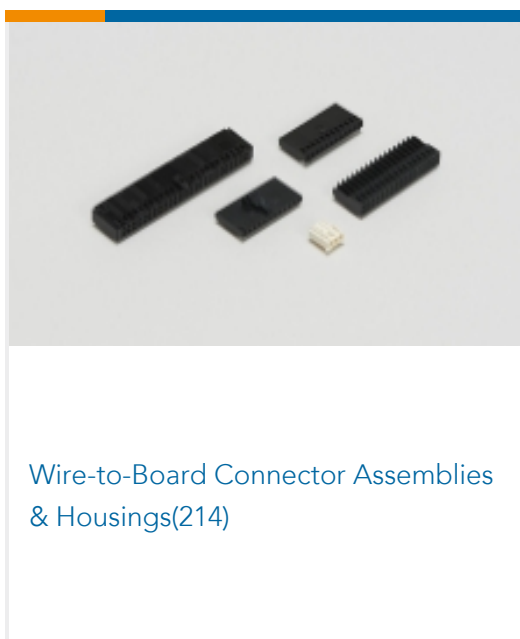
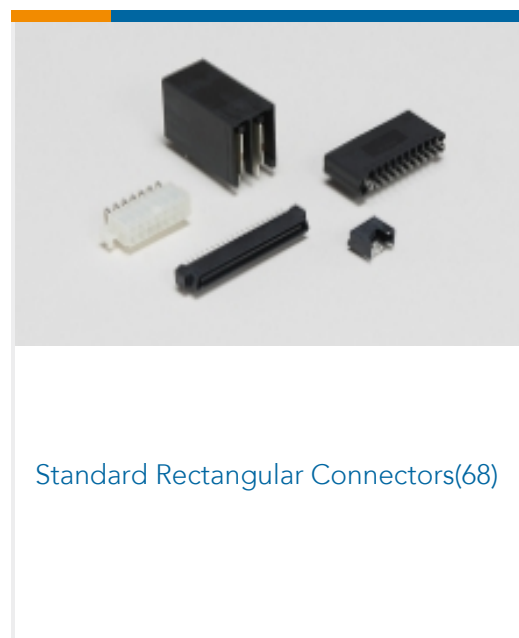
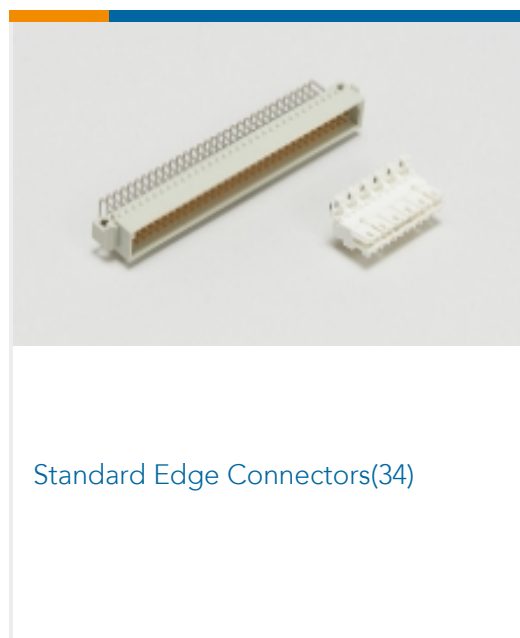
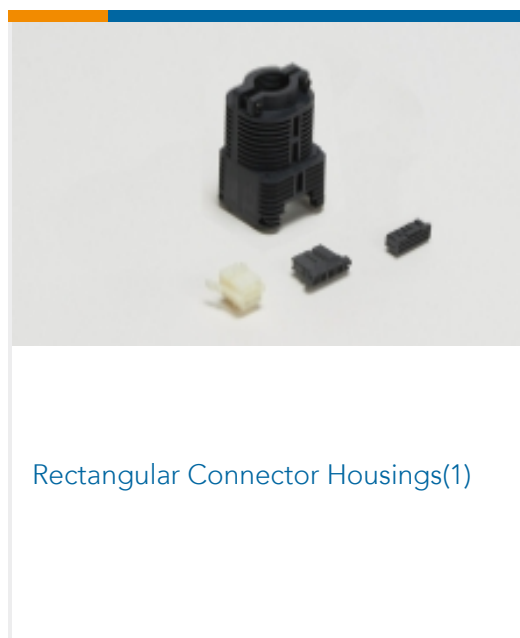
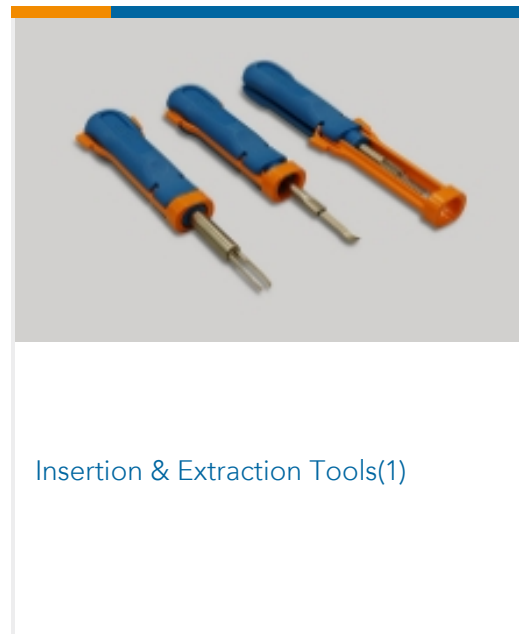
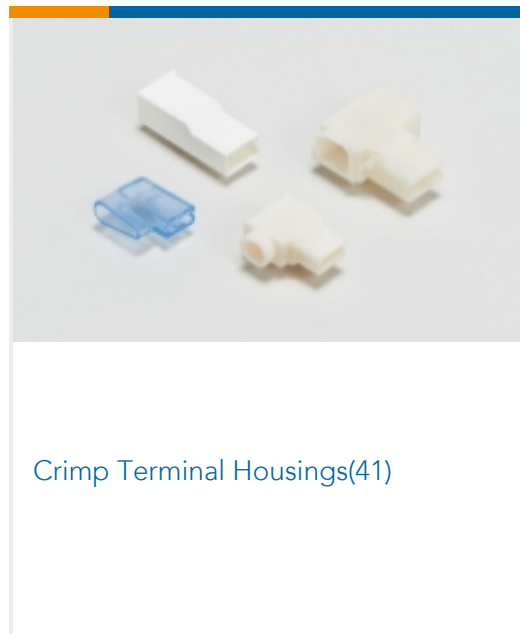
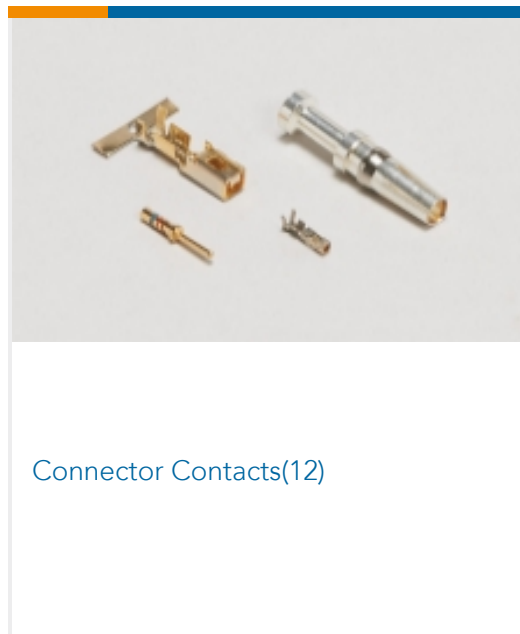
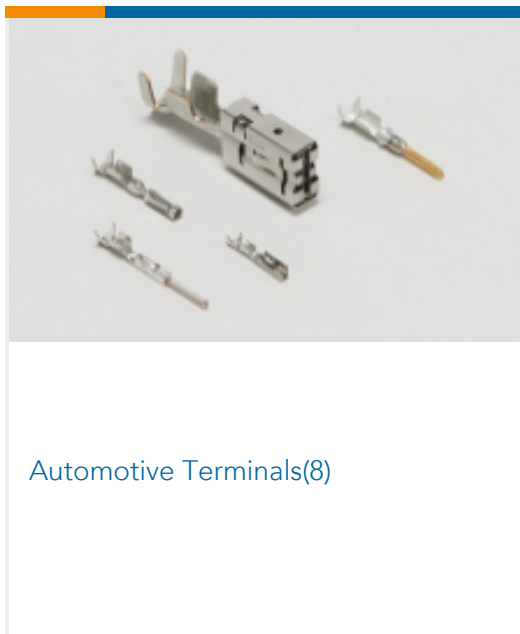

Customers Also Bought

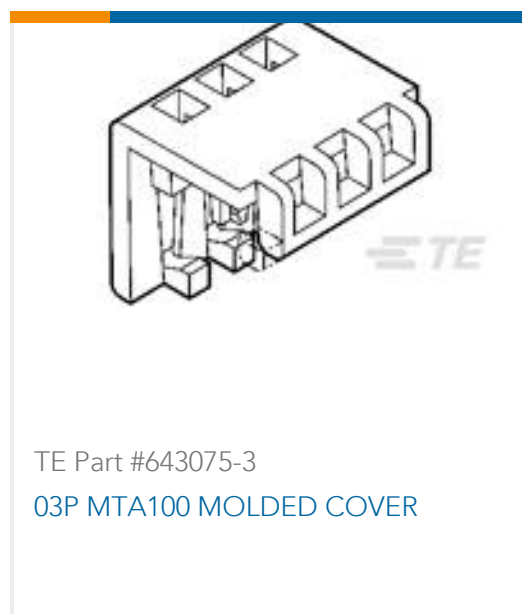

TE Part #643075-3
03P MTA100 MOLDED COVER

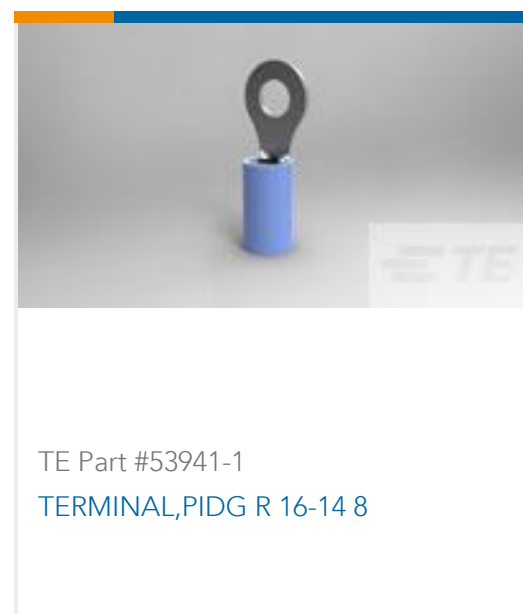

TE Part #53941-1
TERMINAL, PIDG R 16-14 8



TE Part #5-747913-2
25 Rcpt Solder Cup, Gold Flash



TE Part #5-747908-2
15 Plug Solder Cup, Gold Flash



TE Part #2-520129-2
ULTRAFAST 250 ASSY FLAG 22-18
TPBR LP



TE Part #2-520184-2
ULTRAFAST 250 ASSY REC 22-18
TPBR LP



TE Part #172165-1
2 CIR UNIV M-N-L PLUG NATL



TE Part #172168-1
6 CIR UNIV M-N-L PLUG



TE Part #1-794223-0
MINI UMNL2 SCKT 20-16AWG 30AU



TE Part #794222-1
MINI UMNL2 PIN 20-16AWG SN

Documents

Product Drawings

[STD TIM MK2 GEH 2P](#)

English

[STD TIM MK2 GEH 2P](#)

English

CAD Files

[3D PDF](#)

3D

Customer View Model

[ENG_CVM_CVM_969484-1_H_c-969484-1-h.2d_dxf.zip](#)

English

Customer View Model

[ENG_CVM_CVM_969484-1_H_c-969484-1-h.3d_igs.zip](#)

English

Customer View Model

[ENG_CVM_CVM_969484-1_H_c-969484-1-h.3d_stp.zip](#)

English

By downloading the CAD file I accept and agree to the [Terms and Conditions](#) of use.



Product Specifications

Product Specification

German

Product Environmental Compliance

[MD_969484-1_06182014345_dmtec](#)

English

[MD_969484-1_06182014345_dmtec](#)

English