



AMP | Timer Connector System

TE Internal #: 969028-2

Automotive Terminals, Tab, Mating Tab Width 1.6 mm [.063 in], Tab Thickness .6 mm [.024 in], 24 – 20 AWG Wire Size, Timer Connector System

[View on TE.com >](#)

Terminals & Splices > Automotive Terminals > TIMER, RECEPTACLE AND TAB



Terminal Type: **Tab**

Mating Tab Width: **1.6 mm [.063 in]**

Mating Tab Thickness: **.6 mm [.024 in]**

Terminal Transmits: **0 – 24 A (Low Power)**

Wire Size: **24 – 20 AWG**

[All TIMER, RECEPTACLE AND TAB \(348\)](#)

**Features**

**Product Type Features**

Receptacle Style	180°
Sealable	Yes
Primary Locking Feature	Locking Lance

**Body Features**

Terminal Seal Type	Single Wire Seal (SWS)
--------------------	------------------------

**Contact Features**

Contact Size	1.6mm
Contact Fabrication	Stamped & Formed
Wire Contact Termination Area Plating Material	Tin
Typical Current Rating	10 A
Crimp Type	F-Crimp
Terminal Type	Tab
Mating Tab Width	1.6 mm[.063 in]
Mating Tab Thickness	.6 mm[.024 in]
Interface Plating	Tin (Sn)

**Termination Features**

Termination Method to Wire & Cable	Crimp
------------------------------------	-------



Product Terminates To	Wire
-----------------------	------

### Dimensions

Compatible Insulation Diameter Range	1.15 – 1.6 mm [.045 – .063 in]
Wire Size	.2 – .5 mm <sup>2</sup>
Wire Size Search	20 AWG, 21 AWG, 22 AWG, 23 AWG, 24 AWG
Tab Length	22.4 mm [.88 in]

### Usage Conditions

Insulation Option	Uninsulated
Operating Temperature (Max)	130 °C [266 °F]
Operating Temperature Range	-40 – 130 °C [-40 – 266 °F]

### Operation/Application

Compatible With Wire Base Material	Copper
------------------------------------	--------

### Industry Standards

Agency/Standard	DIN 72 551 Part 5 and 6
-----------------	-------------------------

### Packaging Features

Packaging Quantity	4000
Packaging Method	Reel

### Other

Terminal Transmits	0 – 24 A (Low Power)
--------------------	----------------------

### Product Compliance

[For compliance documentation, visit the product page on TE.com>](#)

EU RoHS Directive 2011/65/EU	Compliant
EU ELV Directive 2000/53/EC	Compliant
China RoHS 2 Directive MIIT Order No 32, 2016	No Restricted Materials Above Threshold
EU REACH Regulation (EC) No. 1907/2006	Current ECHA Candidate List: JUNE 2023 (235) Candidate List Declared Against: JUNE 2023 (235) Does not contain REACH SVHC
Halogen Content	Low Halogen - Br, Cl, F, I < 900 ppm per homogenous material. Also BFR/CFR/PVC Free

Solder Process Capability

Not applicable for solder process capability

Product Compliance Disclaimer

This information is provided based on reasonable inquiry of our suppliers and represents our current actual knowledge based on the information they provided. This information is subject to change. The part numbers that TE has identified as EU RoHS compliant have a maximum concentration of 0.1% by weight in homogenous materials for lead, hexavalent chromium, mercury, PBB, PBDE, DBP, BBP, DEHP, DIBP, and 0.01% for cadmium, or qualify for an exemption to these limits as defined in the Annexes of Directive 2011/65/EU (RoHS2). Finished electrical and electronic equipment products will be CE marked as required by Directive 2011/65/EU. Components may not be CE marked. Additionally, the part numbers that TE has identified as EU ELV compliant have a maximum concentration of 0.1% by weight in homogenous materials for lead, hexavalent chromium, and mercury, and 0.01% for cadmium, or qualify for an exemption to these limits as defined in the Annexes of Directive 2000/53/EC (ELV). Regarding the REACH Regulation, the information TE provides on SVHC in articles for this part number is based on the latest European Chemicals Agency (ECHA) 'Guidance on requirements for substances in articles' posted at this URL: <https://echa.europa.eu/guidance-documents/guidance-on-reach>

## Compatible Parts



TE Part # CAT-H3399-CH8172  
Heavy Duty Sealed Connector Series Housings



TE Part # CAT-L489-CH8172  
LEAVYSEAL Housings



TE Part # CAT-AM705-CH8172  
AMP MCP, SEALED CONNECTOR HOUSING



TE Part # 964971-1  
EINZELLEITERDICHTNG



TE Part # 2305570-1  
Strip Terminal Cutter-Side Feed-No Crimp



TE Part # CAT-T4827-CH8172  
Timer Connector Housing

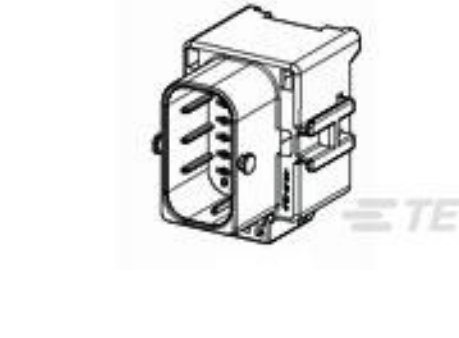

TE Part # 1897686-2  
MCP 1.5 SLD 18P TAB HSG



TE Part # 539960-1  
AUSZ-WKZ,MICRO TIM.



TE Part # 1-1897725-3  
MT-2 SLD 10 CAP HSG GR



TE Part # 1-284844-0  
12 POS MCP HYBRID MALE CONNECTOR



TE Part # 1579008-9  
INSERTION TOOL



TE Part # 2151056-1  
OCEAN\_2.0\_APPLICATION-S-062F1300



TE Part # 2151056-2  
OCEAN\_2.0\_APPLICATION-S-062F130O



TE Part # 2324104-1  
6 POSITIONS E.G.R. WIRE TO WIRE HSG ASSY



TE Part # 4-1718324-1  
1.5/2.8MM TAB HSG.,62POS.,ASSY



TE Part # 5-2151056-1  
OCEAN\_2.0\_APPLICATION-S-062F130O



TE Part # 5-2151056-2  
OCEAN\_2.0\_APPLICATION-S-062F130O



TE Part # 7-2151056-1  
OCEAN\_2.0\_APPLICATION-S-062F130O



TE Part # 7-2151056-2  
OCEAN\_2.0\_APPLICATION-S-062F130O



TE Part # 7-2151056-7  
OCEAN\_2.0\_SPARE\_PART\_KIT-062F130O

## Also in the Series | Timer Connector System



Automotive Connector Caps & Covers (12)

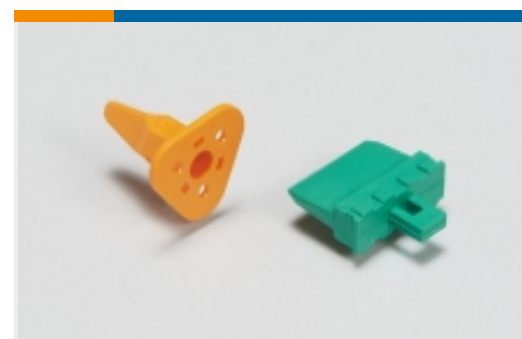

Automotive Connector Locks & Position Assurance(17)



Automotive Housings(233)



Automotive Terminals(145)



Connector Seals & Cavity Plugs(32)



Crimp Terminal Housings(13)



Insertion & Extraction Tools(18)



Other Automotive Connector Accessories(1)



PCB Headers & Receptacles(82)

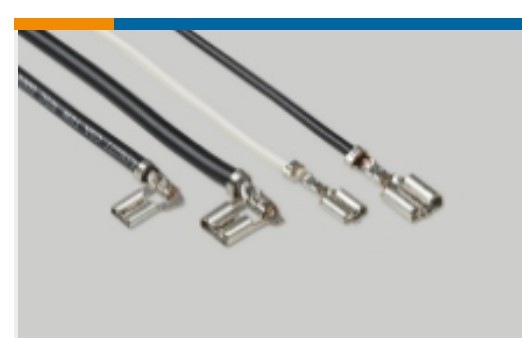

Quick Disconnects(4)

## Customers Also Bought



TE Part #776535-2  
AS 16, 3P CAP ASSY, RD, KEY 2



TE Part #346030-1  
PANEL MT 6W TAB HSG ASSY  
ECONO



TE Part #928966-1  
SPT REC 6.3 Contact SWS Sn



TE Part #2395681-1  
10POS,MQS,REC HSG ASSY,UNSLD,  
COD A

TE Part #2408230-1  
32POS,MQS,REC OUTER HSG,UNSLD

TE Part #2408249-1  
40POS,MPO,REC OUTER HSG,UNSLD

TE Part #2408249-2  
40POS,MQS,REC OUTER HSG,UNSLD

TE Part #2408247-1  
32POS,MQS,REC INNER HSG,UNSLD

TE Part #2408251-1  
40POS,MQS,REC INNER HSG,UNSLD

TE Part #2408230-2  
32POS,MQS,REC OUTER HSG,UNSLD

## Documents

### Product Drawings

[TAB A 1.6x0.6 CONTACT CF SWS Sn](#)

English

[TAB A 1.6x0.6 CONTACT CF SWS Sn](#)

English

### CAD Files

[3D PDF](#)

3D

Customer View Model

[ENG\\_CVM\\_CVM\\_969028-2\\_D.2d\\_dxf.zip](#)

English

Customer View Model

[ENG\\_CVM\\_CVM\\_969028-2\\_D.3d\\_igs.zip](#)

English

Customer View Model

[ENG\\_CVM\\_CVM\\_969028-2\\_D.3d\\_stp.zip](#)

English

By downloading the CAD file I accept and agree to the [Terms and Conditions](#) of use.



---

**Datasheets & Catalog Pages**

**Timer Interconnection System**

English

**HDSCS Catalog**

English

**CONNECTOR SELECTOR**

English

---

**Product Specifications**

**Application Specification**

German

**Application Specification**

English

**Application Specification**

English