

965643-1 ✓ ACTIVE

AMP | Timer Connector System

TE Internal #: 965643-1

Automotive Connector Caps & Covers, Cover, Black, PBT GF,
Timer Connector System

[View on TE.com >](#)



Connectors > Automotive Connectors > Automotive Connector Accessories > Automotive Connector Caps & Covers

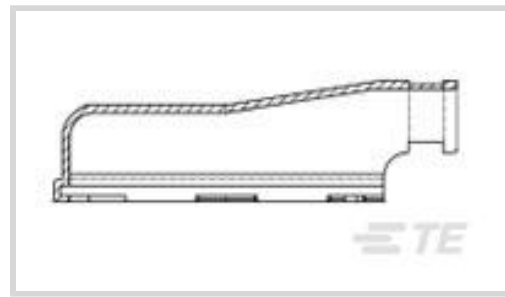

Protection & Strain Relief Accessory Type: **Cover**

Strain Relief: **With**

Primary Product Color: **Black**

Primary Product Material: **PBT GF**

Features

Product Type Features

Protection & Strain Relief Accessory Type	Cover
---	-------

Body Features

Primary Product Color	Black
Primary Product Material	PBT GF

Mechanical Attachment

Strain Relief	With
---------------	------

Dimensions

Compatible Cable Bundle Diameter Range	12.7 mm[.5 in]
--	----------------

Industry Standards

UL Flammability Rating	UL 94HB
------------------------	---------

Packaging Features

Packaging Method	Carton
------------------	--------

Other

Serviceable	Yes
-------------	-----

Product Compliance

[For compliance documentation, visit the product page on TE.com>](#)

EU RoHS Directive 2011/65/EU	Compliant
EU ELV Directive 2000/53/EC	Compliant

China RoHS 2 Directive MIIT Order No 32, 2016	No Restricted Materials Above Threshold
EU REACH Regulation (EC) No. 1907/2006	Current ECHA Candidate List: JUNE 2023 (235) Candidate List Declared Against: JUNE 2023 (235) Does not contain REACH SVHC
Halogen Content	Low Halogen - Br, Cl, F, I < 900 ppm per homogenous material. Also BFR/CFR/PVC Free
Solder Process Capability	Not applicable for solder process capability

Product Compliance Disclaimer

This information is provided based on reasonable inquiry of our suppliers and represents our current actual knowledge based on the information they provided. This information is subject to change. The part numbers that TE has identified as EU RoHS compliant have a maximum concentration of 0.1% by weight in homogenous materials for lead, hexavalent chromium, mercury, PBB, PBDE, DBP, BBP, DEHP, DIBP, and 0.01% for cadmium, or qualify for an exemption to these limits as defined in the Annexes of Directive 2011/65/EU (RoHS2). Finished electrical and electronic equipment products will be CE marked as required by Directive 2011/65/EU. Components may not be CE marked. Additionally, the part numbers that TE has identified as EU ELV compliant have a maximum concentration of 0.1% by weight in homogenous materials for lead, hexavalent chromium, and mercury, and 0.01% for cadmium, or qualify for an exemption to these limits as defined in the Annexes of Directive 2000/53/EC (ELV). Regarding the REACH Regulation, the information TE provides on SVHC in articles for this part number is based on the latest European Chemicals Agency (ECHA) 'Guidance on requirements for substances in articles' posted at this URL: <https://echa.europa.eu/guidance-documents/guidance-on-reach>

Compatible Parts



TE Part # 1-967281-1
MICRO-T2/JPT GEH42P

Also in the Series | Timer Connector System



Automotive Connector Caps & Covers (12)

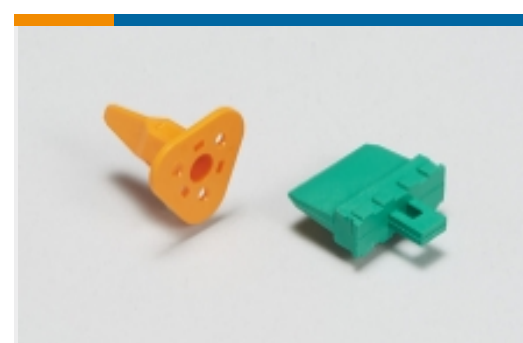

Automotive Connector Locks & Position Assurance(17)



Automotive Housings(233)



Automotive Terminals(145)

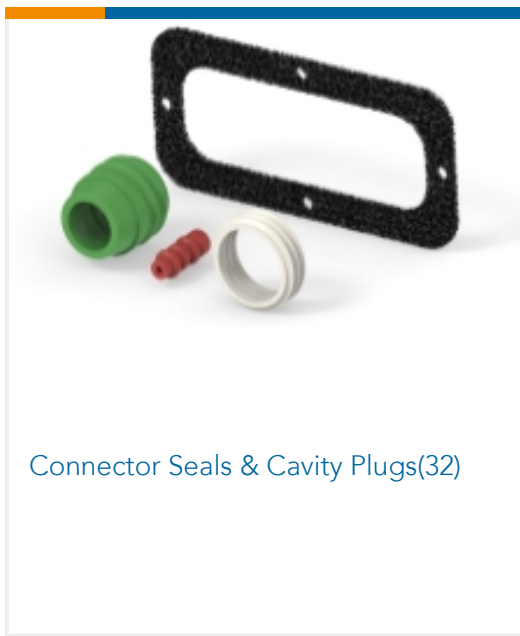

Connector Seals & Cavity Plugs(32)

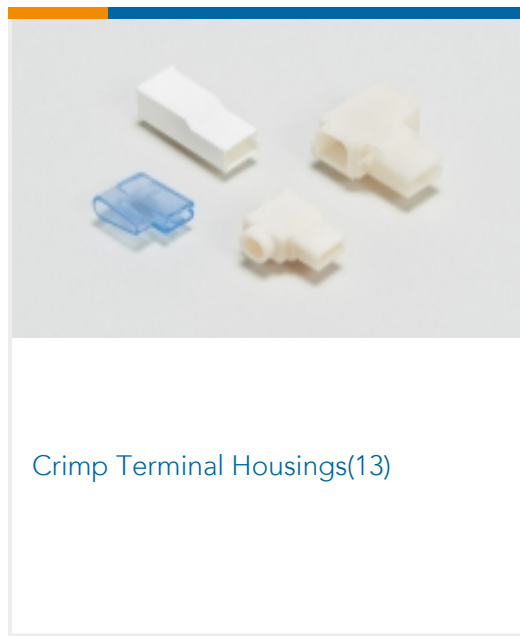

Crimp Terminal Housings(13)

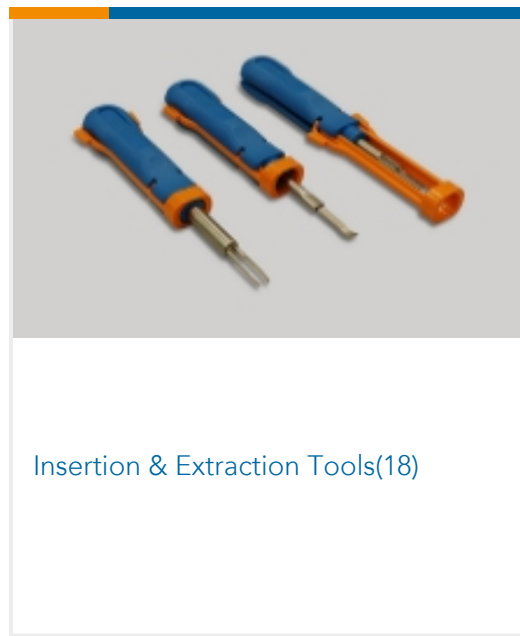

Insertion & Extraction Tools(18)

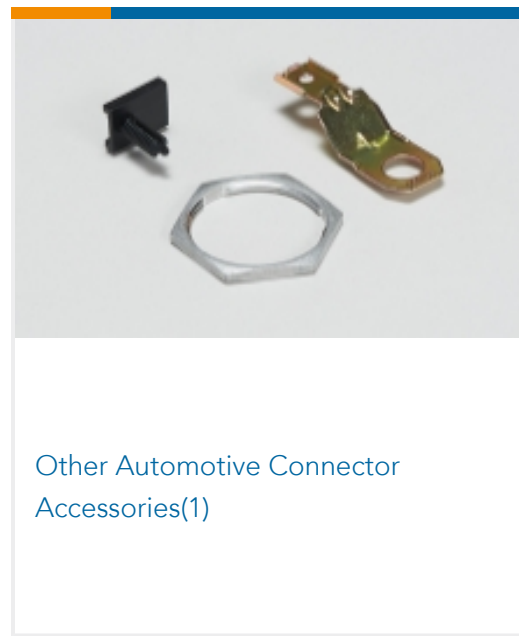

Other Automotive Connector Accessories(1)



PCB Headers & Receptacles(82)

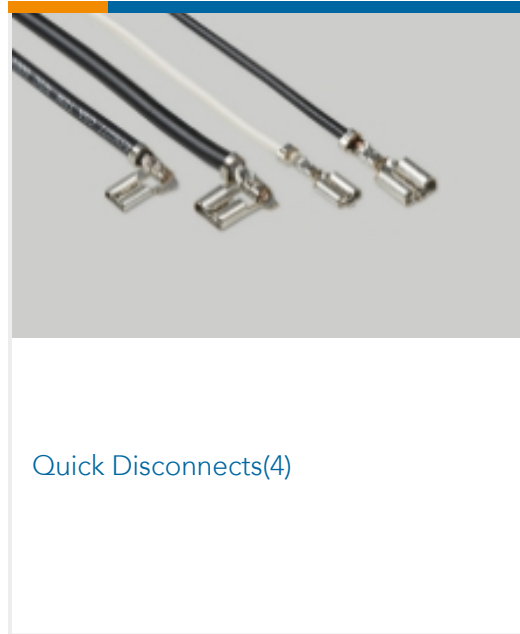

Quick Disconnects(4)

Customers Also Bought



TE Part #1-963226-1
Timer Connector Housing



TE Part #963225-1
DICHTUNG F 42P GEH

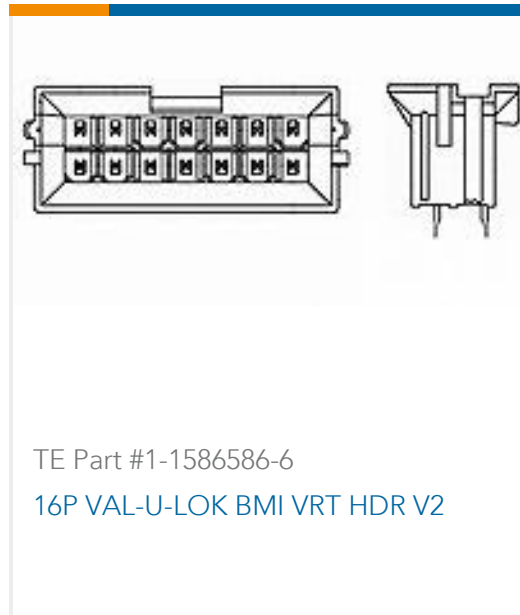

TE Part #1-1586586-6
16P VAL-U-LOK BMI VRT HDR V2



TE Part #1-925370-2
MOD IV REC.HSG 2X12P



TE Part #ANT-MAG-B85-RPS
Antenna Magnetic Base 85mm RG174
4M RPS



TE Part #YHV280-2PM-P-4MM-B
HVA280-2pnm,pass,4sqmm,Key B

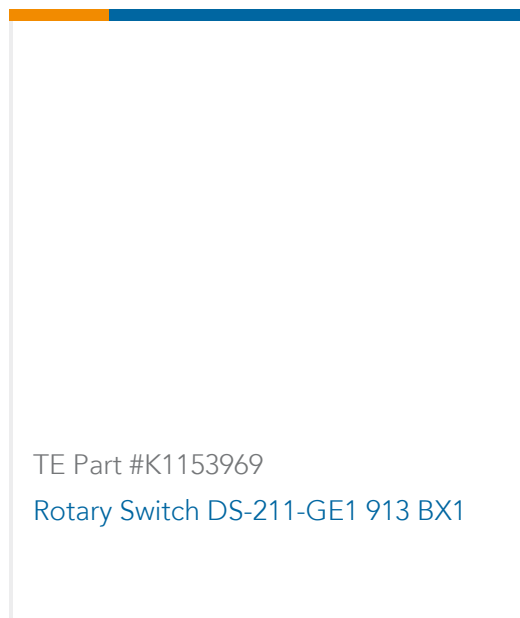

TE Part #K1153969
Rotary Switch DS-211-GE1 913 BX1

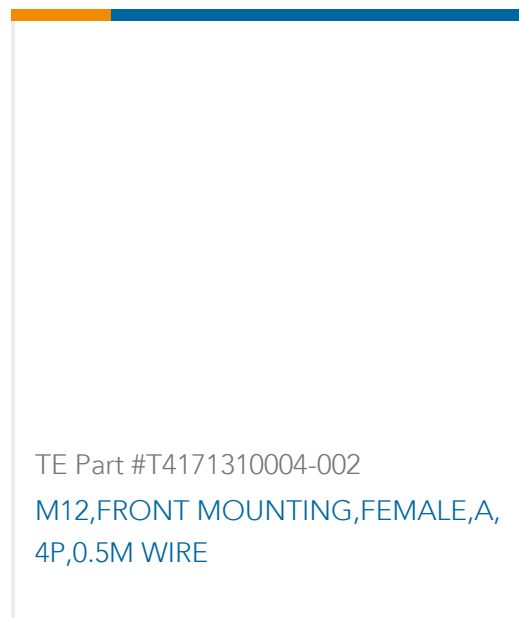

TE Part #T4171310004-002
M12,FRONT MOUNTING,FEMALE,A,
4P,0.5M WIRE

Documents

Product Drawings
[ABDECKKAPPE F42P](#)

English

CAD Files
Customer View Model
[ENG_CVM_CVM_965643-1_A.2d_dxf.zip](#)

English

3D PDF



3D

Customer View Model

[ENG_CVM_CVM_965643-1_A.3d_igs.zip](#)

English

Customer View Model

[ENG_CVM_CVM_965643-1_A.3d_stp.zip](#)

English

By downloading the CAD file I accept and agree to the [Terms and Conditions](#) of use.

Product Environmental Compliance

[MD_965643-1_08162016830_dmtec](#)

English

[MD_965643-1_08162016830_dmtec](#)

English