



AMP | Micro Timer II

TE Internal #: 964274-3

Automotive Terminals, Receptacle, Mating Tab Width 1.6 mm [.063 in], Tab Thickness .6 mm [.024 in], 20 – 17 AWG Wire Size, Micro Timer II

[View on TE.com >](#)

Terminals & Splices > Automotive Terminals > TIMER, RECEPTACLE AND TAB



Terminal Type: **Receptacle**

Mating Tab Width: **1.6 mm [.063 in]**

Mating Tab Thickness: **.6 mm [.024 in]**

Terminal Transmits: **0 – 24 A (Low Power)**

Wire Size: **20 – 17 AWG**

[All TIMER, RECEPTACLE AND TAB \(348\)](#)

Features

Product Type Features

Sealable	Yes
Primary Locking Feature	Locking Lance

Body Features

Terminal Seal Type	Single Wire Seal (SWS)
--------------------	------------------------

Contact Features

Contact Size	1.6mm
Contact Fabrication	Stamped & Formed
Wire Contact Termination Area Plating Material	Tin
Typical Current Rating	10 A
Crimp Type	F-Crimp
Terminal Type	Receptacle
Mating Tab Width	1.6 mm[.063 in]
Mating Tab Thickness	.6 mm[.024 in]
Interface Plating	Gold (Au)

Termination Features

Termination Method to Wire & Cable	Crimp
------------------------------------	-------



Product Terminates To Wire

Dimensions

Compatible Insulation Diameter Range	1.4 – 2.1 mm [.055 – .083 in]
Wire Size	.5 – 1 mm ²
Wire Size Search	17 AWG, 18 AWG, 19 AWG, 20 AWG
Tab Length	19.15 mm [.753 in]

Usage Conditions

Insulation Option	Uninsulated
Operating Temperature (Max)	140 °C [284 °F]
Operating Temperature Range	-40 – 140 °C [-40 – 284 °F]

Operation/Application

Compatible With Wire Base Material	Copper
------------------------------------	--------

Industry Standards

Agency/Standard	IEC 664/664A (DIN VDE 0110)
-----------------	-----------------------------

Packaging Features

Packaging Quantity	4000
Packaging Method	Reel

Other

Terminal Transmits	0 – 24 A (Low Power)
--------------------	----------------------

Product Compliance

[For compliance documentation, visit the product page on TE.com>](#)

EU RoHS Directive 2011/65/EU	Compliant
EU ELV Directive 2000/53/EC	Compliant
China RoHS 2 Directive MIIT Order No 32, 2016	No Restricted Materials Above Threshold
EU REACH Regulation (EC) No. 1907/2006	Current ECHA Candidate List: JUNE 2023 (235) Candidate List Declared Against: JUNE 2023 (235) Does not contain REACH SVHC
Halogen Content	Low Halogen - Br, Cl, F, I < 900 ppm per homogenous material. Also BFR/CFR/PVC Free
Solder Process Capability	Not applicable for solder process capability

Product Compliance Disclaimer

This information is provided based on reasonable inquiry of our suppliers and represents our current actual knowledge based on the information they provided. This information is subject to change. The part numbers that TE has identified as EU RoHS compliant have a maximum concentration of 0.1% by weight in homogenous materials for lead, hexavalent chromium, mercury, PBB, PBDE, DBP, BBP, DEHP, DIBP, and 0.01% for cadmium, or qualify for an exemption to these limits as defined in the Annexes of Directive 2011/65/EU (RoHS2). Finished electrical and electronic equipment products will be CE marked as required by Directive 2011/65/EU. Components may not be CE marked. Additionally, the part numbers that TE has identified as EU ELV compliant have a maximum concentration of 0.1% by weight in homogenous materials for lead, hexavalent chromium, and mercury, and 0.01% for cadmium, or qualify for an exemption to these limits as defined in the Annexes of Directive 2000/53/EC (ELV). Regarding the REACH Regulation, the information TE provides on SVHC in articles for this part number is based on the latest European Chemicals Agency (ECHA) 'Guidance on requirements for substances in articles' posted at this URL: <https://echa.europa.eu/guidance-documents/guidance-on-reach>

Compatible Parts



TE Part # CAT-T4827-CH8172
Timer Connector Housing

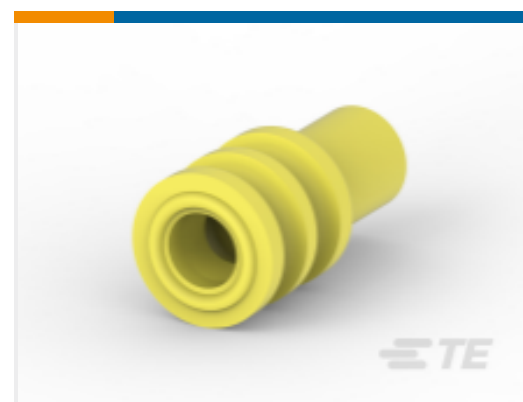

TE Part # 964972-1
EINZELLEITERDICHTNG



TE Part # 963530-1
EINZELLEITERDICHTNG



TE Part # 2305570-1
Strip Terminal Cutter-Side Feed-No Crimp



TE Part # 3-2109313-2
060/110 HYB 8P SLD PLUG ASSY D



TE Part # 5-1579018-6
INSERTION TOOL



TE Part # 539960-1
AUSZ-WKZ,MICRO TIM.



TE Part # 2151057-1
OCEAN_2.0_APPLICATION-S-080F130O



TE Part # 2151057-2
OCEAN_2.0_APPLICATION-S-080F130O



TE Part # 5-2151057-1
OCEAN_2.0_APPLICATION-S-080F130O



TE Part # 5-2151057-2
OCEAN_2.0_APPLICATION-S-080F130O



TE Part # 7-2151057-1
OCEAN_2.0_APPLICATION-S-080F130O



TE Part # 7-2151057-2
OCEAN_2.0_APPLICATOR-S-080F130O



KIT
REPRESENTATION ONLY

TE Part # 7-2151057-7
OCEAN_2.0_SPARE_PART_KIT-080F130O



KIT
REPRESENTATION ONLY

TE Part # 7-2151935-7
OC-080F130O-752_CRIMPTOOLINGKIT



TE Part # 2-2151057-1
OCEAN_2.0_APPLICATOR-S-080F130O



TE Part # 2-2151057-2
OCEAN_2.0_APPLICATOR-S-080F130O

Also in the Series | Micro Timer II



Automotive Connector Caps & Covers (2)



Automotive Connector Locks & Position Assurance(1)



Automotive Housings(34)



Automotive Terminals(30)



Connector Seals & Cavity Plugs(1)



Insertion & Extraction Tools(4)

Customers Also Bought



TE Part #1897009-2
Timer Connector Housing



TE Part #3-1823467-8
6POS,AMP MCP1.5K,REC HSG,CODH



TE Part #936095-1
MULTILOCK, CONNECTOR HOUSING

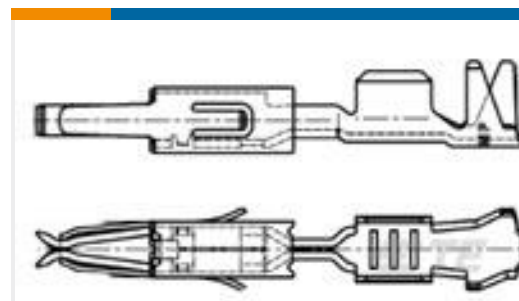

TE Part #964274-2
MT2 A REC 1.6 Contact SWS Sn

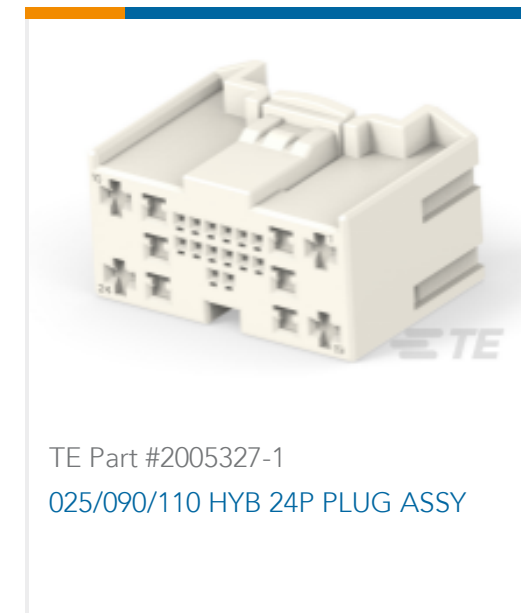

Documents

Product Drawings

MT2 A REC 1.6 Contact SWS Au

English

CAD Files

3D PDF

3D

Customer View Model

[ENG_CVM_CVM_964274-3_E.2d_dxf.zip](#)

English

Customer View Model

[ENG_CVM_CVM_964274-3_E.3d_igs.zip](#)

English

Customer View Model

[ENG_CVM_CVM_964274-3_E.3d_stp.zip](#)

English

By downloading the CAD file I accept and agree to the [Terms and Conditions](#) of use.

Datasheets & Catalog Pages

Timer Interconnection System

English

Product Specifications

Application Specification

German

Application Specification

English

Application Specification

English

[APPLICATION SPECIFICATION FOR: \(Specifica di applicazione per:\) MICRO-TIMER 2 CONTACT WITH RUBBER SEAL](#)

English

Application Specification

English