



Terminals & Splices > Automotive Terminals > TIMER, RECEPTACLE AND TAB



Terminal Type: **Receptacle**

Mating Tab Width: **2.8 mm [.11 in]**

Mating Tab Thickness: **.8 mm [.031 in]**

Terminal Transmits: **25 – 40 A (Power)**

Wire Size: **17 – 13 AWG**

[All TIMER, RECEPTACLE AND TAB \(348\)](#)

Features

Product Type Features

Sealable	Yes
Primary Locking Feature	Locking Lance

Body Features

Terminal Seal Type	Single Wire Seal (SWS)
--------------------	------------------------

Contact Features

Contact Size	2.8mm
Contact Fabrication	Stamped & Formed
Wire Contact Termination Area Plating Material	Tin
Typical Current Rating	30 A
Crimp Type	F-Crimp
Terminal Type	Receptacle
Mating Tab Width	2.8 mm[.11 in]
Mating Tab Thickness	.8 mm[.031 in]
Interface Plating	Tin (Sn)

Termination Features

Termination Method to Wire & Cable	Crimp
------------------------------------	-------



Product Terminates To

Wire

Dimensions

Compatible Insulation Diameter Range

2.2 – 3 mm [.087 – .118 in]

Wire Size

1 – 2.5 mm²

Wire Size Search

13 AWG, 14 AWG, 15 AWG, 16 AWG, 17 AWG

Tab Length

19.55 mm [.769 in]

Usage Conditions

Insulation Option

Uninsulated

Operating Temperature (Max)

130 °C [266 °F]

Operating Temperature Range

-40 – 130 °C [-40 – 266 °F]

Operation/Application

Compatible With Wire Base Material

Copper

Industry Standards

Agency/Standard

IEC 664/664A (DIN VDE 0110)

Packaging Features

Packaging Quantity

3500

Packaging Method

Reel

Other

Terminal Transmits

25 – 40 A (Power)

Product Compliance

[For compliance documentation, visit the product page on TE.com>](#)

EU RoHS Directive 2011/65/EU

Compliant

EU ELV Directive 2000/53/EC

Compliant

China RoHS 2 Directive MIIT Order No 32, 2016

No Restricted Materials Above Threshold

EU REACH Regulation (EC) No. 1907/2006

Current ECHA Candidate List: JUNE 2023 (235)
 Candidate List Declared Against: JUNE 2023 (235)
 Does not contain REACH SVHC

Halogen Content

Low Halogen - Br, Cl, F, I < 900 ppm per homogenous material. Also BFR/CFR/PVC Free

Solder Process Capability

Not applicable for solder process capability

Product Compliance Disclaimer

This information is provided based on reasonable inquiry of our suppliers and represents our current actual knowledge based on the information they provided. This information is subject to change. The part numbers that TE has identified as EU RoHS compliant have a maximum concentration of 0.1% by weight in homogenous materials for lead, hexavalent chromium, mercury, PBB, PBDE, DBP, BBP, DEHP, DIBP, and 0.01% for cadmium, or qualify for an exemption to these limits as defined in the Annexes of Directive 2011/65/EU (RoHS2). Finished electrical and electronic equipment products will be CE marked as required by Directive 2011/65/EU. Components may not be CE marked. Additionally, the part numbers that TE has identified as EU ELV compliant have a maximum concentration of 0.1% by weight in homogenous materials for lead, hexavalent chromium, and mercury, and 0.01% for cadmium, or qualify for an exemption to these limits as defined in the Annexes of Directive 2000/53/EC (ELV). Regarding the REACH Regulation, the information TE provides on SVHC in articles for this part number is based on the latest European Chemicals Agency (ECHA) 'Guidance on requirements for substances in articles' posted at this URL: <https://echa.europa.eu/guidance-documents/guidance-on-reach>

Compatible Parts



TE Part # CAT-M8793-CH8172
MQS, CONNECTOR HOUSING



TE Part # 4-1579007-3
EXTRACTION TOOL KIT



TE Part # 1-1579007-6
EXTRACTION TOOL



TE Part # 963293-1
SEALING F JPT+2,8

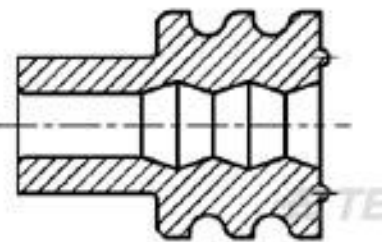

TE Part # 963292-1
WIRE SEALING 2,2



TE Part # 828905-1
SINGLE-WIRE-SEAL(5MM HOLE)



TE Part # 2305570-1
Strip Terminal Cutter-Side Feed-No Crimp



TE Part # CAT-T4827-CH8172
Timer Connector Housing



TE Part # 1473244-3
MQS/JPT 81POS PLUG ASSY



TE Part # 2151063-1
OCEAN_2.0_APPLICATOR-S-100F165O



TE Part # 2151063-2
OCEAN_2.0_APPLICATOR-S-100F165O



TE Part # 2390277-1
SDE F JR PWR TIMER 1.50-2.50mm2 ASSY



TE Part # 2390277-2
SDE F JR PWR TIMER 1.50-2.50mm2
DIE SET



TE Part # 493577-1
ASSY 10 WAY JPT REC



TE Part # 5-2151063-1
OCEAN_2.0_APPLICATOR-S-
100F165O



TE Part # 5-2151063-2
OCEAN_2.0_APPLICATOR-S-
100F165O



TE Part # 7-2151063-1
OCEAN_2.0_APPLICATOR-S-
100F165O



TE Part # 7-2151063-2
OCEAN_2.0_APPLICATOR-S-
100F165O



KIT REPRESENTATION ONLY

TE Part # 7-2151063-7
OCEAN_2.0_SPARE_PART_KIT-
100F165O



KIT REPRESENTATION ONLY

TE Part # 7-2266074-7
OC-100F165O-752-
CRIMP TOOLINGKIT

Also in the Series | Junior Power Timer



Automotive Connector Caps & Covers
(5)



Automotive Housings(252)



Automotive Terminals(86)



Busbars & Terminals(1)



Connector Seals & Cavity Plugs(10)



Insertion & Extraction Tools(8)



Module Components(6)



Other Automotive Connector
Accessories(1)

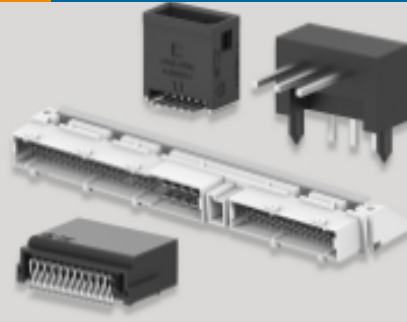

PCB Headers & Receptacles(1)

Customers Also Bought



Documents

Product Drawings

[JPT A REC 2.8 Contact SWS Sn](#)

English

[JPT A REC 2.8 Contact SWS Sn](#)

English

CAD Files

Customer View Model

[ENG_CVM_964273-2_B9.3d_igs.zip](#)

English

Customer View Model

[ENG_CVM_964273-2_B9.3d_stp.zip](#)

English

Customer View Model

[ENG_CVM_964273-2_B9.2d_dxf.zip](#)

English

[3D PDF](#)

English

By downloading the CAD file I accept and agree to the [Terms and Conditions](#) of use.

Datasheets & Catalog Pages

[Timer Interconnection System](#)

English

Product Specifications

[Application Specification](#)

German



[Application Specification](#)

English

[Application Specification](#)

English

[Instruction Sheets](#)

[Instruction Sheet \(non U.S.\)](#)

English

[Instruction Sheet \(non U.S.\)](#)

Japanese