

963730-1 ✓ ACTIVE

AMP | MQS

TE Internal #: 963730-1

Automotive Terminals, Pin, Mating Tab Width .63 mm [.025 in], Tab

Thickness .63 mm [.025 in], 20 – 18 AWG Wire Size, .5 – .75 mm²

Wire Size, MQS

[View on TE.com >](#)



Terminals & Splices > Automotive Terminals

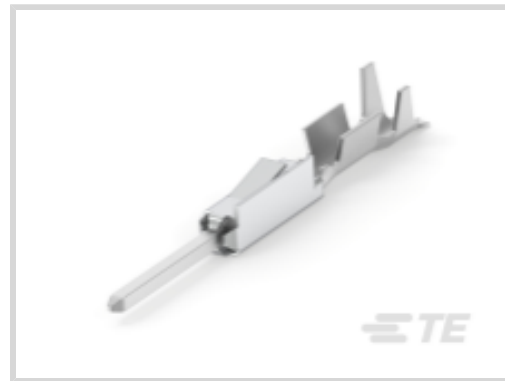

Terminal Type: Pin

Mating Tab Width: .63 mm [.025 in]

Mating Tab Thickness: .63 mm [.025 in]

Wire Size: .5 – .75 mm²

Features

Product Type Features

Sealable	No
Primary Locking Feature	Locking Lance

Contact Features

Contact Size	.63mm
Contact Fabrication	Stamped & Formed
Crimp Type	F-Crimp
Terminal Type	Pin
Mating Tab Width	.63 mm[.025 in]
Mating Tab Thickness	.63 mm[.025 in]
Interface Plating	Tin (Sn)

Termination Features

Termination Method to Wire & Cable	Crimp
Product Terminates To	Wire & Cable

Dimensions

Wire Size	.5 – .75 mm ²
-----------	--------------------------

Usage Conditions

Insulation Option	Uninsulated
Operating Temperature (Max)	120 °C[248 °F]



Operating Temperature Range	-40 – 120 °C[-40 – 248 °F]
-----------------------------	----------------------------

Packaging Features

Packaging Quantity	1000
Packaging Method	Box

Product Compliance

[For compliance documentation, visit the product page on TE.com>](#)

EU RoHS Directive 2011/65/EU	Compliant
EU ELV Directive 2000/53/EC	Compliant
China RoHS 2 Directive MIIT Order No 32, 2016	No Restricted Materials Above Threshold
EU REACH Regulation (EC) No. 1907/2006	Current ECHA Candidate List: JUNE 2023 (235) Candidate List Declared Against: JUNE 2023 (235) Does not contain REACH SVHC
Halogen Content	Low Halogen - Br, Cl, F, I < 900 ppm per homogenous material. Also BFR/CFR/PVC Free
Solder Process Capability	Not applicable for solder process capability

Product Compliance Disclaimer

This information is provided based on reasonable inquiry of our suppliers and represents our current actual knowledge based on the information they provided. This information is subject to change. The part numbers that TE has identified as EU RoHS compliant have a maximum concentration of 0.1% by weight in homogenous materials for lead, hexavalent chromium, mercury, PBB, PBDE, DBP, BBP, DEHP, DIBP, and 0.01% for cadmium, or qualify for an exemption to these limits as defined in the Annexes of Directive 2011/65/EU (RoHS2). Finished electrical and electronic equipment products will be CE marked as required by Directive 2011/65/EU. Components may not be CE marked. Additionally, the part numbers that TE has identified as EU ELV compliant have a maximum concentration of 0.1% by weight in homogenous materials for lead, hexavalent chromium, and mercury, and 0.01% for cadmium, or qualify for an exemption to these limits as defined in the Annexes of Directive 2000/53/EC (ELV). Regarding the REACH Regulation, the information TE provides on SVHC in articles for this part number is based on the latest European Chemicals Agency (ECHA) 'Guidance on requirements for substances in articles' posted at this URL: <https://echa.europa.eu/guidance-documents/guidance-on-reach>

Compatible Parts



TE Part # 1452426-1
EXTRACTION TOOL



TE Part # 6-1579007-1
EXTRACTION TOOL



TE Part # 5-963716-1
MQS0,63 Sn tab LL unseal. 0,5-0,75



TE Part # CAT-M8793-CH8172
MQS, CONNECTOR HOUSING



Also in the Series | **MQS**

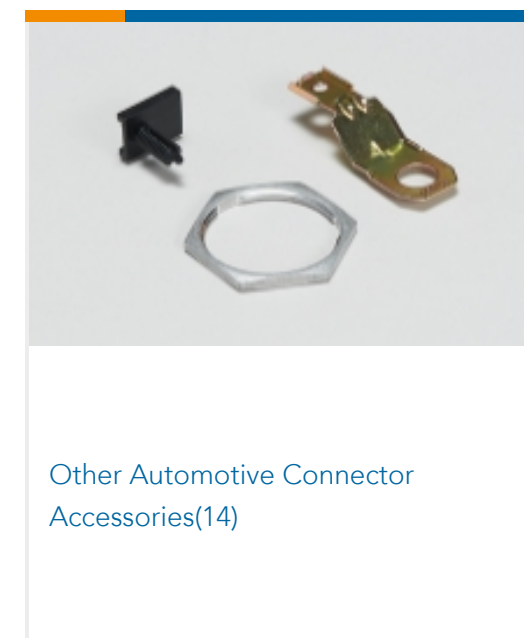
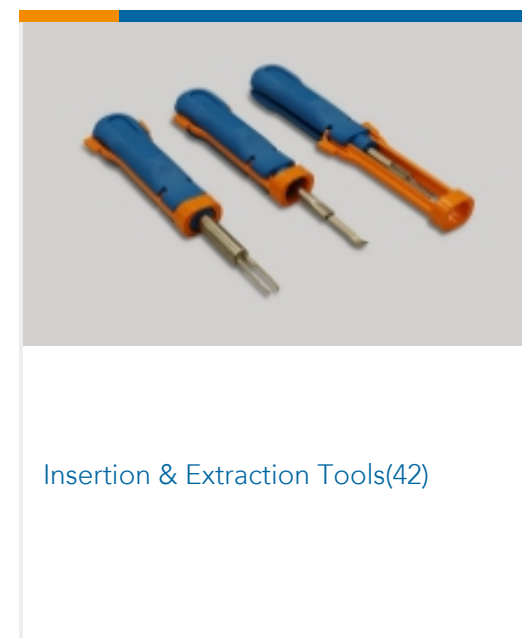
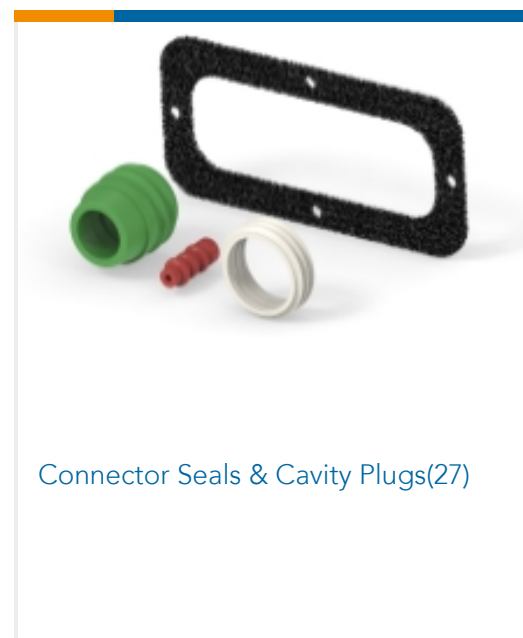
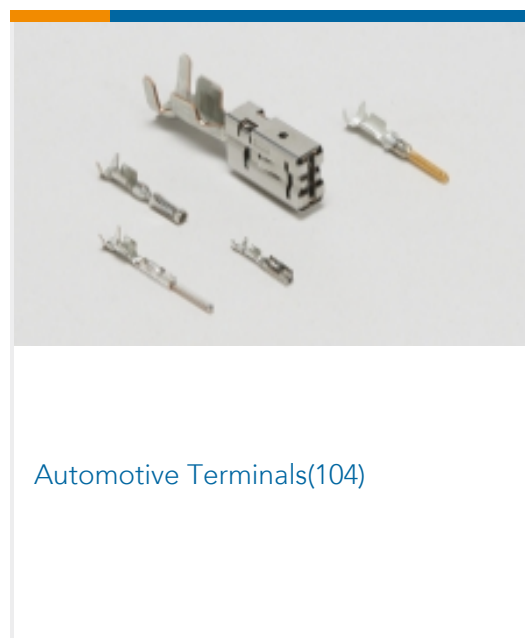
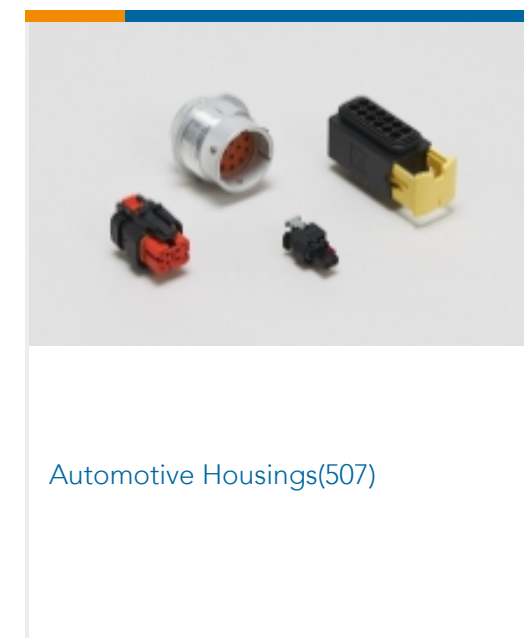
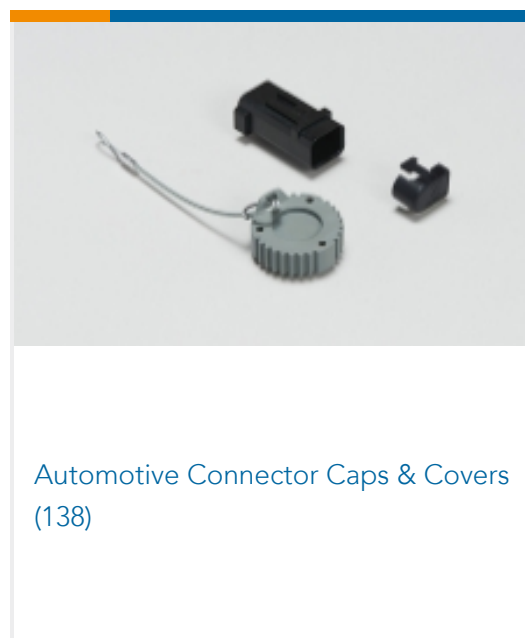

Customers Also Bought



Documents

CAD Files

Customer View Model

[ENG_CVM_CVM_963730-1_W.2d_dxf.zip](#)

English

3D PDF

3D

Customer View Model

[ENG_CVM_CVM_963730-1_W.3d_igs.zip](#)

English

Customer View Model

[ENG_CVM_CVM_963730-1_W.3d_stp.zip](#)

English

By downloading the CAD file I accept and agree to the [Terms and Conditions](#) of use.

Product Specifications

Application Specification

English