



AMP | Timer Connector System

TE Internal #: 963294-1

Single Wire Seal (SWS), Silicone, Blue, 5.2 mm [.205 in] Cavity Diameter, .047 – .083 in [1.2 – 2.1 mm] Insulation Diameter, Timer Connector System

[View on TE.com >](#)

Connectors > Connector Accessories > Connector Seals & Cavity Plugs

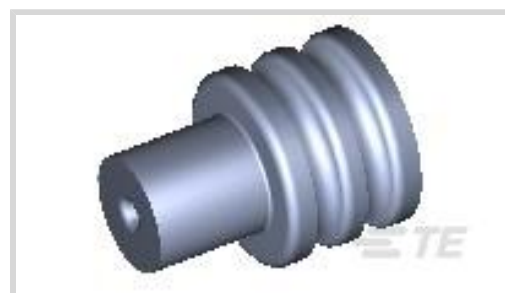

Connector Seal & Plug Type: **Single Wire Seal (SWS)**

Primary Product Material: **Silicone**

Primary Product Color: **Blue**

Cavity Diameter: **5.2 mm [.205 in]**

Compatible Insulation Diameter Range: **1.2 – 2.1 mm [.047 – .083 in]**

Features

Product Type Features

Connector Seal & Plug Type	Single Wire Seal (SWS)
----------------------------	------------------------

Body Features

Primary Product Material	Silicone
Primary Product Color	Blue

Dimensions

Cavity Diameter	5.2 mm[.205 in]
Compatible Insulation Diameter Range	1.2 – 2.1 mm[.047 – .083 in]

Usage Conditions

Operating Temperature (Max)	65 °C, 70 °C, 75 °C, 80 °C, 85 °C, 90 °C, 100 °C, 105 °C, 110 °C, 120 °C, 125 °C, 130 °C [149 °F][158 °F][167 °F][176 °F][185 °F][194 °F][212 °F][221 °F][230 °F][248 °F][257 °F][266 °F]
Operating Temperature Range	-40 – 130 °C[-40 – 266 °F]

Industry Standards

UL Flammability Rating	None
------------------------	------

Other

Resistance to Hydrocarbons	Poor
Shore A Hardness	50



Contains Lubricant	Yes
--------------------	-----

Product Compliance

[For compliance documentation, visit the product page on TE.com>](#)

EU RoHS Directive 2011/65/EU	Compliant
EU ELV Directive 2000/53/EC	Compliant
China RoHS 2 Directive MIIT Order No 32, 2016	No Restricted Materials Above Threshold
EU REACH Regulation (EC) No. 1907/2006	Current ECHA Candidate List: JUNE 2023 (235) Candidate List Declared Against: JUNE 2023 (235) Does not contain REACH SVHC
Halogen Content	Low Halogen - Br, Cl, F, I < 900 ppm per homogenous material. Also BFR/CFR/PVC Free
Solder Process Capability	Not applicable for solder process capability

Product Compliance Disclaimer

This information is provided based on reasonable inquiry of our suppliers and represents our current actual knowledge based on the information they provided. This information is subject to change. The part numbers that TE has identified as EU RoHS compliant have a maximum concentration of 0.1% by weight in homogenous materials for lead, hexavalent chromium, mercury, PBB, PBDE, DBP, BBP, DEHP, DIBP, and 0.01% for cadmium, or qualify for an exemption to these limits as defined in the Annexes of Directive 2011/65/EU (RoHS2). Finished electrical and electronic equipment products will be CE marked as required by Directive 2011/65/EU. Components may not be CE marked. Additionally, the part numbers that TE has identified as EU ELV compliant have a maximum concentration of 0.1% by weight in homogenous materials for lead, hexavalent chromium, and mercury, and 0.01% for cadmium, or qualify for an exemption to these limits as defined in the Annexes of Directive 2000/53/EC (ELV). Regarding the REACH Regulation, the information TE provides on SVHC in articles for this part number is based on the latest European Chemicals Agency (ECHA) 'Guidance on requirements for substances in articles' posted at this URL: <https://echa.europa.eu/guidance-documents/guidance-on-reach>

Compatible Parts



TE Part # CAT-M8793-CH8172
MQS, CONNECTOR HOUSING



TE Part # CAT-AM705-CH8172
AMP MCP, SEALED CONNECTOR HOUSING



TE Part # CAT-T4827-CH8172
Timer Connector Housing



TE Part # CAT-AM705-T273
AMP MCP, RECEPTACLE AND TAB



TE Part # CAT-T4827-T273
TIMER, RECEPTACLE AND TAB



TE Part # 1703661-1
6POS, MIXED, REC HSG, ASSY



TE Part # 3-2109313-2
060/110 HYB 8P SLD PLUG ASSY D



TE Part # 2138314-1
36P SEALED HYBRID (32X 1.2, 4X



TE Part # 2299450-1
14P TAB HOUSING ASSY



TE Part # 2209545-1
94P, MQS CB, REC HSG, ASSY, SEALED



TE Part # 1-284844-0
12 POS MCP HYBRID MALE CONNECTOR



TE Part # 2-2141892-1
JPT A REC 2.8 Contact SRC Au CONNECTOR



TE Part # 2209520-6
46POS. REC HOUSING ASSY



TE Part # 2349074-1
4POS, AMP MCP 2.8K, REC HSG ASSY



TE Part # 4-964300-1
TAB A 2.8x0.8 CONTACT SWS



TE Part # 2-966694-1
FLA-STE-GH2, 8RD2X5P



TE Part # 6-964300-6
TAB A 2.8x0.8 CONTACT SWS

Also in the Series | **Timer Connector System**



Automotive Connector Caps & Covers (12)



Automotive Connector Locks & Position Assurance (17)



Automotive Housings (233)



Automotive Terminals (145)

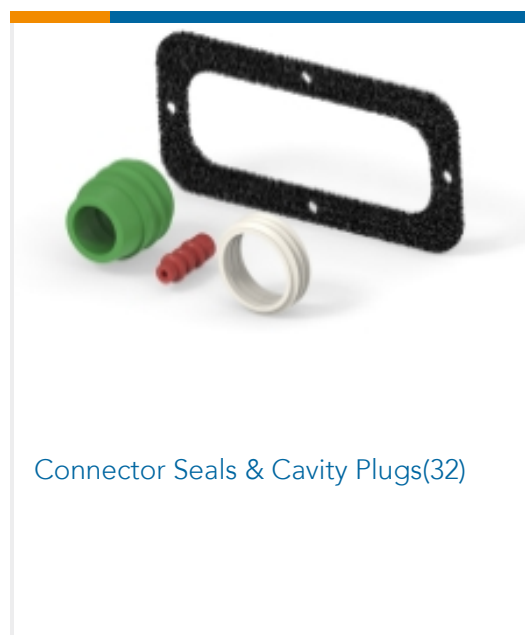

Connector Seals & Cavity Plugs(32)

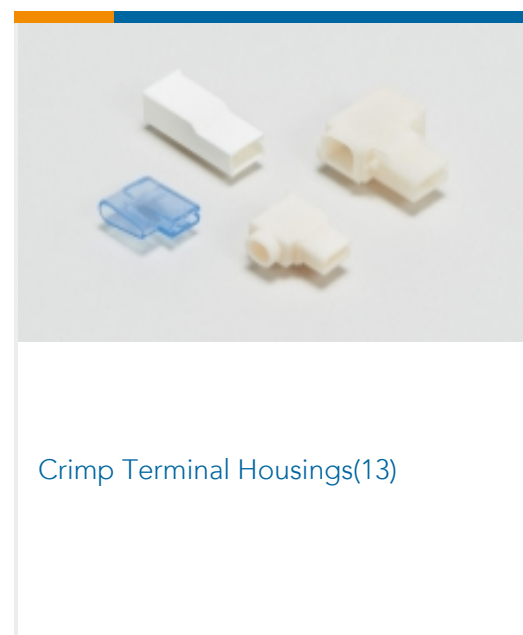

Crimp Terminal Housings(13)

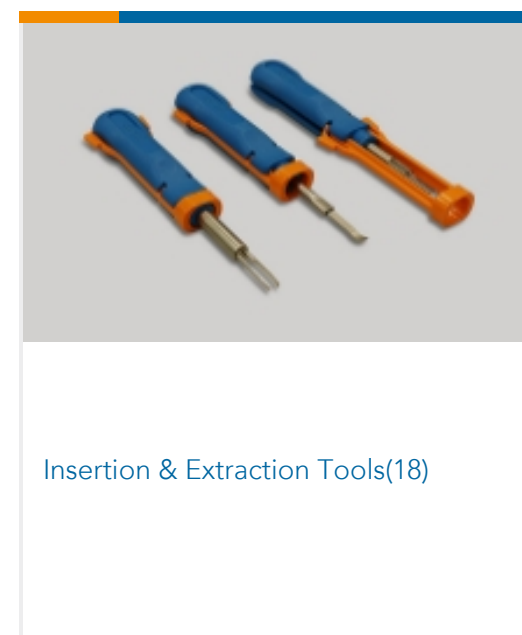

Insertion & Extraction Tools(18)

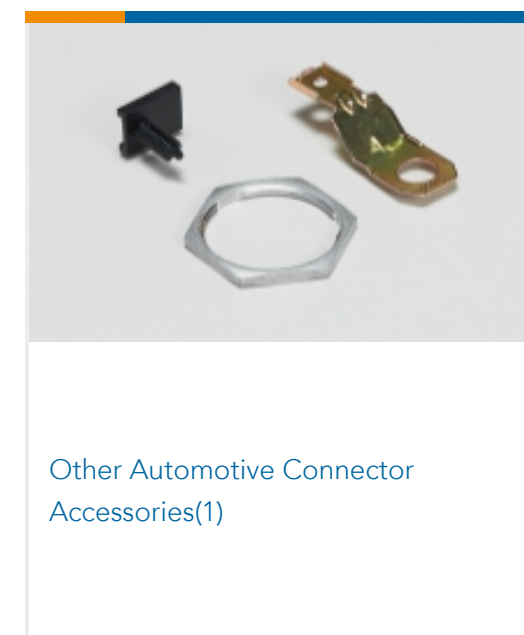

Other Automotive Connector Accessories(1)



PCB Headers & Receptacles(82)

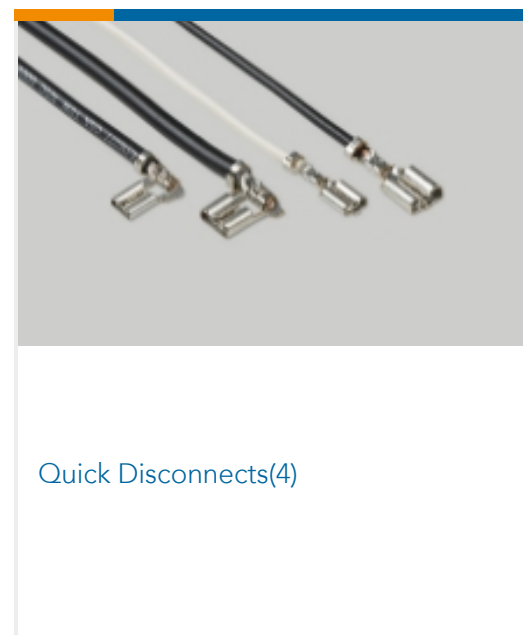

Quick Disconnects(4)

Customers Also Bought



TE Part #160860-4
FF 250 REC 0.5-1.0MM2 TPPB



TE Part #7-1768045-8
STD15Y-4



TE Part #1241390-1
AMP MCP 2.8K, CONTACT



TE Part #1443997-2
BASE ASSEMBLY, 60 POSITION, BB



TE Part #539515-000
ES2000-NO.3-B8-0-65MM

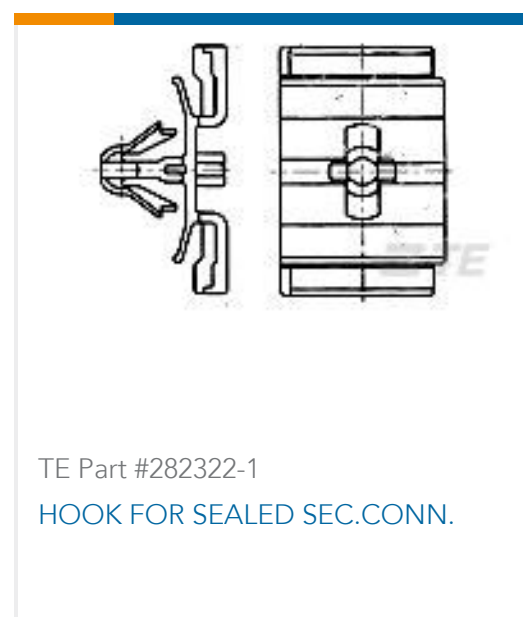

TE Part #282322-1
HOOK FOR SEALED SEC.CONN.

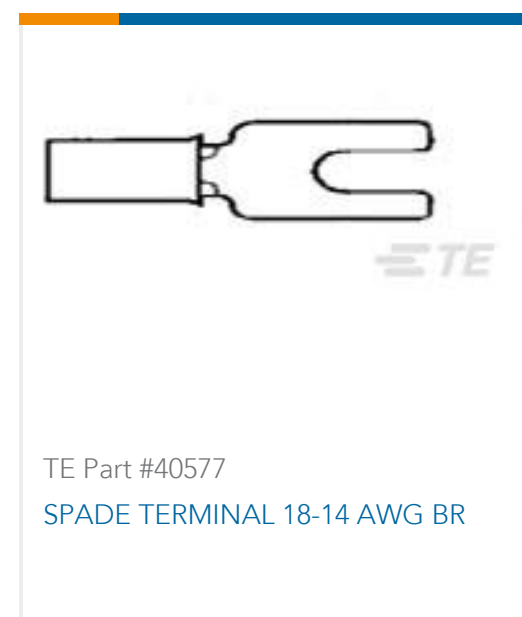

TE Part #40577
SPADE TERMINAL 18-14 AWG BR

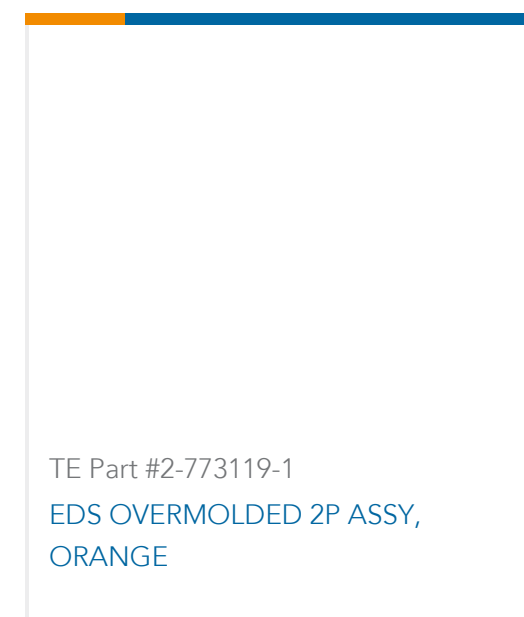

TE Part #2-773119-1
EDS OVERMOLDED 2P ASSY,
ORANGE

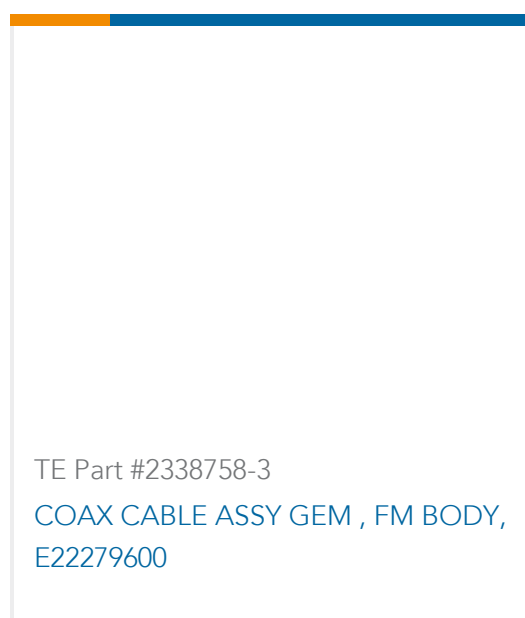

TE Part #2338758-3
COAX CABLE ASSY GEM, FM BODY,
E22279600



TE Part #626277-1
LAMP SOCKET CONTACT

Documents



Product Drawings

SINGLE WIRE SEAL INSULATION DI

English

CAD Files

Customer View Model

[ENG_CVM_CVM_963294-1_E.2d_dxf.zip](#)

English

3D PDF

3D

Customer View Model

[ENG_CVM_CVM_963294-1_E.3d_igs.zip](#)

English

Customer View Model

[ENG_CVM_CVM_963294-1_E.3d_stp.zip](#)

English

By downloading the CAD file I accept and agree to the [Terms and Conditions](#) of use.

Product Specifications

CAVITY PLUG (HYB 38P ISL PLUG)

English

Product Specification

Japanese

Product Specification

English

MQS CLEAN BODY PLUG ASSY 81P & 40P

Japanese

MQS CLEAN BODY PLUG ASSY 81P & 40P

Japanese

Product Specification

English

Instruction Sheets

Instruction Sheet (non U.S.)

English

Instruction Sheet (non U.S.)

Japanese