



AMP | Timer Connector System

TE Internal #: 963245-1

Single Wire Seal (SWS), Silicone, Yellow, 7.2 mm [.283 in] Cavity Diameter, .146 in [3.7 mm] Insulation Diameter, Timer Connector System

[View on TE.com >](#)

Connectors > Connector Accessories > Connector Seals & Cavity Plugs



Connector Seal & Plug Type: **Single Wire Seal (SWS)**

Primary Product Material: **Silicone**

Primary Product Color: **Yellow**

Cavity Diameter: **7.2 mm [.283 in]**

Compatible Insulation Diameter Range: **3.7 mm [.146 in]**

Features

Product Type Features

Connector Seal & Plug Type	Single Wire Seal (SWS)
----------------------------	------------------------

Body Features

Primary Product Material	Silicone
Primary Product Color	Yellow

Dimensions

Cavity Diameter	7.2 mm [.283 in]
Compatible Insulation Diameter Range	3.7 mm [.146 in]

Usage Conditions

Operating Temperature (Max)	65 °C, 70 °C, 75 °C, 80 °C, 85 °C, 90 °C, 100 °C, 105 °C, 110 °C, 120 °C, 125 °C, 130 °C [149 °F][158 °F][167 °F][176 °F][185 °F][194 °F][212 °F][221 °F][230 °F][248 °F][257 °F][266 °F]
Operating Temperature Range	-40 – 130 °C [-40 – 266 °F]

Industry Standards



UL Flammability Rating	None
------------------------	------

Other

Resistance to Hydrocarbons	Poor
----------------------------	------

Shore A Hardness	50
------------------	----

Contains Lubricant	Yes
--------------------	-----

Product Compliance

[For compliance documentation, visit the product page on TE.com>](#)

EU RoHS Directive 2011/65/EU	Compliant
------------------------------	-----------

EU ELV Directive 2000/53/EC	Compliant
-----------------------------	-----------

China RoHS 2 Directive MIIT Order No 32, 2016	No Restricted Materials Above Threshold
---	---

EU REACH Regulation (EC) No. 1907/2006	Current ECHA Candidate List: JUNE 2023 (235) Candidate List Declared Against: JUNE 2023 (235) Does not contain REACH SVHC
--	---

Halogen Content	Low Halogen - Br, Cl, F, I < 900 ppm per homogenous material. Also BFR/CFR/PVC Free
-----------------	---

Solder Process Capability	Not applicable for solder process capability
---------------------------	--

Product Compliance Disclaimer

This information is provided based on reasonable inquiry of our suppliers and represents our current actual knowledge based on the information they provided. This information is subject to change. The part numbers that TE has identified as EU RoHS compliant have a maximum concentration of 0.1% by weight in homogenous materials for lead, hexavalent chromium, mercury, PBB, PBDE, DBP, BBP, DEHP, DIBP, and 0.01% for cadmium, or qualify for an exemption to these limits as defined in the Annexes of Directive 2011/65/EU (RoHS2). Finished electrical and electronic equipment products will be CE marked as required by Directive 2011/65/EU. Components may not be CE marked. Additionally, the part numbers that TE has identified as EU ELV compliant have a maximum concentration of 0.1% by weight in homogenous materials for lead, hexavalent chromium, and mercury, and 0.01% for cadmium, or qualify for an exemption to these limits as defined in the Annexes of Directive 2000/53/EC (ELV). Regarding the REACH Regulation, the information TE provides on SVHC in articles for this part number is based on the latest European Chemicals Agency (ECHA) 'Guidance on requirements for substances in articles' posted at this URL: <https://echa.europa.eu/guidance-documents/guidance-on-reach>

Compatible Parts

TE Part # CAT-L489-CH8172
LEAVYSEAL Housings



TE Part # CAT-H3399-CH8172
Heavy Duty Sealed Connector Series Housings



TE Part # 1-1579007-6
EXTRACTION TOOL



TE Part # CAT-T4827-T273
TIMER, RECEPTACLE AND TAB



TE Part # CAT-T4827-CH8172
Timer Connector Housing



TE Part # CAT-R7602-T273
ROUND CONNECTOR SYSTEM, PIN AND SOCKET



TE Part # CAT-M8793-CH8172
MQS, CONNECTOR HOUSING



TE Part # 953318-2
1W HSG FOR DIESEL PLUG



TE Part # 953318-1
1W HSG FOR DIESEL PLUG



TE Part # 1379208-3
26W ASSY RECEPTACLE HSG



TE Part # 1379242-2
CONNECTOR 2P SPT



TE Part # 284818-1
1 POS CANDELETTE



TE Part # 284818-2
1 WAYS CONNECTOR F.GLOW PLUG - RED VERS.



TE Part # 953631-1
1W HSG DIESEL GLOW PLUG

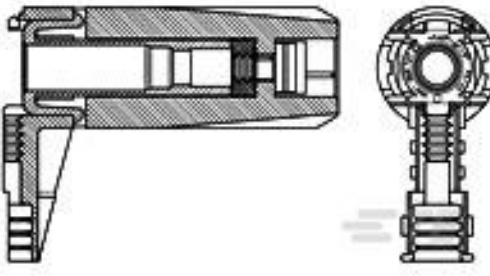

TE Part # 967568-1
4.0 DIA SYS REC HSG



TE Part # 282956-3
SPLASH-PROOF FEM.CONN.ASS



TE Part # 1-927835-3
STD PW TIMER CONTACT



TE Part # 1-969044-5
STD PW TIMER CONTACT TYPE A



TE Part # 2-927835-1
STD PW TIMER CONTACT



TE Part # 2-928966-1
STD PW TIMER CONTACT

Also in the Series | **Timer Connector System**



Automotive Connector Caps & Covers (12)

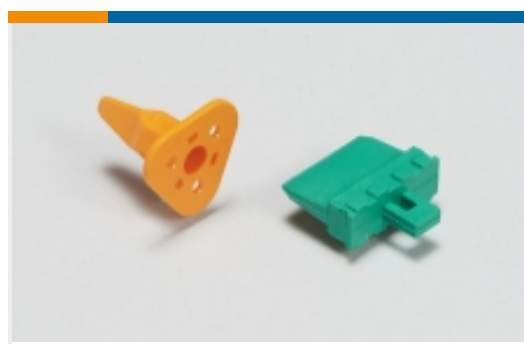

Automotive Connector Locks & Position Assurance (17)

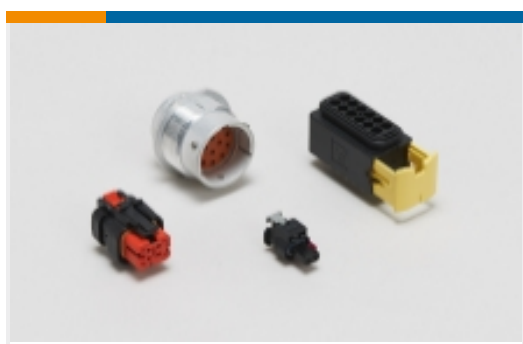

Automotive Housings (233)

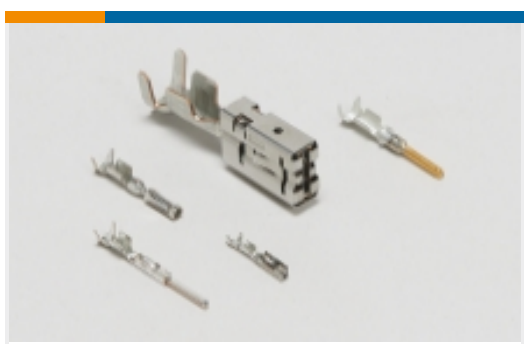

Automotive Terminals (145)



Connector Seals & Cavity Plugs (32)



Crimp Terminal Housings (13)



Insertion & Extraction Tools (18)



Other Automotive Connector Accessories (1)



PCB Headers & Receptacles (82)

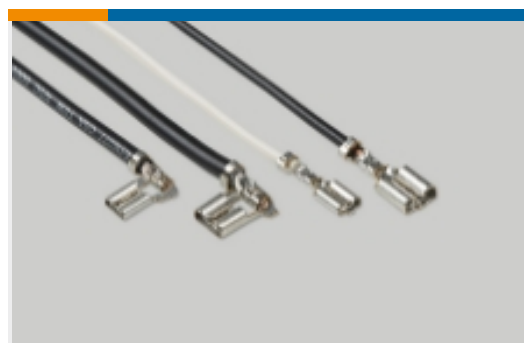

Quick Disconnects (4)

Customers Also Bought



TE Part #8638626096
RNF-3000-18/6-0-80MM



TE Part #85011-1
RUBBER PLUG FOR SEALED CONN.



TE Part #1743757-2
SPT SEALED 3P CAP HSG



TE Part #2005390-6
JPT SLD 3P PLUG ASSY-1S BLK



TE Part #2326911-6
FAKRA AUT,SOC HSG,UNSLD,
180DEG,COD F



TE Part #968043-1
SINGLE WIRE SEAL

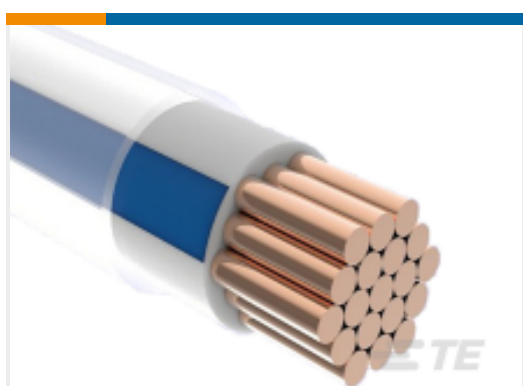

TE Part #D248123001
ACW0219-0.50-42(NS)



TE Part #6137703001
ACW0219-0.50-92(NS)



Documents

Product Drawings

[EINZELLEIT-DICHTUNG](#)

English

CAD Files

Customer View Model

[ENG_CVM_963245-1_C.3d_igs.zip](#)

English

Customer View Model

[ENG_CVM_963245-1_C.3d_stp.zip](#)

English

Customer View Model

[ENG_CVM_963245-1_C.2d_dxf.zip](#)

English

3D PDF

English

By downloading the CAD file I accept and agree to the [Terms and Conditions](#) of use.

Product Specifications

[Application Specification](#)

English

[Application Specification](#)

English

Instruction Sheets

[Instruction Sheet \(non U.S.\)](#)

French

[Instruction Sheet \(non U.S.\)](#)

French