

937317-1 ✓ ACTIVE

Mini-CT

TE Internal #: 937317-1

TE Internal Description: MIMI CT PISTOL TOOL

[View on TE.com >](#)



Product Compliance













[For compliance documentation, visit the product page on TE.com>](#)

| | |
|---|--|
| EU RoHS Directive 2011/65/EU | Compliant |
| EU ELV Directive 2000/53/EC | Compliant |
| China RoHS 2 Directive MIIT Order No 32, 2016 | No Restricted Materials Above Threshold |
| EU REACH Regulation (EC) No. 1907/2006 | Current ECHA Candidate List: JUNE 2023 (235) Candidate List Declared Against: JAN 2021 (211) Does not contain REACH SVHC |
| Halogen Content | Low Halogen - Br, Cl, F, I < 900 ppm per homogenous material. Also BFR/CFR/PVC Free |
| Solder Process Capability | Not applicable for solder process capability |

Product Compliance Disclaimer

This information is provided based on reasonable inquiry of our suppliers and represents our current actual knowledge based on the information they provided. This information is subject to change. The part numbers that TE has identified as EU RoHS compliant have a maximum concentration of 0.1% by weight in homogenous materials for lead, hexavalent chromium, mercury, PBB, PBDE, DBP, BBP, DEHP, DIBP, and 0.01% for cadmium, or qualify for an exemption to these limits as defined in the Annexes of Directive 2011/65/EU (RoHS2). Finished electrical and electronic equipment products will be CE marked as required by Directive 2011/65/EU. Components may not be CE marked. Additionally, the part numbers that TE has identified as EU ELV compliant have a maximum concentration of 0.1% by weight in homogenous materials for lead, hexavalent chromium, and mercury, and 0.01% for cadmium, or qualify for an exemption to these limits as defined in the Annexes of Directive 2000/53/EC (ELV). Regarding the REACH Regulation, the information TE provides on SVHC in articles for this part number is based on the latest European Chemicals Agency (ECHA) 'Guidance on requirements for substances in articles' posted at this URL: <https://echa.europa.eu/guidance-documents/guidance-on-reach>

Compatible Parts

| | | | |
|--|---|--|---|
|  <p>TE Part # 1-353293-9 MINI CT MT REC ASSY 19P GRAY</p> |  <p>TE Part # 1-353293-7 MINI CT MT REC ASSY 17P GRAY</p> |  <p>TE Part # 2-353293-0 MINI CT MT REC ASSY 20P GRAY</p> |  <p>TE Part # 1-353293-6 MINI CT MT REC ASSY 16P GRAY</p> |
|  <p>TE Part # 1-353293-1 MINI CT MT REC ASSY 11P GRAY</p> |  <p>TE Part # 1-353293-8 MINI CT MT REC ASSY 18P GRAY</p> |  <p>TE Part # 353293-2 MINI CT MT REC ASSY 2P GRAY</p> |  <p>TE Part # 353293-8 MINI CT MT REC ASSY 8P GRAY</p> |
|  <p>TE Part # 353293-6 MINI CT MT REC ASSY 6P GRAY</p> |  <p>TE Part # 1-353293-3 MINI CT MT REC ASSY 13P GRAY</p> |  <p>TE Part # 1-353293-4 MINI CT MT REC ASSY 14P GRAY</p> |  <p>TE Part # 5-353293-3 MINI CT MT REC ASSY 3P BLUE</p> |
|  <p>TE Part # 1-353293-2 MINI CT MT REC ASSY 12P GRAY</p> |  <p>TE Part # 1-353293-0 MINI CT MT REC ASSY 10P GRAY</p> |  <p>TE Part # 1-353293-5 1.5 MINI-CT RECEPTACLE</p> |  <p>TE Part # 353293-7 MINI CT MT REC ASSY 7P GRAY</p> |
|  <p>TE Part # 353293-5 MINI CT MT REC ASSY 5P GRAY</p> |  <p>TE Part # 353293-9 MINI CT MT REC ASSY 9P GRAY</p> |  <p>TE Part # 3-353293-1 1.5MM CT MT REC ASSY 11P BLACK</p> |  <p>TE Part # 353293-4 MINI CT MT REC ASSY 4P GRAY</p> |

Also in the Series | **Mini-CT**



Lighting Cable Assemblies(2)



PCB Connector Mounting(10)

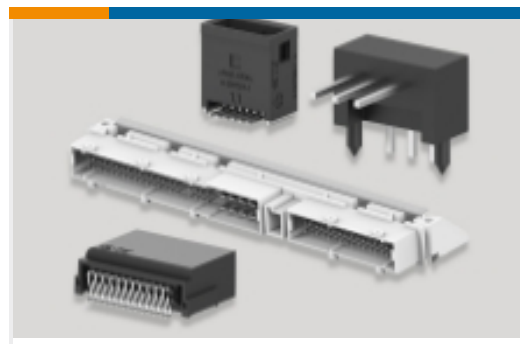

PCB Headers & Receptacles(9)



Rectangular Power Connectors(1)



Wire-to-Board Connector Contacts(1)

Customers Also Bought

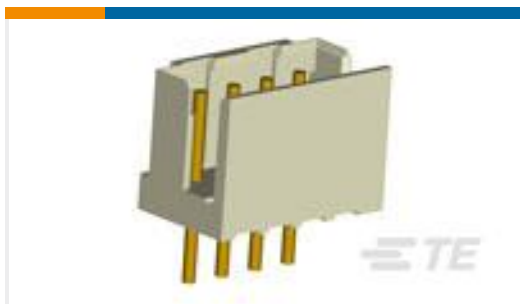

TE Part #292132-7
CT P/HDR BOX V 7P NAT



TE Part #353908-3
CT REC HSG 3P CRIMP TYPE WHITE



TE Part #292206-3
MINI CT SGL DIP H 3P NAT



TE Part #823748-000
382A012-4-0

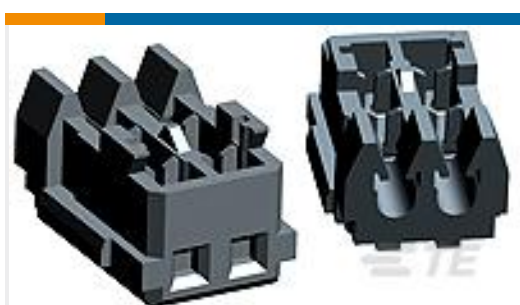

TE Part #353293-2
MINI CT MT REC.ASSY 2P GRAY

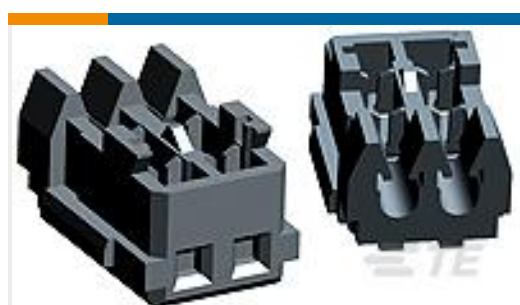

TE Part #353293-6
MINI CT MT REC ASSY 6P GRAY



TE Part #1-292207-4
MINI CT SGL DIP V 14P NAT



TE Part #1-353293-0
MINI CT MT REC.ASSY 10P GRAY



TE Part #2058943-5
Cable Assembly Mini CT 6 pos.

Documents



Product Drawings

MIMI CT PISTOL TOOL

English

Instruction Sheets

PISTOL GRIP TOOL FOR MINI CT CONNECTOR

Japanese

Instruction Sheet (non U.S.)

Japanese