

929967-1 ✓ ACTIVE

AMP | Round Connector System

TE Internal #: 929967-1

Automotive Terminals, Pin, Pin Diameter 2.5 mm [.098 in], 20 – 17 AWG Wire Size, .5 – 1 mm² Wire Size, Sealable, Round Connector System

[View on TE.com >](#)



Terminals & Splices > Automotive Terminals > ROUND CONNECTOR SYSTEM, PIN AND SOCKET



Terminal Type: Pin

Mating Pin Diameter: 2.5 mm [.098 in]

Terminal Transmits: 25 – 40 A (Power)

Wire Size: .5 – 1 mm²

[All ROUND CONNECTOR SYSTEM, PIN AND SOCKET \(60\)](#)

Features

Product Type Features

Receptacle Style	180°
Sealable	Yes
Primary Locking Feature	Locking Lance

Body Features

Terminal Seal Type	Single Wire Seal (SWS)
--------------------	------------------------

Contact Features

Contact Size	2.5mm
Contact Fabrication	Stamped & Formed
Wire Contact Termination Area Plating Material	Tin
Typical Current Rating	40 A
Crimp Type	F-Crimp
Terminal Type	Pin
Mating Pin Diameter	2.5 mm[.098 in]
Interface Plating	Tin (Sn)

Termination Features

Termination Method to Wire & Cable	Crimp
------------------------------------	-------



Product Terminates To

Wire

Dimensions

Compatible Insulation Diameter Range

1.2 – 2.1 mm [.047 – .082 in]

Wire Size

.5 – 1 mm²

Wire Size Search

17 AWG, 18 AWG, 19 AWG, 20 AWG

Usage Conditions

Insulation Option

Uninsulated

Operating Temperature (Max)

80 °C, 85 °C, 90 °C, 100 °C, 105 °C, 110 °C, 120 °C, 125 °C, 130 °C [176 °F][185 °F][194 °F][212 °F][221 °F][230 °F][248 °F][257 °F][266 °F]

Operating Temperature Range

-40 – 130 °C [-40 – 266 °F]

Operation/Application

Compatible With Wire Base Material

Copper

Packaging Features

Packaging Quantity

3000

Packaging Method

Reel

Other

Terminal Transmits

25 – 40 A (Power)

Product Compliance

For compliance documentation, visit the product page on [TE.com](https://www.te.com)>

EU RoHS Directive 2011/65/EU

Compliant

EU ELV Directive 2000/53/EC

Compliant

China RoHS 2 Directive MIIT Order No 32, 2016

No Restricted Materials Above Threshold

EU REACH Regulation (EC) No. 1907/2006

Current ECHA Candidate List: JUNE 2023 (235)
 Candidate List Declared Against: JUNE 2023 (235)
 Does not contain REACH SVHC

Halogen Content

Low Halogen - Br, Cl, F, I < 900 ppm per homogenous material. Also BFR/CFR/PVC Free

Solder Process Capability

Not applicable for solder process capability

Product Compliance Disclaimer

This information is provided based on reasonable inquiry of our suppliers and represents our current actual knowledge based on the information they provided. This information is subject to change. The part numbers that TE has identified as EU RoHS compliant have a maximum concentration of 0.1% by weight in homogenous materials for lead, hexavalent chromium, mercury, PBB, PBDE, DBP, BBP, DEHP, DIBP, and 0.01% for cadmium, or qualify for an exemption to these limits as defined in the Annexes of Directive 2011/65/EU (RoHS2). Finished electrical and electronic equipment products will be CE marked as required by Directive 2011/65/EU. Components may not be CE marked. Additionally, the part numbers that TE has identified as EU ELV compliant have a maximum concentration of 0.1% by weight in homogenous materials for lead, hexavalent chromium, and mercury, and 0.01% for cadmium, or qualify for an exemption to these limits as defined in the Annexes of Directive 2000/53/EC (ELV). Regarding the REACH Regulation, the information TE provides on SVHC in articles for this part number is based on the latest European Chemicals Agency (ECHA) 'Guidance on requirements for substances in articles' posted at this URL: <https://echa.europa.eu/guidance-documents/guidance-on-reach>

Compatible Parts



TE Part # CAT-C4962-CH8172
Circular DIN Housings



TE Part # 58606-1
PROCRIMP 1.5 & 2.5MM PIN/SEAL



TE Part # 1-1579007-8
EXTRACTION TOOL



TE Part # 828920-1
EINZELADERDICHTUNG



TE Part # 2305570-1
Strip Terminal Cutter-Side Feed-No Crimp



TE Part # 2151139-1
OCEAN-2.0-APPLICATOR-S-080F160OV



TE Part # 2151139-2
OCEAN-2.0-APPLICATOR-S-080F160OV



TE Part # 2387332-1
SDE F 2.5mm CONTACT 0.35-1.0mm2 ASSY



TE Part # 2387332-2
SDE F 2.5mm CONTACT 0.35-1.0mm2 DIE SET



TE Part # 5-2151139-1
OCEAN-2.0-APPLICATOR-S-080F160OV



TE Part # 5-2151139-2
OCEAN-2.0-APPLICATOR-S-080F160OV



TE Part # 58606-2
PC DIE 1.5 & 2.5 PIN W/S



TE Part # 7-2151139-1
OCEAN-2.0-APPLICATOR-S-080F160OV



TE Part # 7-2151139-2
OCEAN-2.0-APPLICATOR-S-080F160OV



TE Part # 7-2151139-7
OCEAN_2.0_SPARE_PART_KIT-080F160OV



TE Part # 7-2266055-7
OC-080F160O-CRIMP TOOLINGKIT



Also in the Series | Round Connector System

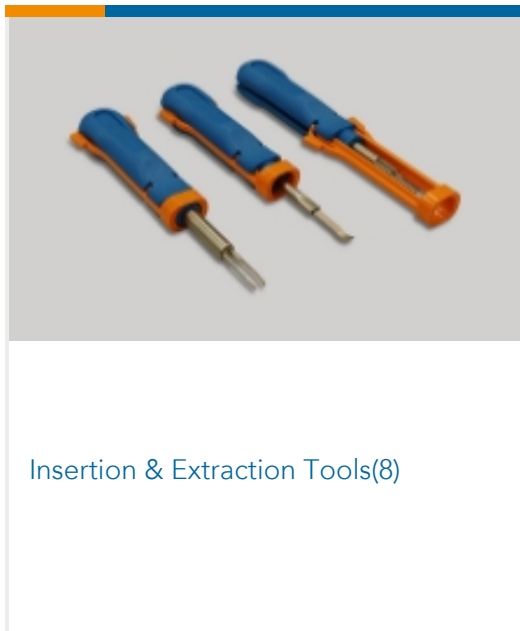
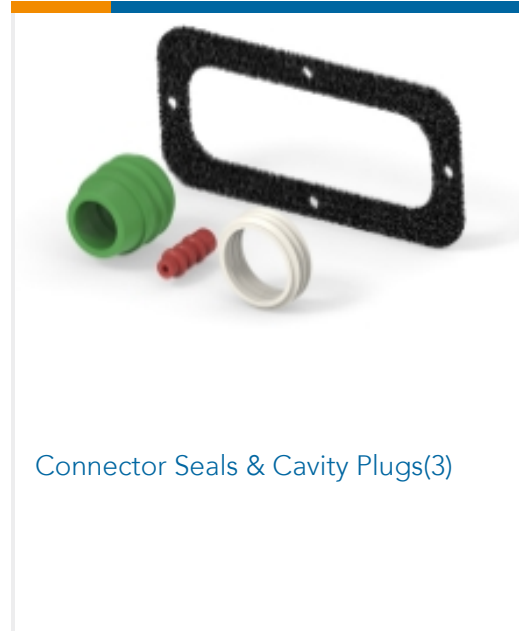
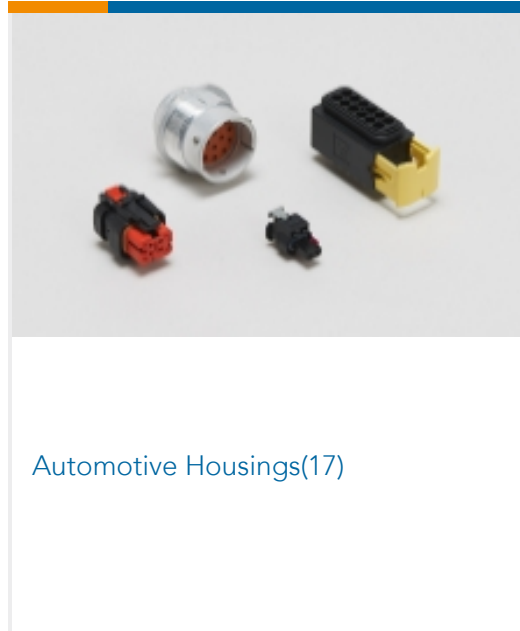
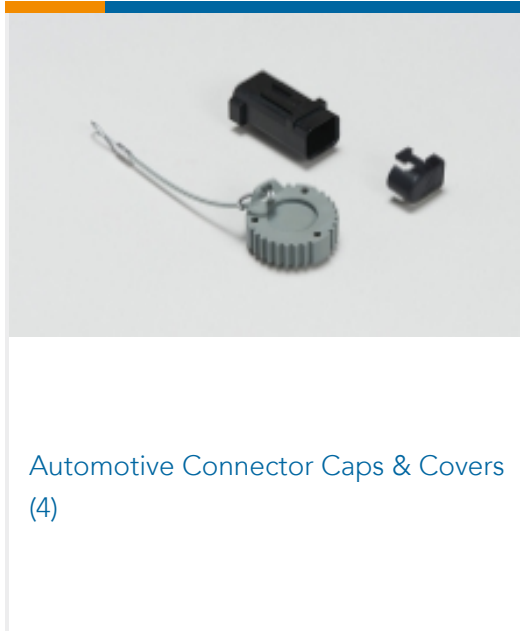

Customers Also Bought

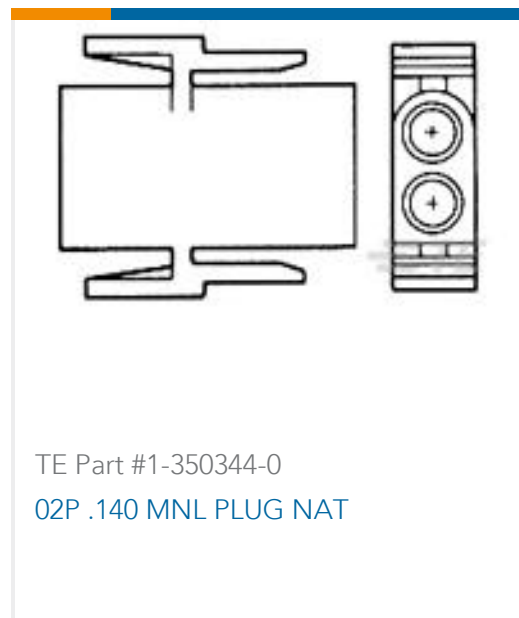



Documents

Product Drawings

[STIFTKONTAKT 2,5MMD](#)

English

[STIFTKONTAKT 2,5MMD](#)

English

CAD Files

Customer View Model

[ENG_CVM_929967-1_A2.3d_igs.zip](#)

English

Customer View Model

[ENG_CVM_929967-1_A2.3d_stp.zip](#)

English

Customer View Model

[ENG_CVM_929967-1_A2.2d_dxf.zip](#)

English

[3D PDF](#)

English

By downloading the CAD file I accept and agree to the [Terms and Conditions](#) of use.

Datasheets & Catalog Pages

[CONNECTOR SELECTOR](#)

English

Product Specifications

[Application Specification](#)

English

[Application Specification](#)

English