



Positive Lock | Positive Lock 250

TE Internal #: 928901-3

Quick Disconnects, Receptacle, 17 – 13 AWG Wire Size, 1.03 – 2.62 mm² Wire Size, Mating Tab Width 6.35 mm [.25 in], Straight, Brass, Positive Lock 250

[View on TE.com >](#)

Terminals & Splices > Quick Disconnects



Quick Disconnect Terminal Type: **Receptacle**

Wire Size: **1.03 – 2.62 mm²**

Mating Tab Width: **6.35 mm [.25 in]**

Mating Tab Thickness: **.81 mm [.032 in]**

Features

Product Type Features

Insertion Force	Low
-----------------	-----

Configuration Features

Connection Capacity	Single
Compatible With Wire & Cable Type	Discrete Wire

Contact Features

Quick Disconnect Terminal Type	Receptacle
Mating Tab Width	6.35 mm [.25 in]
Mating Tab Thickness	.81 mm [.032 in]
Terminal Orientation	Straight
Contact Base Material	Brass
Terminal Plating Material	Tin
Crimp Type	F-Crimp
Barrel Type	Open

Termination Features

--	--



Product Terminates To	Wire & Cable
-----------------------	--------------

Mechanical Attachment

Wire Insulation Support	With
Mating Retention Type	Dimple

Dimensions

Terminal Material Thickness	.41 mm[.016 in]
Product Length	22.3 mm[.88 in]
Compatible Insulation Diameter Range	3.1 – 4.3 mm[.12 – .169 in]
Wire Size	1.03 – 2.62 mm ²

Usage Conditions

Insulation Option	Uninsulated
Operating Temperature Range	-40 – 110 °C[-40 – 230 °F]

Industry Standards

Agency/Standard	UL
-----------------	----

Packaging Features

Packaging Quantity	1200
Packaging Method	Loose Piece/Carton

Other

Terminals & Splices Comment	FLK-Wire: Normal Wire
-----------------------------	-----------------------

Product Compliance





[For compliance documentation, visit the product page on TE.com>](#)

EU RoHS Directive 2011/65/EU	Compliant
EU ELV Directive 2000/53/EC	Compliant
China RoHS 2 Directive MIIT Order No 32, 2016	No Restricted Materials Above Threshold
EU REACH Regulation (EC) No. 1907/2006	Current ECHA Candidate List: JUNE 2023 (235) Candidate List Declared Against: JUNE 2023 (235) Does not contain REACH SVHC
Halogen Content	Low Halogen - Br, Cl, F, I < 900 ppm per homogenous material. Also BFR/CFR/PVC Free
Solder Process Capability	Not applicable for solder process capability

Product Compliance Disclaimer

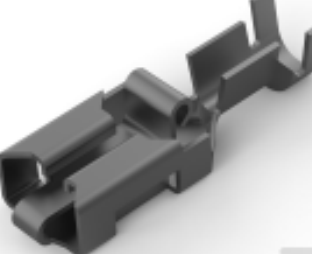
This information is provided based on reasonable inquiry of our suppliers and represents our current actual knowledge based on the information they provided. This information is subject to change. The part numbers that TE has identified as EU RoHS compliant have a maximum concentration of 0.1% by weight in homogenous materials for lead, hexavalent chromium, mercury, PBB, PBDE, DBP, BBP, DEHP, DIBP, and 0.01% for cadmium, or qualify for an exemption to these limits as defined in the Annexes of Directive 2011/65/EU (RoHS2). Finished electrical and electronic equipment products will be CE marked as required by Directive 2011/65/EU. Components may not be CE marked. Additionally, the part numbers that TE has identified as EU ELV compliant have a maximum concentration of 0.1% by weight in homogenous materials for lead, hexavalent chromium, and mercury, and 0.01% for cadmium, or qualify for an exemption to these limits as defined in the Annexes of Directive 2000/53/EC (ELV). Regarding the REACH Regulation, the information TE provides on SVHC in articles for this part number is based on the latest European Chemicals Agency (ECHA) 'Guidance on requirements for substances in articles' posted at this URL: <https://echa.europa.eu/guidance-documents/guidance-on-reach>

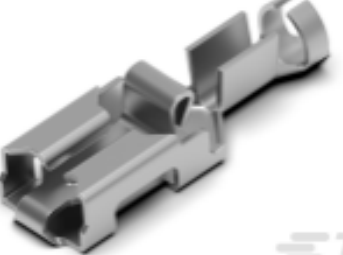
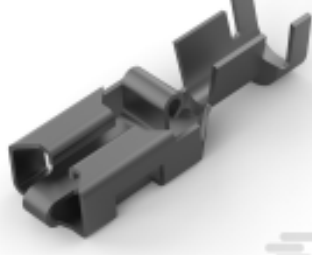
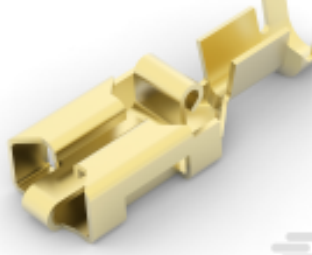
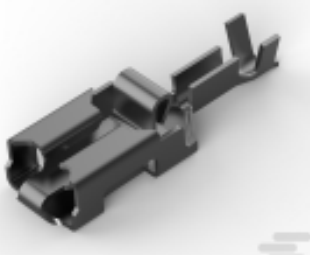
Compatible Parts

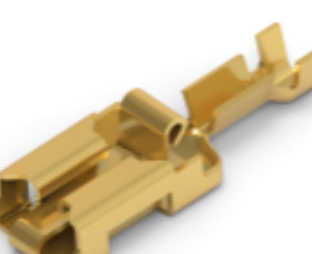
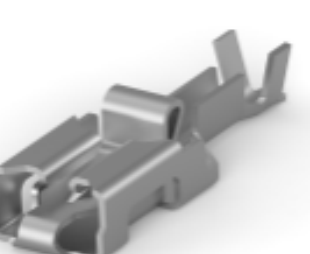
 <p>TE Part # 341001-6 PL 250 REC TERMINAL 13-11 PTPB LP</p>	 <p>TE Part # 341002-6 PL 250 REC TERMINAL 18-14 PTPB LP</p>	 <p>TE Part # 170265-2 PL 250 REC 12-10 AWG 0.406 X 42.3</p>	 <p>TE Part # 737015-3 PL TERMINAL RECEPTACLE 4-6 MM2 PTPBR</p>
 <p>TE Part # 928901-4 PL 250 REC TERMINAL 17-13 TPPB LP</p>	 <p>TE Part # 341001-3 PL 250 REC TERMINAL 13-11 TPBR LP</p>	 <p>TE Part # 341002-1 PL 250 REC TERMINAL 18-14 AWG BR LP</p>	 <p>TE Part # 927853-6 PL 250 REC TERMINAL 20-17 PTPB LP</p>
 <p>TE Part # 170265-4 PL 250 REC 12-10 AWG 0.406 X 42.3 TPPBZ</p>	 <p>TE Part # 341001-1 FASTON 250 REC 13-11 AWG BR LP</p>	 <p>TE Part # 1337265-1 POS LOCK RECEPTACLE GOLD</p>	 <p>TE Part # 927853-8 PL 250 REC 20-17 AWG AgBR</p>



Also in the Series | Positive Lock 250

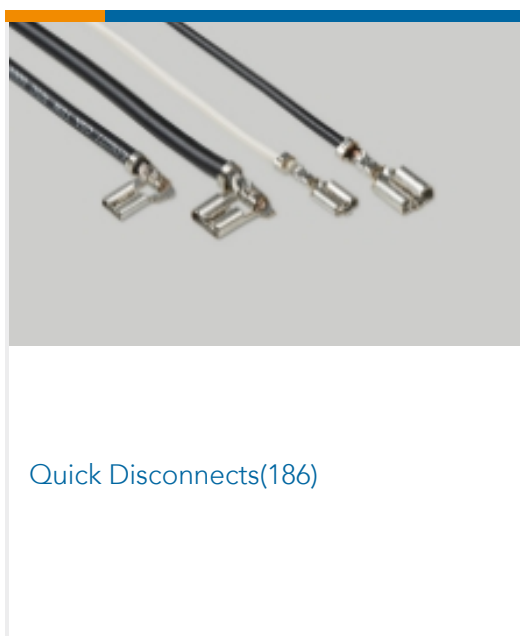
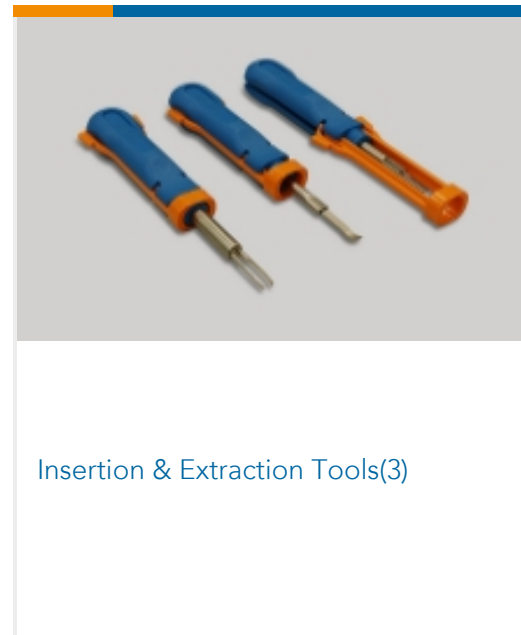
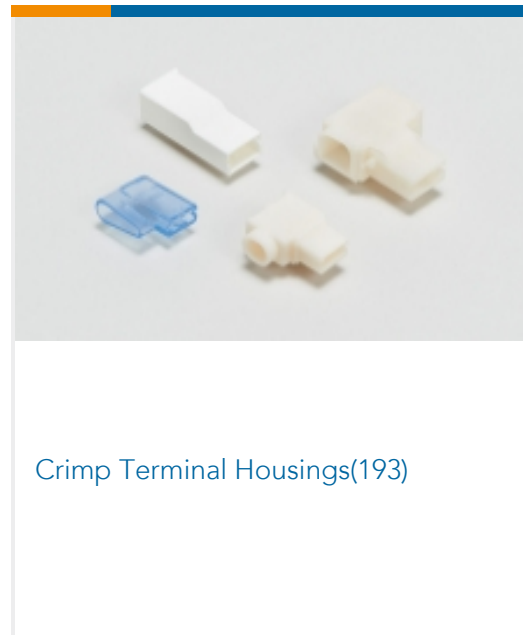
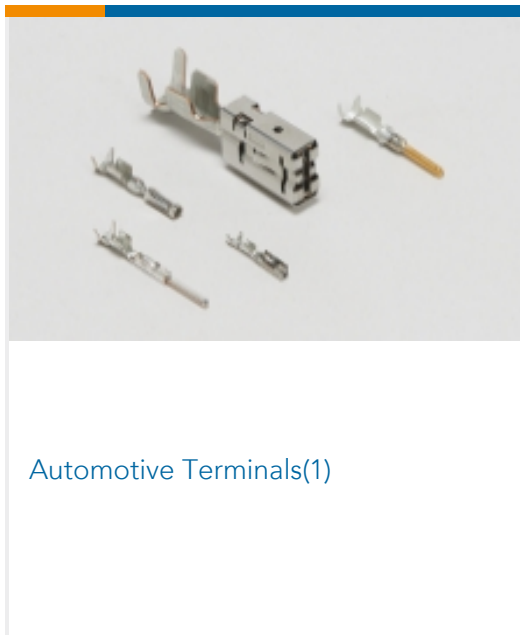

Customers Also Bought

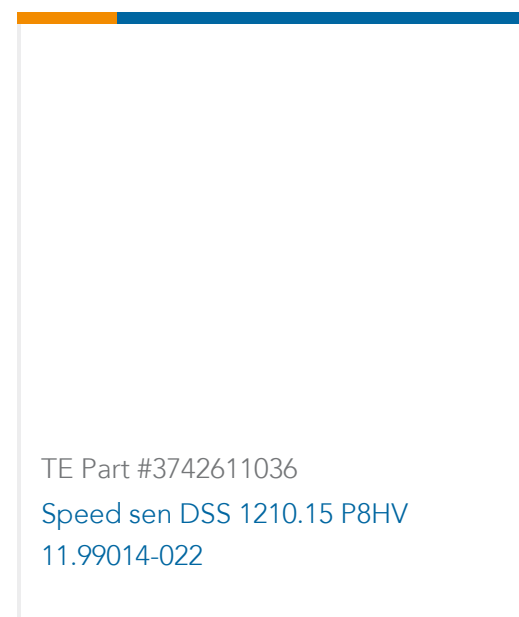
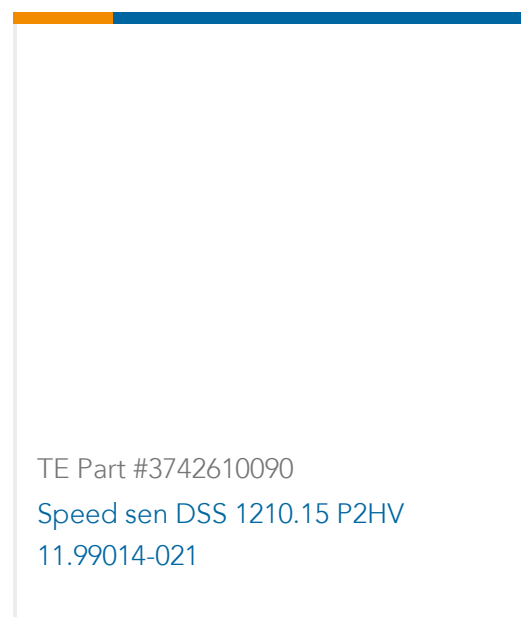
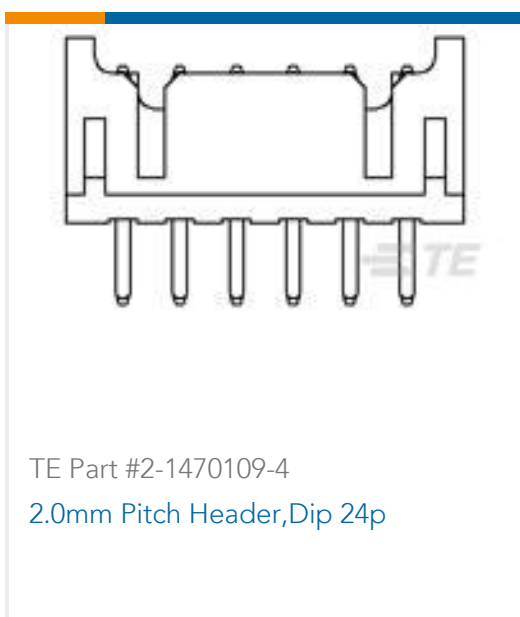



Documents

Product Drawings

[PL 250 REC TERMINAL 17-13 AWG TPBR LP](#)

English

[PL 250 REC TERMINAL 17-13 AWG TPBR LP](#)

English

CAD Files

[3D PDF](#)

3D

Customer View Model

[ENG_CVM_CVM_928901-3_F.2d_dxf.zip](#)

English

Customer View Model

[ENG_CVM_CVM_928901-3_F.3d_igs.zip](#)

English

Customer View Model

[ENG_CVM_CVM_928901-3_F.3d_stp.zip](#)

English

By downloading the CAD file I accept and agree to the [Terms and Conditions](#) of use.

Datasheets & Catalog Pages

[1654742_HOUSEHOLD_APPLIANCES_RAST5](#)

English

Product Environmental Compliance

[Product Compliance](#)

English

[Product Compliance](#)

English