



**MAG-MATE**

TE Internal #: 928770-2

Magnet Wire Terminals, Leaf, Mating Tab Width .134 in [3.4 mm],

Size 2, .67 – .95 mm Magnet Wire, 22 – 20 AWG Magnet Wire,

MAG-MATE

[View on TE.com >](#)

Terminals & Splices > Magnet Wire Terminals

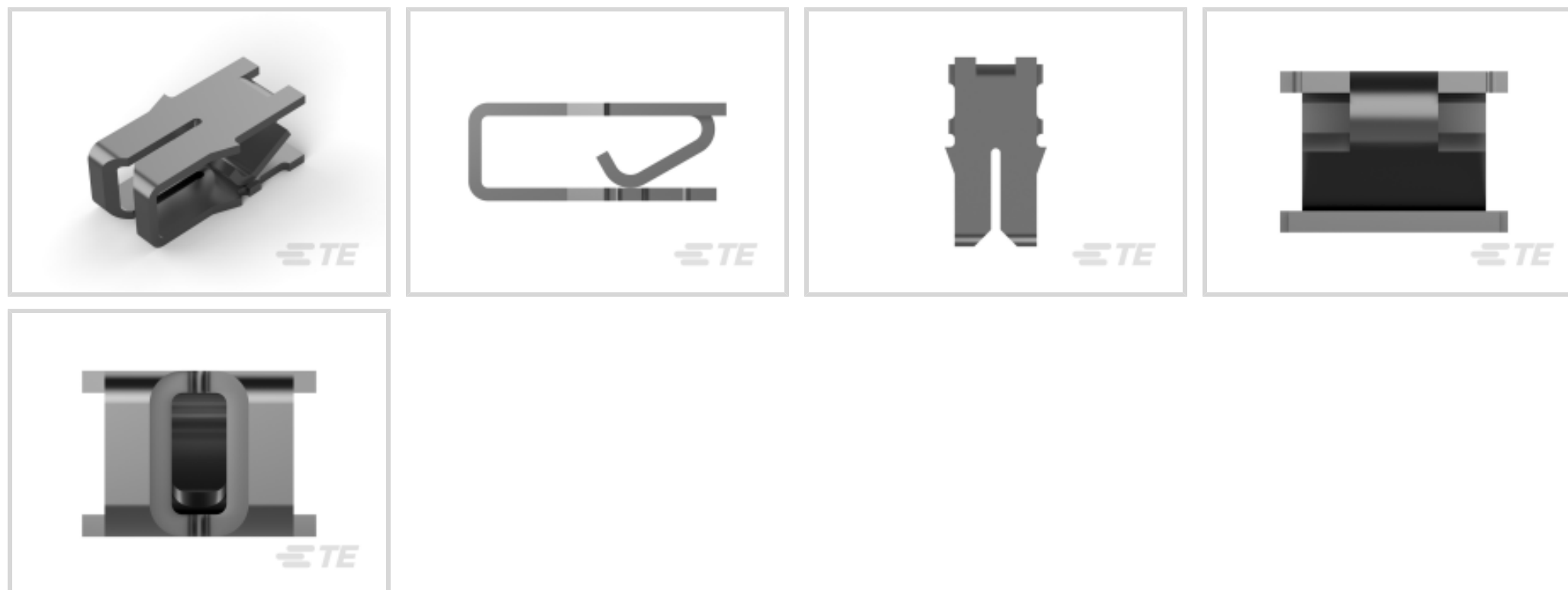

Magnet Wire Terminal Type: **Leaf**

Mating Tab Width: **3.4 mm [ .134 in ]**

Mating Tab Thickness: **.5 mm [ .02 in ]**

Compatible With Cavity Size: **Size 2**

Magnet Wire Size: **22 – 20 AWG**

**Features**

**Product Type Features**

Compatible With Discrete Wire Type	Magnet Wire, Solid
------------------------------------	--------------------

**Body Features**

Compatible With Cavity Size	Size 2
-----------------------------	--------

**Contact Features**

Magnet Wire Terminal Type	Leaf
Mating Tab Width	3.4 mm[.134 in]
Mating Tab Thickness	.5 mm[.02 in]
Terminal Plating Material	Tin
Terminal Orientation	Twisted

**Termination Features**

Termination Method to Wire & Cable	Insulation Displacement (IDC)
------------------------------------	-------------------------------

**Dimensions**

Terminal Height	7.6 mm[.3 in]
-----------------	---------------



Magnet Wire Size	.67 – .95 mm
------------------	--------------

Stock Thickness (Magnet Wire Side)	.4 mm [.016 in]
------------------------------------	-----------------

Product Length	7.6 mm [.78 in]
----------------	-----------------

### Usage Conditions

Insulation Option	Uninsulated
-------------------	-------------

Operating Temperature Range	-65 – 150 °C [-85 – 302 °F]
-----------------------------	-----------------------------

### Operation/Application

Compatible With Wire Base Material	Copper
------------------------------------	--------

### Identification Marking

Identification Number	15
-----------------------	----

### Packaging Features

Packaging Quantity	15000
--------------------	-------

Packaging Method	Reel, Reel/Carton
------------------	-------------------

### Other

Terminals & Splices Comment	Single magnet wire only.
-----------------------------	--------------------------

## Product Compliance

[For compliance documentation, visit the product page on TE.com>](#)

EU RoHS Directive 2011/65/EU	Compliant
------------------------------	-----------

EU ELV Directive 2000/53/EC	Compliant
-----------------------------	-----------

China RoHS 2 Directive MIIT Order No 32, 2016	No Restricted Materials Above Threshold
---	---

EU REACH Regulation (EC) No. 1907/2006	Current ECHA Candidate List: JUNE 2023 (235) Candidate List Declared Against: JUNE 2023 (235) Does not contain REACH SVHC
--	---

Halogen Content	Low Halogen - Br, Cl, F, I < 900 ppm per homogenous material. Also BFR/CFR/PVC Free
-----------------	---







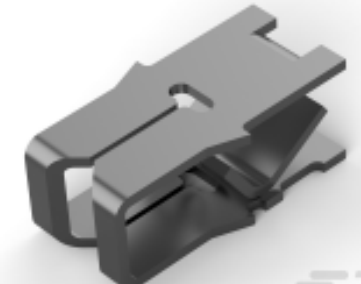

Solder Process Capability	Not applicable for solder process capability
---------------------------	--

#### Product Compliance Disclaimer

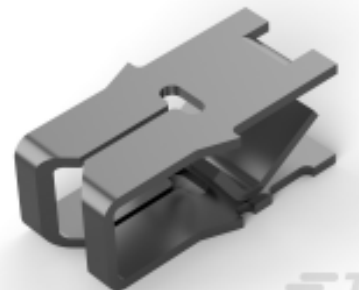

This information is provided based on reasonable inquiry of our suppliers and represents our current actual knowledge based on the information they provided. This information is subject to change. The part numbers that TE has identified as EU RoHS compliant have a maximum concentration of 0.1% by weight in homogenous materials for lead, hexavalent chromium, mercury, PBB, PBDE, DBP, BBP, DEHP, DIBP, and 0.01% for cadmium, or qualify for an exemption to these limits as defined in the Annexes of Directive 2011/65/EU (RoHS2). Finished electrical and electronic equipment products will be CE marked as required by Directive 2011/65/EU. Components may not be CE marked. Additionally, the part

numbers that TE has identified as EU ELV compliant have a maximum concentration of 0.1% by weight in homogenous materials for lead, hexavalent chromium, and mercury, and 0.01% for cadmium, or qualify for an exemption to these limits as defined in the Annexes of Directive 2000/53/EC (ELV). Regarding the REACH Regulation, the information TE provides on SVHC in articles for this part number is based on the latest European Chemicals Agency (ECHA) 'Guidance on requirements for substances in articles' posted at this URL: <https://echa.europa.eu/guidance-documents/guidance-on-reach>

## Compatible Parts

 <p>TE Part # 926852-2 MAG MATE LEAF KONT</p>	 <p>TE Part # 926851-2 MAG MATE LEAF KONT</p>	 <p>TE Part # 964337-2 CODE WIRE SIZE : 4</p>	 <p>TE Part # 926850-2 MAG MATE LEAF KONT</p>
 <p>TE Part # 926850-1 MAG MATE LEAF KONT</p>	 <p>TE Part # 1-928771-4 MAG-MATE LEAF TERMINAL</p>	 <p>TE Part # 926851-1 MAG MATE LEAF KONT</p>	 <p>TE Part # 1394759-2 MAG MATE CONT.MKII</p>
 <p>TE Part # 926852-1 MAG-MATE LEAF CONT.</p>	 <p>TE Part # 926852-4 MAG MATE LEAF KONT</p>	 <p>TE Part # 964340-2 MAG MATE KONT. MKII</p>	

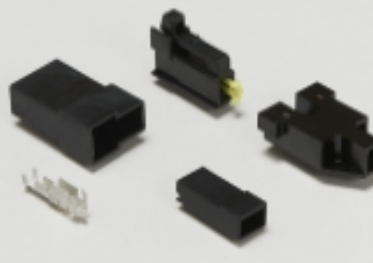
## Also in the Series | MAG-MATE

 <p>Insertion &amp; Extraction Tools(6)</p>	 <p>Magnet Wire Terminals(435)</p>	 <p>PCB Terminals(1)</p>
--	---	---

## Customers Also Bought

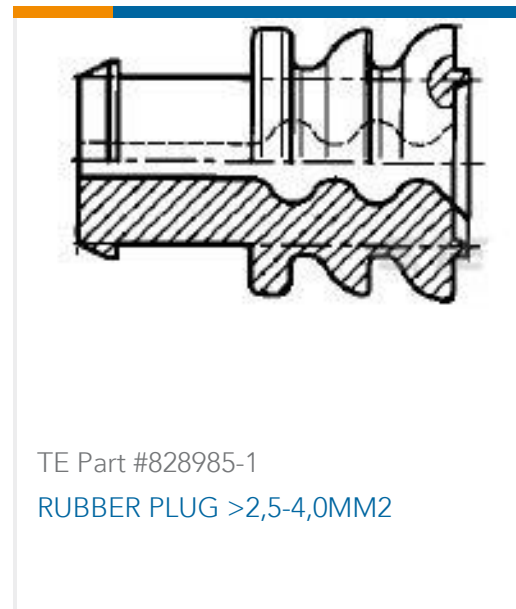
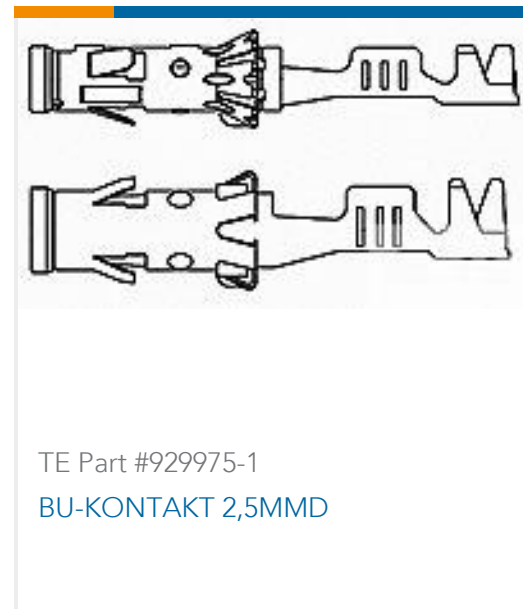
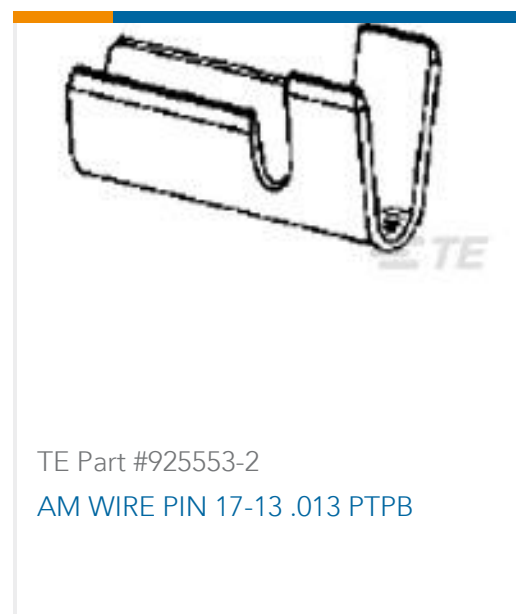

## Documents

### Product Drawings

#### MAG-MATE LEAF CONT.

English

### CAD Files

#### 3D PDF

3D

#### Customer View Model

[ENG\\_CVM\\_CVM\\_928770-2\\_C.2d\\_dxf.zip](#)

English

#### Customer View Model

[ENG\\_CVM\\_CVM\\_928770-2\\_C.3d\\_igs.zip](#)

English

#### Customer View Model

[ENG\\_CVM\\_CVM\\_928770-2\\_C.3d\\_stp.zip](#)

English

By downloading the CAD file I accept and agree to the [Terms and Conditions](#) of use.

### Datasheets & Catalog Pages



## Magnet Wire Terminals & Splices

English

---

## Product Specifications

### Application Specification

English

---

## Product Environmental Compliance

[MD\\_928770-2\\_11192014955\\_dmtec](#)

English

[MD\\_928770-2\\_11192014955\\_dmtec](#)

English