



Positive Lock | Positive Lock 250

TE Internal #: 927852-2

Quick Disconnects, Receptacle, 20 – 17 AWG Wire Size, .51 – 1.03 mm<sup>2</sup> Wire Size, Mating Tab Width 6.35 mm [.25 in], Straight, Brass, Positive Lock 250

[View on TE.com >](#)

Terminals & Splices > Quick Disconnects

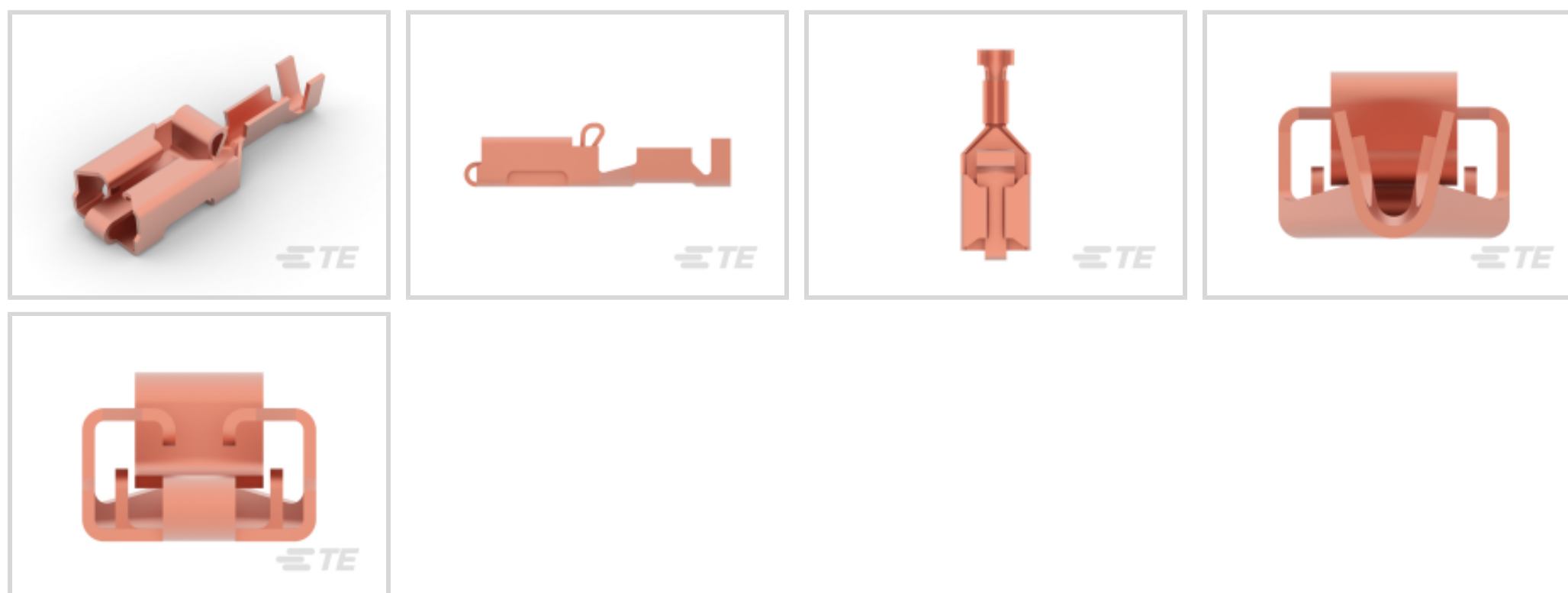

Quick Disconnect Terminal Type: **Receptacle**

Wire Size: .51 – 1.03 mm<sup>2</sup>

Mating Tab Width: 6.35 mm [.25 in]

Mating Tab Thickness: .81 mm [.032 in]

**Features**

**Product Type Features**

Insertion Force	Low
-----------------	-----

**Configuration Features**

Connection Capacity	Single
Compatible With Wire & Cable Type	FLK

**Contact Features**

Quick Disconnect Terminal Type	Receptacle
Mating Tab Width	6.35 mm [.25 in]
Mating Tab Thickness	.81 mm [.032 in]
Terminal Orientation	Straight
Contact Base Material	Brass
Terminal Plating Material	Unplated
Crimp Type	F-Crimp
Barrel Type	Open

**Termination Features**

--	--



Product Terminates To	Wire & Cable
-----------------------	--------------

### Mechanical Attachment

Extraction Force	7 – 100 Newton
------------------	----------------

Wire Insulation Support	With
-------------------------	------

Mating Retention Type	Dimple
-----------------------	--------

### Dimensions

Terminal Material Thickness	.41 mm[.016 in]
-----------------------------	-----------------

Product Length	22.3 mm[.878 in]
----------------	------------------

Compatible Insulation Diameter Range	1.4 – 2.31 mm[.055 – .091 in]
--------------------------------------	-------------------------------

Wire Size	.51 – 1.03 mm <sup>2</sup>
-----------	----------------------------

### Usage Conditions

Insulation Option	Uninsulated
-------------------	-------------

Operating Temperature Range	-40 – 110 °C[-40 – 230 °F]
-----------------------------	----------------------------

### Industry Standards

Agency/Standard	UL
-----------------	----

### Packaging Features

Packaging Quantity	4500
--------------------	------

Packaging Method	Strip/Reel
------------------	------------

### Other

Terminals & Splices Comment	FLKr-Wire: Thin Walled Wire
-----------------------------	-----------------------------

### Product Compliance

[For compliance documentation, visit the product page on TE.com>](#)

EU RoHS Directive 2011/65/EU	Compliant
------------------------------	-----------

EU ELV Directive 2000/53/EC	Compliant
-----------------------------	-----------

China RoHS 2 Directive MIIT Order No 32, 2016	No Restricted Materials Above Threshold
---	---

EU REACH Regulation (EC) No. 1907/2006	Current ECHA Candidate List: JUNE 2023 (235) Candidate List Declared Against: JUNE 2023 (235) Does not contain REACH SVHC
--	---

Halogen Content	Low Halogen - Br, Cl, F, I < 900 ppm per homogenous material. Also BFR/CFR/PVC Free
-----------------	---

Solder Process Capability

Not applicable for solder process capability

Product Compliance Disclaimer

This information is provided based on reasonable inquiry of our suppliers and represents our current actual knowledge based on the information they provided. This information is subject to change. The part numbers that TE has identified as EU RoHS compliant have a maximum concentration of 0.1% by weight in homogenous materials for lead, hexavalent chromium, mercury, PBB, PBDE, DBP, BBP, DEHP, DIBP, and 0.01% for cadmium, or qualify for an exemption to these limits as defined in the Annexes of Directive 2011/65/EU (RoHS2). Finished electrical and electronic equipment products will be CE marked as required by Directive 2011/65/EU. Components may not be CE marked. Additionally, the part numbers that TE has identified as EU ELV compliant have a maximum concentration of 0.1% by weight in homogenous materials for lead, hexavalent chromium, and mercury, and 0.01% for cadmium, or qualify for an exemption to these limits as defined in the Annexes of Directive 2000/53/EC (ELV). Regarding the REACH Regulation, the information TE provides on SVHC in articles for this part number is based on the latest European Chemicals Agency (ECHA) 'Guidance on requirements for substances in articles' posted at this URL: <https://echa.europa.eu/guidance-documents/guidance-on-reach>

### Compatible Parts



TE Part # 2305570-1  
Strip Terminal Cutter-Side Feed-No Crimp



TE Part # CAT-T4827-CH8172  
Timer Connector Housing



TE Part # 724659-2  
EXT TOOL FOR POSITIVE .250



TE Part # 1380088-1  
PL MKIII .250 REC 0.5-1.0MM2



TE Part # 2151161-2  
OCEAN\_2.0 APPLICATOR-S-081F1100VA



TE Part # 7-2151161-2  
OCEAN\_2.0 APPLICATOR-S-081F1100VA



TE Part # 7-2151161-7  
OCEAN\_2.0\_SPARE\_PART\_KIT-081F1100V



TE Part # 539743-2  
DIE F2.8FF TAB



TE Part # 2-2151161-2  
OCEAN\_2.0 APPLICATOR-S-081F1100VA



TE Part # 169400  
CERTI-LOK FRAME W/O DIES



TE Part # 734469  
MATRIZENPAAR



TE Part # 1-444017-1  
HSG ASSY TIMER 9P



## Also in the Series | Positive Lock 250

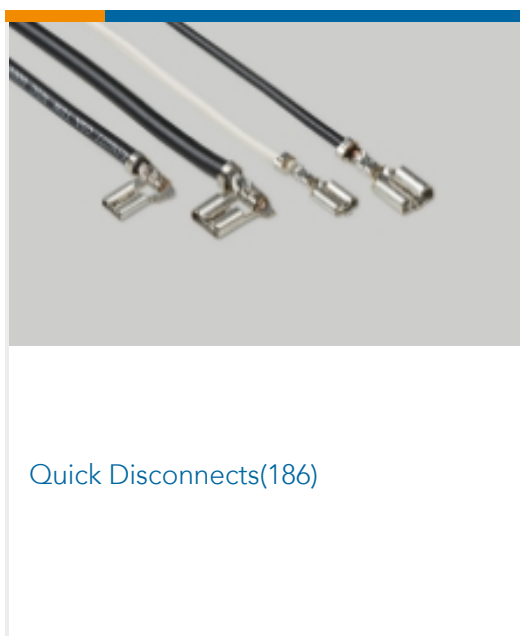
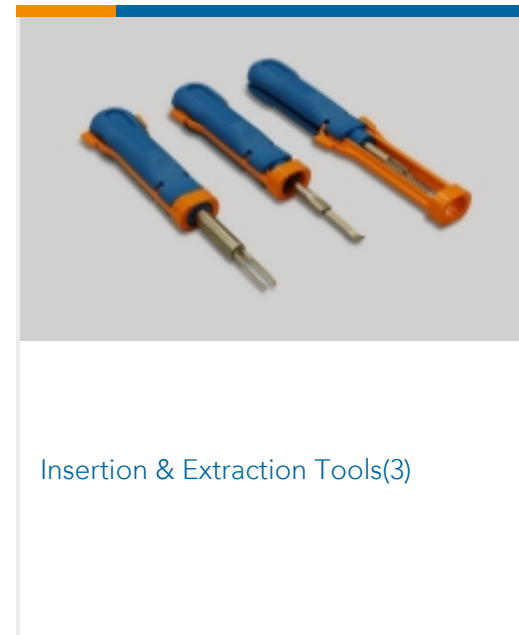
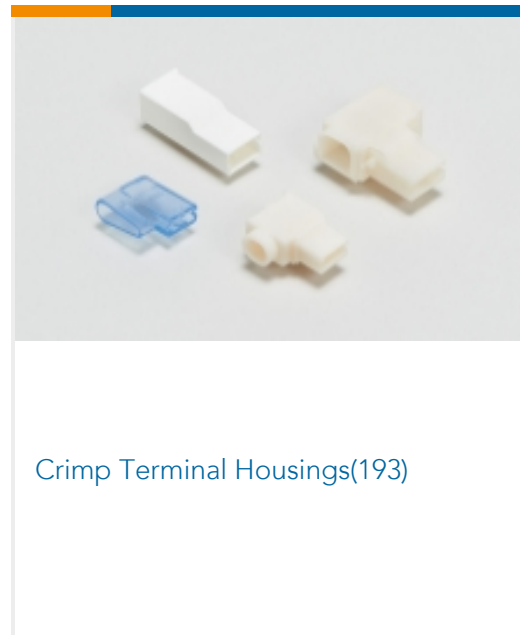
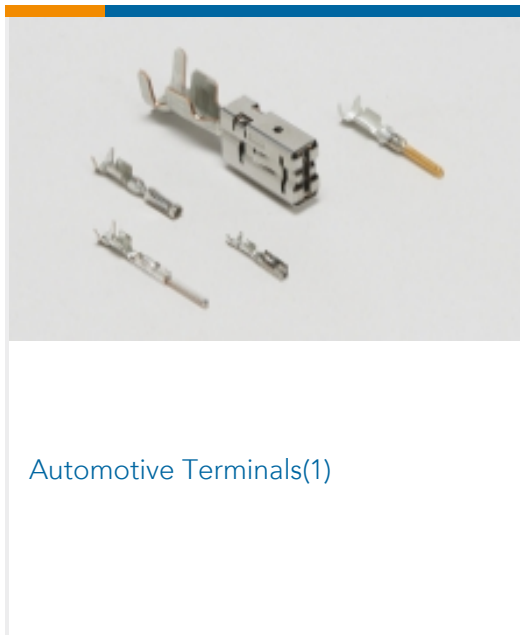

## Customers Also Bought

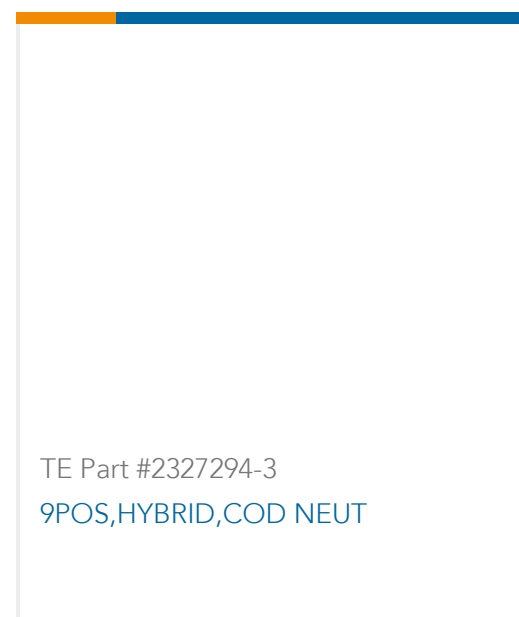
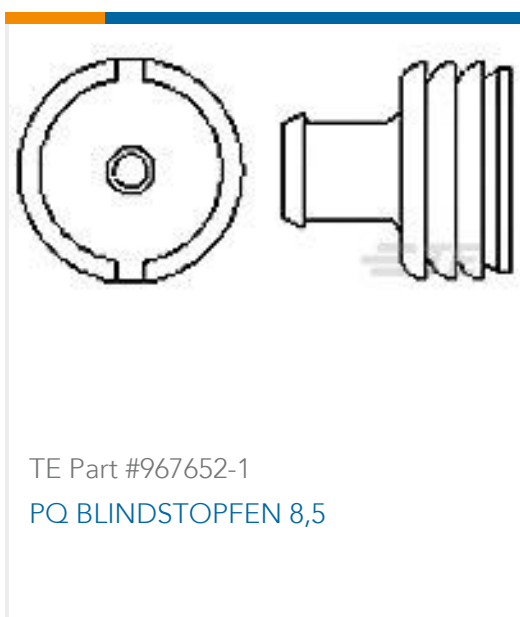





## Documents

### Product Drawings

[PL 250 REC TERMINAL 20-17 AWG PBR](#)

English

### CAD Files

[3D PDF](#)

3D

Customer View Model

[ENG\\_CVM\\_CVM\\_927852-2\\_G.2d\\_dxf.zip](#)

English

Customer View Model

[ENG\\_CVM\\_CVM\\_927852-2\\_G.3d\\_igs.zip](#)

English

Customer View Model

[ENG\\_CVM\\_CVM\\_927852-2\\_G.3d\\_stp.zip](#)

English

By downloading the CAD file I accept and agree to the [Terms and Conditions](#) of use.

### Datasheets & Catalog Pages

[1654742\\_HOUSEHOLD\\_APPLIANCES\\_RAST5](#)

English

### Product Specifications

[Application Specification](#)

German

[Application Specification](#)

English