



AMP | Standard Power Timer

TE Internal #: 927836-1

Automotive Terminals, Receptacle, Mating Tab Width 6.3 mm / 5.8 mm [.248 in / .228 in], Tab Thickness .8 mm [.031 in], Standard Power Timer

[View on TE.com >](#)

Terminals & Splices > Automotive Terminals > TIMER, RECEPTACLE AND TAB



Terminal Type: **Receptacle**

Mating Tab Width: 5.8 mm, 6.3 mm [.228 in, .248 in]

Mating Tab Thickness: .8 mm [.031 in]

Terminal Transmits: 25 – 40 A (Power)

Wire Size: 20 – 17 AWG

[All TIMER, RECEPTACLE AND TAB \(348\)](#)

Features

Product Type Features

Receptacle Style	180°
Sealable	Yes
Primary Locking Feature	Locking Lance

Body Features

Terminal Seal Type	Single Wire Seal (SWS)
--------------------	------------------------

Contact Features

Contact Size	6.3mm
Contact Fabrication	Stamped & Formed
Wire Contact Termination Area Plating Material	Tin
Typical Current Rating	40 A
Crimp Type	F-Crimp
Terminal Type	Receptacle
Mating Tab Width	5.8 mm, 6.3 mm [.228 in][.248 in]
Mating Tab Thickness	.8 mm [.031 in]
Interface Plating	Tin (Sn)

Termination Features



Termination Method to Wire & Cable	Crimp
Product Terminates To	Wire

Dimensions

Compatible Insulation Diameter Range	1.4 – 3 mm [.236 in]
Wire Size	.5 – 1 mm ²
Wire Size Search	17 AWG, 18 AWG, 19 AWG, 20 AWG

Usage Conditions

Insulation Option	Uninsulated
Operating Temperature (Max)	80 °C, 85 °C, 90 °C, 100 °C, 105 °C, 110 °C, 120 °C, 125 °C, 130 °C [176 °F][185 °F][194 °F][212 °F][221 °F][230 °F][248 °F][257 °F][266 °F]
Operating Temperature Range	-40 – 130 °C [-40 – 266 °F]

Operation/Application

Compatible With Wire Base Material	Copper
------------------------------------	--------

Industry Standards

Agency/Standard	IEC 664/664A (DIN VDE 0110)
-----------------	-----------------------------

Packaging Features

Packaging Quantity	1500
Packaging Method	Reel

Other

Terminal Transmits	25 – 40 A (Power)
--------------------	-------------------

Product Compliance

[For compliance documentation, visit the product page on TE.com>](#)

EU RoHS Directive 2011/65/EU	Compliant
EU ELV Directive 2000/53/EC	Compliant
China RoHS 2 Directive MIIT Order No 32, 2016	No Restricted Materials Above Threshold
EU REACH Regulation (EC) No. 1907/2006	Current ECHA Candidate List: JUNE 2023 (235) Candidate List Declared Against: JUNE 2022 (224) Does not contain REACH SVHC
Halogen Content	Low Halogen - Br, Cl, F, I < 900 ppm per homogenous material. Also BFR/CFR/PVC

Free

Solder Process Capability

Not applicable for solder process capability

Product Compliance Disclaimer

This information is provided based on reasonable inquiry of our suppliers and represents our current actual knowledge based on the information they provided. This information is subject to change. The part numbers that TE has identified as EU RoHS compliant have a maximum concentration of 0.1% by weight in homogenous materials for lead, hexavalent chromium, mercury, PBB, PBDE, DBP, BBP, DEHP, DIBP, and 0.01% for cadmium, or qualify for an exemption to these limits as defined in the Annexes of Directive 2011/65/EU (RoHS2). Finished electrical and electronic equipment products will be CE marked as required by Directive 2011/65/EU. Components may not be CE marked. Additionally, the part numbers that TE has identified as EU ELV compliant have a maximum concentration of 0.1% by weight in homogenous materials for lead, hexavalent chromium, and mercury, and 0.01% for cadmium, or qualify for an exemption to these limits as defined in the Annexes of Directive 2000/53/EC (ELV). Regarding the REACH Regulation, the information TE provides on SVHC in articles for this part number is based on the latest European Chemicals Agency (ECHA) 'Guidance on requirements for substances in articles' posted at this URL: <https://echa.europa.eu/guidance-documents/guidance-on-reach>

Compatible Parts

TE Part # 4-1579007-3
EXTRACTION TOOL KIT

TE Part # 1-1579007-6
EXTRACTION TOOL

TE Part # 963243-1
EINZELDRAHTDICHTUNG

TE Part # 963244-1
EINZELDRAHTDICHTUNG

TE Part # 2305570-1
Strip Terminal Cutter-Side Feed-No Crimp

TE Part # CAT-T4827-CH8172
Timer Connector Housing

TE Part # 2-962917-1
TAB 5.8x0.8 CONTACT CF SWS Sn

TE Part # 2151159-1
OCEAN_2.0_APPLICATOR-S-080F2500

TE Part # 2151159-2
OCEAN_2.0_APPLICATOR-S-080F2500

TE Part # 7-2151159-1
OCEAN_2.0_APPLICATOR-S-080F2500

TE Part # 7-2151159-2
OCEAN_2.0_APPLICATOR-S-080F2500

TE Part # 7-2151159-7
OCEAN_2.0_SPARE_PART_KIT-080F2500



Also in the Series | Standard Power Timer

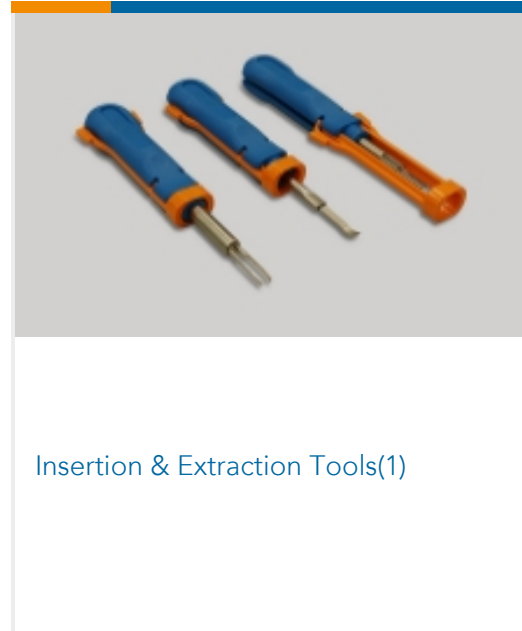
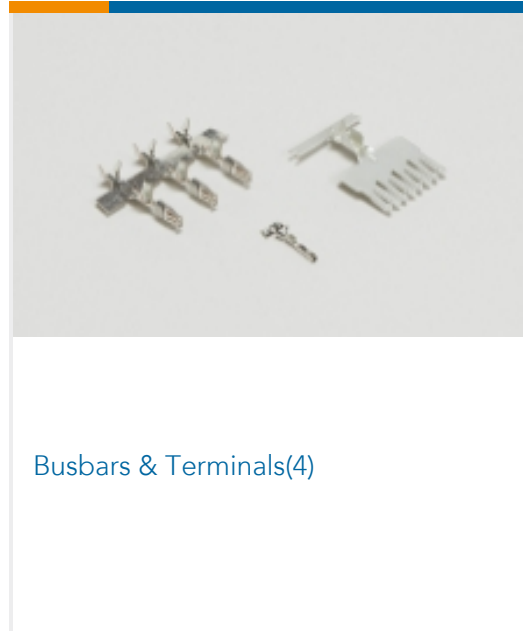
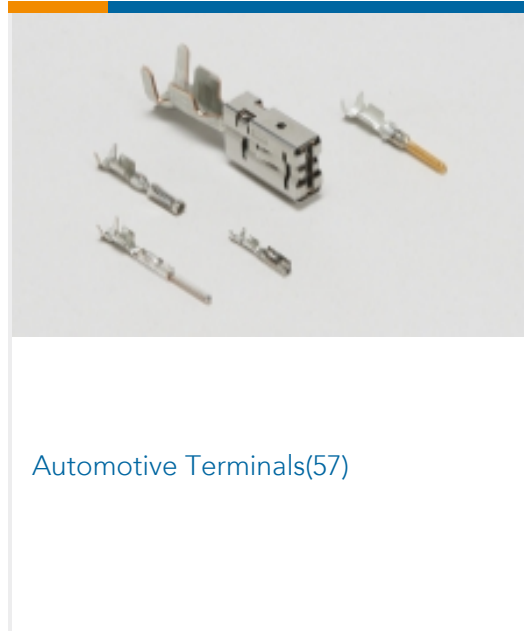
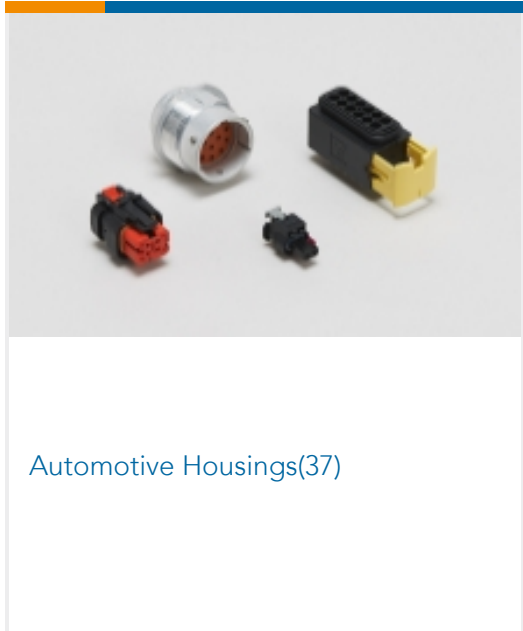

Customers Also Bought

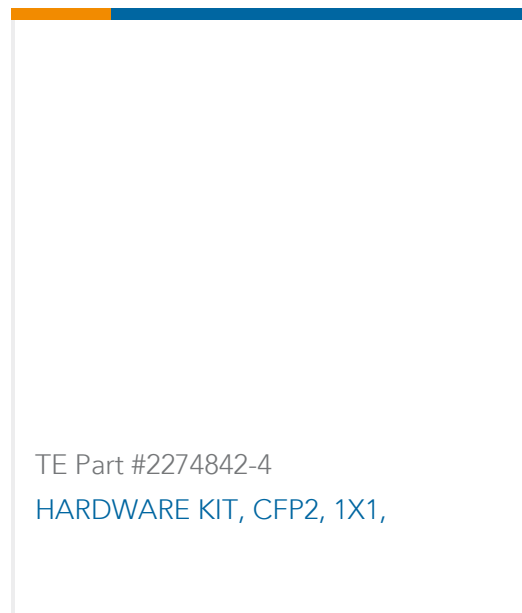
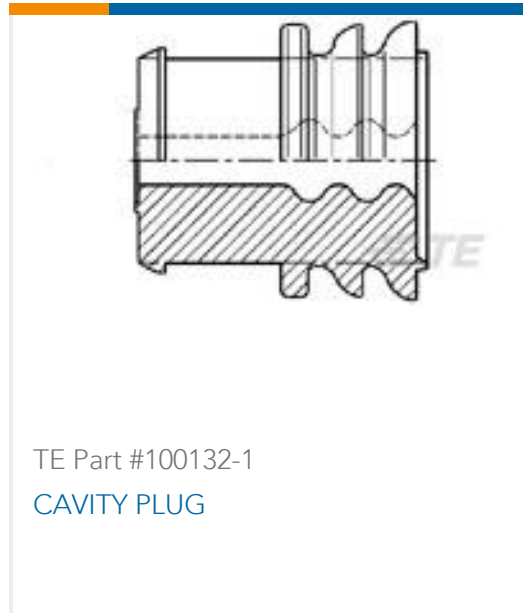
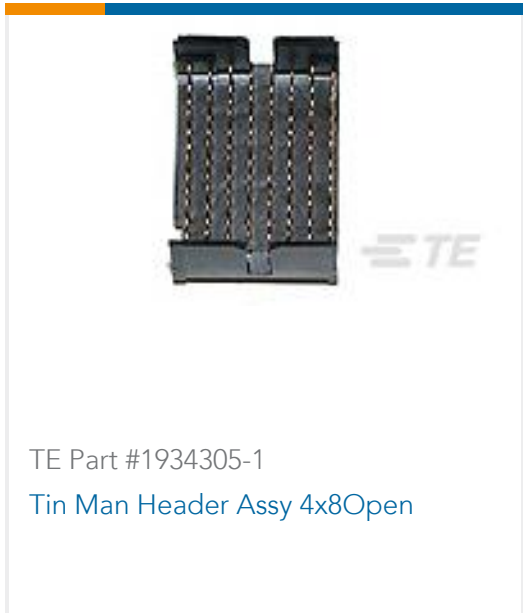

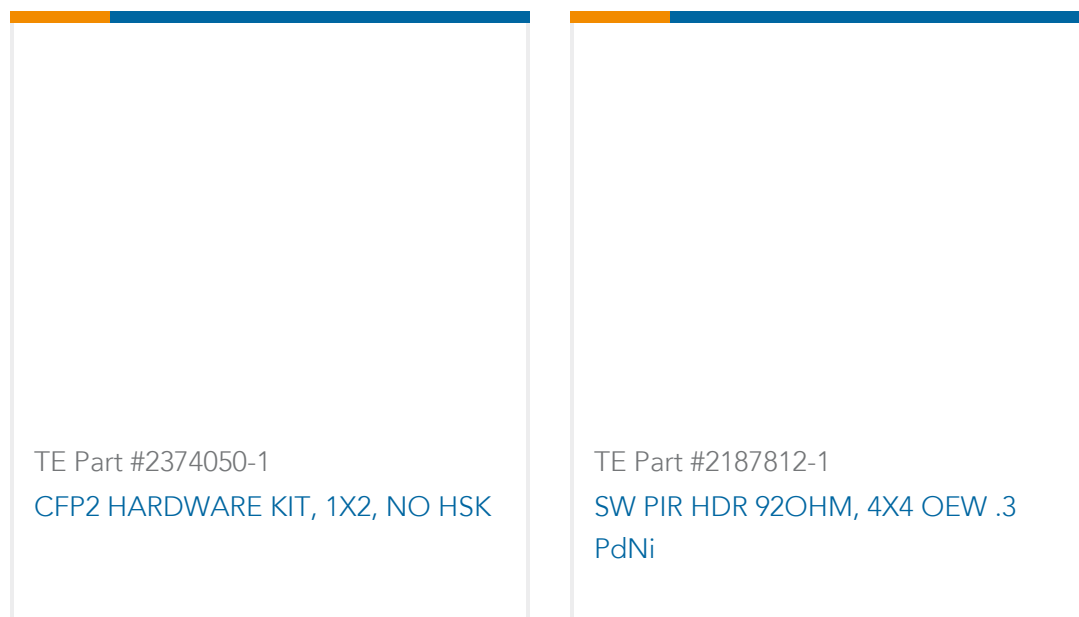

Documents

Product Drawings

[SPT REC 6.3 Contact SWS Sn](#)

English

CAD Files

Customer View Model

[ENG_CVM_CVM_927836-1_C.2d_dxf.zip](#)

English

[3D PDF](#)

3D

Customer View Model

[ENG_CVM_CVM_927836-1_C.3d_igs.zip](#)

English

Customer View Model

[ENG_CVM_CVM_927836-1_C.3d_stp.zip](#)

English

By downloading the CAD file I accept and agree to the [Terms and Conditions](#) of use.

Datasheets & Catalog Pages

[Timer Interconnection System](#)

English

Product Specifications

[Application Specification](#)

German

[Application Specification](#)

English

[Application Specification](#)

English