



AMP | Standard Power Timer

TE Internal #: 927824-1

Automotive Terminals, Receptacle, 13 – 11 AWG Wire Size, 2.5 – 4 mm<sup>2</sup> Wire Size, Tin (Sn) Interface Plating, Terminates To Wire, Standard Power Timer

[View on TE.com >](#)

Terminals & Splices > Automotive Terminals > TIMER, RECEPTACLE AND TAB



Terminal Type: **Receptacle**

Terminal Transmits: **25 – 40 A (Power)**

Wire Size: **2.5 – 4 mm<sup>2</sup>**

Sealable: **No**

[All TIMER, RECEPTACLE AND TAB \(348\)](#)

### Features

#### Product Type Features

Receptacle Style	180°
Sealable	No
Primary Locking Feature	Locking Lance

#### Contact Features

Contact Size	6.3mm
Contact Fabrication	Stamped & Formed
Wire Contact Termination Area Plating Material	Tin
Typical Current Rating	40 A
Crimp Type	F-Crimp
Terminal Type	Receptacle
Interface Plating	Tin (Sn)

#### Termination Features

Termination Method to Wire & Cable	Crimp
Product Terminates To	Wire

#### Dimensions

Compatible Insulation Diameter Range	3.3 – 4.5 mm [.129 – .177 in]
Wire Size	2.5 – 4 mm <sup>2</sup>



Wire Size Search	11 AWG, 12 AWG, 13 AWG
------------------	------------------------

### Usage Conditions

Insulation Option	Uninsulated
Operating Temperature (Max)	80 °C, 85 °C, 90 °C, 100 °C, 105 °C, 110 °C, 120 °C, 125 °C, 130 °C [176 °F][185 °F][194 °F][212 °F][221 °F][230 °F][248 °F][257 °F][266 °F]
Operating Temperature Range	-40 – 130 °C [-40 – 266 °F]

### Operation/Application

Compatible With Wire Base Material	Copper
------------------------------------	--------

### Industry Standards

Agency/Standard	IEC 664/664A (DIN VDE 0110)
-----------------	-----------------------------

### Packaging Features

Packaging Quantity	2000
Packaging Method	Reel

### Other

Terminal Transmits	25 – 40 A (Power)
--------------------	-------------------

## Product Compliance

[For compliance documentation, visit the product page on TE.com>](#)

EU RoHS Directive 2011/65/EU	Compliant
EU ELV Directive 2000/53/EC	Compliant
China RoHS 2 Directive MIIT Order No 32, 2016	No Restricted Materials Above Threshold
EU REACH Regulation (EC) No. 1907/2006	Current ECHA Candidate List: JUNE 2023 (235) Candidate List Declared Against: JUNE 2023 (235) Does not contain REACH SVHC
Halogen Content	Low Halogen - Br, Cl, F, I < 900 ppm per homogenous material. Also BFR/CFR/PVC Free
Solder Process Capability	Not applicable for solder process capability

#### Product Compliance Disclaimer

This information is provided based on reasonable inquiry of our suppliers and represents our current actual knowledge based on the information they provided. This information is subject to change. The part numbers that TE has identified as EU RoHS compliant have a maximum concentration of 0.1% by weight in homogenous materials for lead, hexavalent chromium, mercury, PBB, PBDE, DBP, BBP, DEHP, DIBP, and 0.01% for cadmium, or qualify for an exemption to these

limits as defined in the Annexes of Directive 2011/65/EU (RoHS2). Finished electrical and electronic equipment products will be CE marked as required by Directive 2011/65/EU. Components may not be CE marked. Additionally, the part numbers that TE has identified as EU ELV compliant have a maximum concentration of 0.1% by weight in homogenous materials for lead, hexavalent chromium, and mercury, and 0.01% for cadmium, or qualify for an exemption to these limits as defined in the Annexes of Directive 2000/53/EC (ELV). Regarding the REACH Regulation, the information TE provides on SVHC in articles for this part number is based on the latest European Chemicals Agency (ECHA) 'Guidance on requirements for substances in articles' posted at this URL: <https://echa.europa.eu/guidance-documents/guidance-on-reach>

## Compatible Parts



TE Part # 4-1579007-3  
EXTRACTION TOOL KIT



TE Part # 1-1579007-6  
EXTRACTION TOOL



TE Part # 2305570-1  
Strip Terminal Cutter-Side Feed-No Crimp



TE Part # CAT-M9194-CH8172  
MULTILOCK, CONNECTOR HOUSING



TE Part # CAT-T4827-CH8172  
Timer Connector Housing



TE Part # 962910-2  
TAB AS 4.8x0.8 CONTACT CF SWS Sn



TE Part # 2-2266061-1  
OC-PA-S-FM-130F180OV-001-0254



TE Part # 2-2266061-2  
OC-PA-S-FA-130F180OV-001-0254



TE Part # 2151262-1  
OCEAN\_2\_0\_Applicator-S-130F180F



TE Part # 2151262-2  
OCEAN\_2\_0\_Applicator-S-130F180F



TE Part # 2266061-1  
OC-AT-S-FM-130F180OV-001-0254



TE Part # 2266061-2  
OC-AT-S-FA-130F180OV-001-0254



TE Part # 7-2151262-1  
OCEAN\_2\_0\_Applicator-S-130F180F



TE Part # 7-2151262-2  
OCEAN\_2\_0\_Applicator-S-130F180F



KIT  
TE Part # 7-2151262-7  
OC-130F180F-CRIMP TOOLING KIT



KIT  
TE Part # 7-2266061-7  
OC-130F180OV-CRIMP TOOLING KIT

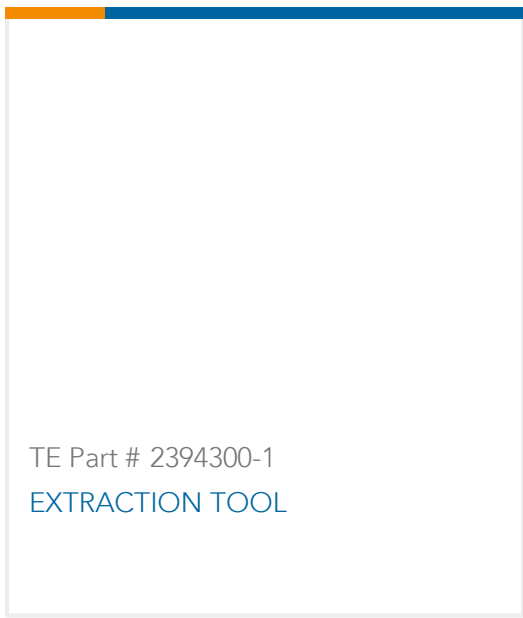

TE Part # 2394300-1  
EXTRACTION TOOL

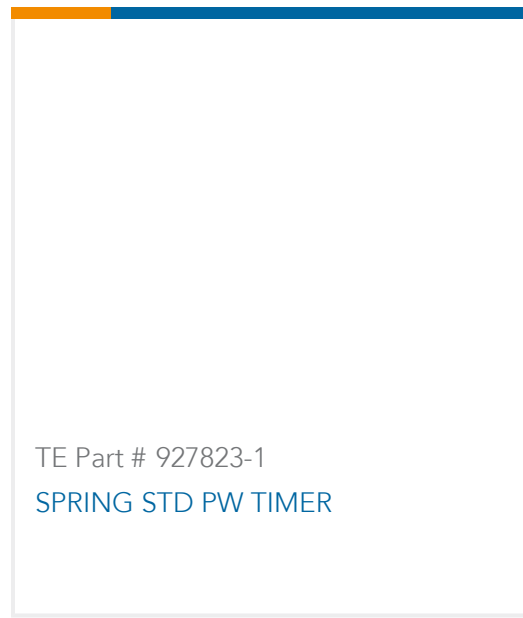

TE Part # 927823-1  
SPRING STD PW TIMER



TE Part # 2-2266062-1  
OC-PA-S-FM-130F160OV-001-0254



TE Part # 2-2266062-2  
OC-PA-S-FA-130F160OV-001-0254

## Also in the Series | Standard Power Timer

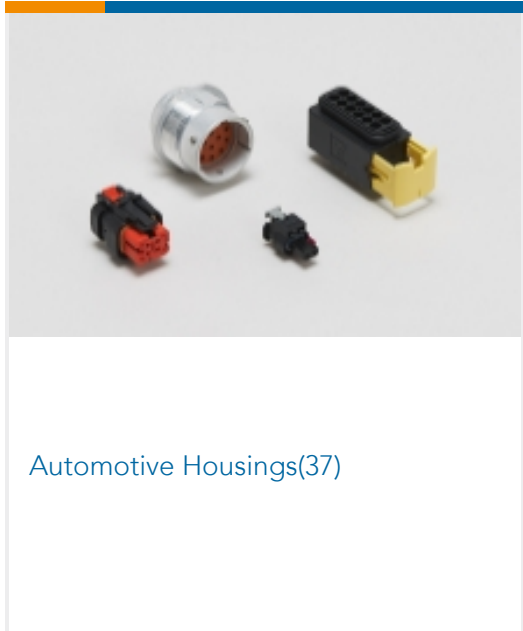

Automotive Housings(37)

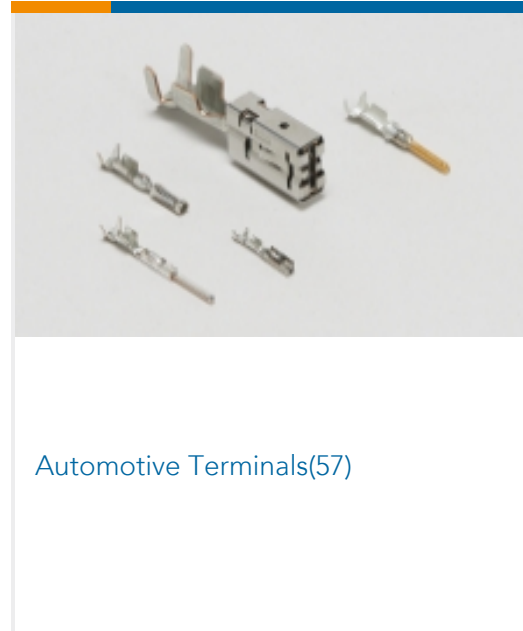

Automotive Terminals(57)

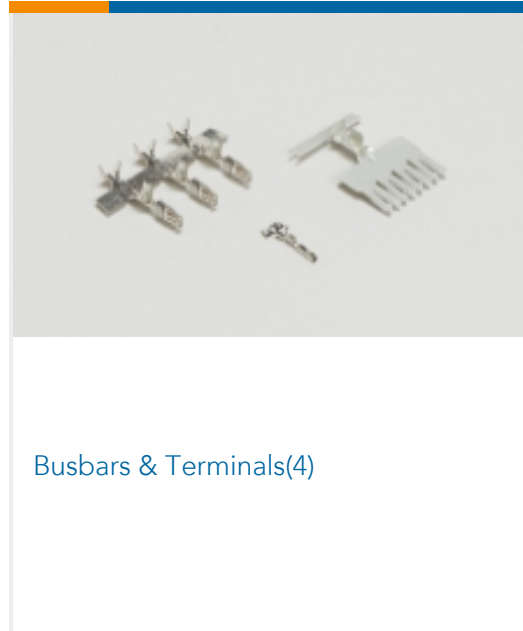

Busbars & Terminals(4)

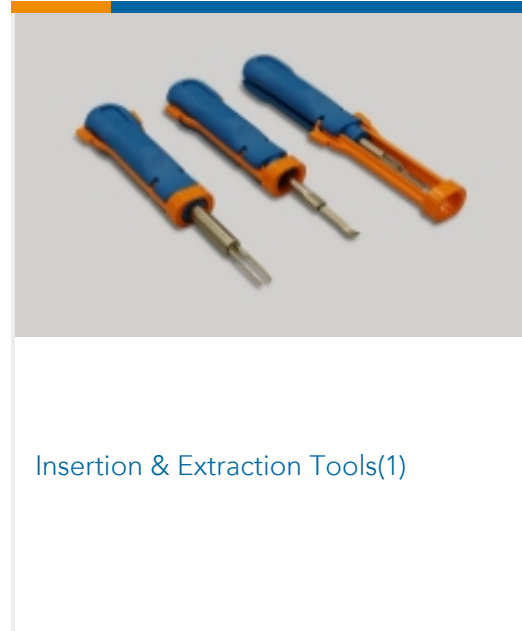

Insertion & Extraction Tools(1)



Module Components(6)

## Customers Also Bought



TE Part #936227-1  
MULTILOCK, CONNECTOR HOUSING



TE Part #927839-1  
TIMER, RECEPTACLE AND TAB



TE Part #967543-2  
AMP MCP, SFC, RECEPTACLE



TE Part #1955425-2  
187 FASTON,TAB,TPPB

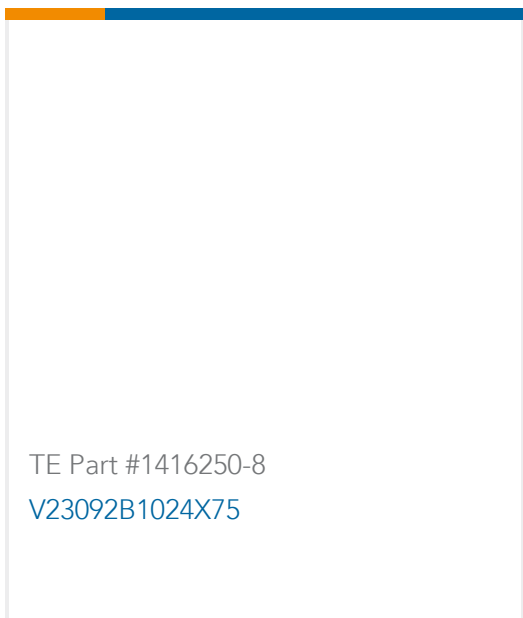

TE Part #1416250-8  
V23092B1024X75

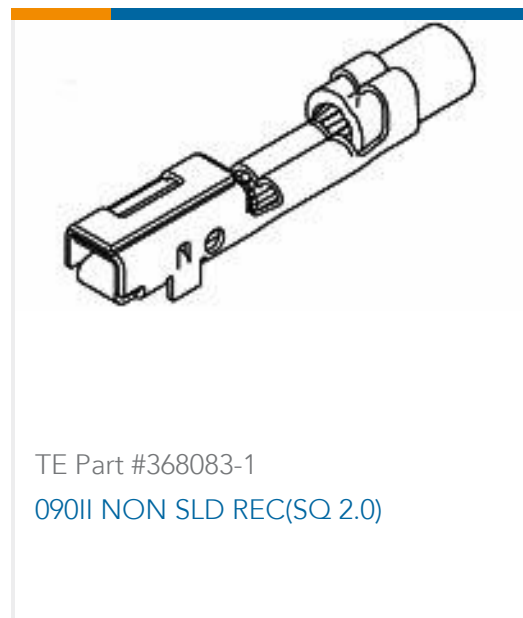

TE Part #368083-1  
090II NON SLD REC(SQ 2.0)



## Documents

### Product Drawings

[SPT REC 6.3 Contact SRC Sn](#)

English

---

### CAD Files

Customer View Model

[ENG\\_CVM\\_CVM\\_927824-1\\_C.2d\\_dxf.zip](#)

English

3D PDF

3D

Customer View Model

[ENG\\_CVM\\_CVM\\_927824-1\\_C.3d\\_igs.zip](#)

English

Customer View Model

[ENG\\_CVM\\_CVM\\_927824-1\\_C.3d\\_stp.zip](#)

English

By downloading the CAD file I accept and agree to the [Terms and Conditions](#) of use.

---

### Datasheets & Catalog Pages

[Timer Interconnection System](#)

English

---

### Product Specifications

[Application Specification](#)

German

[Application Specification](#)

English

[Application Specification](#)

English

---

### Product Environmental Compliance

[Product Compliance](#)

English

[Product Compliance](#)

English