



Terminals & Splices > Terminal Housings, Insulation Sleeves & Blocks > Crimp Terminal Housings



Terminal Type: **Tab**

Connector & Housing Type: **Tab Housing**

Number of Positions: **2**

Terminal Orientation: **Straight**

UL Flammability Rating: **UL 94V-2**

Features

Product Type Features

Sealable	No
Connector & Housing Type	Tab Housing

Configuration Features

Number of Positions	2
---------------------	---

Body Features

Connector & Keying Code	C
Primary Product Color	Natural

Contact Features

Terminal Type	Tab
Terminal Orientation	Straight
Contact Mating Retention	With

Mechanical Attachment

Mating Alignment Type	Polarization
-----------------------	--------------



Mating Retention Type	Locking Lance
-----------------------	---------------

Mating Alignment	With
------------------	------

Connector Mounting Type	Panel Mount
-------------------------	-------------

Housing Features

Housing Material	Polyamide
------------------	-----------

Centerline (Pitch)	5 mm [.196 in]
--------------------	----------------

Dimensions

Product Length	30.5 mm
----------------	---------

Usage Conditions

Operating Temperature Range	-40 – 105 °C [-40 – 221 °F]
-----------------------------	-----------------------------

Industry Standards

UL Flammability Rating	UL 94V-2
------------------------	----------

Packaging Features

Packaging Quantity	200
--------------------	-----

Product Compliance

[For compliance documentation, visit the product page on TE.com>](#)

EU RoHS Directive 2011/65/EU	Compliant
------------------------------	-----------

EU ELV Directive 2000/53/EC	Compliant
-----------------------------	-----------

China RoHS 2 Directive MIIT Order No 32, 2016	No Restricted Materials Above Threshold
---	---

EU REACH Regulation (EC) No. 1907/2006	Current ECHA Candidate List: JUNE 2023 (235) Candidate List Declared Against: JUNE 2023 (235) Does not contain REACH SVHC
--	---

Halogen Content	Low Halogen - Br, Cl, F, I < 900 ppm per homogenous material. Also BFR/CFR/PVC Free
-----------------	---

Solder Process Capability	Not applicable for solder process capability
---------------------------	--

Product Compliance Disclaimer

This information is provided based on reasonable inquiry of our suppliers and represents our current actual knowledge based on the information they provided. This information is subject to change. The part numbers that TE has identified as EU RoHS compliant have a maximum concentration of 0.1% by weight in homogenous materials for lead, hexavalent chromium, mercury, PBB, PBDE, DBP, BBP, DEHP, DIBP, and 0.01% for cadmium, or qualify for an exemption to these limits as defined in the Annexes of Directive 2011/65/EU (RoHS2). Finished electrical and electronic equipment products will be CE marked as required by Directive 2011/65/EU. Components may not be CE marked. Additionally, the part numbers that TE has identified as EU ELV compliant have a maximum concentration of 0.1% by weight in homogenous materials for lead, hexavalent chromium, and mercury, and 0.01% for cadmium, or qualify for an exemption to these limits

as defined in the Annexes of Directive 2000/53/EC (ELV). Regarding the REACH Regulation, the information TE provides on SVHC in articles for this part number is based on the latest European Chemicals Agency (ECHA) 'Guidance on requirements for substances in articles' posted at this URL: <https://echa.europa.eu/guidance-documents/guidance-on-reach>

Compatible Parts



TE Part # 9-927742-2
2POS FASTIN FASTON HOUSING



TE Part # 964492-2
2 POS FASTIN/ON HOUSING PANEL MOUNT



TE Part # 1241857-5
5 POS FASTIN/ON HOUSING PANEL MOUNT



TE Part # 5-293035-2
2 POS. FASTIN-FASTON CONN. TAB HOUSING R



TE Part # 9-927742-4
4POS FASTIN FASTON HOUSING



TE Part # 293011-1
5 POS. FASTIN-FASTON CONN. TAB HOUSING R



TE Part # 7-927742-6
6 POS. FASTIN-FASTON* TAB HSG RAST5



TE Part # 927742-4
4 POS FASTIN/ON HOUSING PANEL MOUNT



TE Part # 293161-1
5 POS. FASTIN-FASTON* TAB HSG, RAST5



TE Part # 9-1241857-5
5POS. FASTIN-FASTON* TAB HSG, RAST5



TE Part # 927742-5
5 POS FASTIN/ON HOUSING PANEL



TE Part # 928230-3
3 POS FASTIN/ON HOUSING PANEL MOUNT

Also in the Series | RAST 5 IDC Connectors

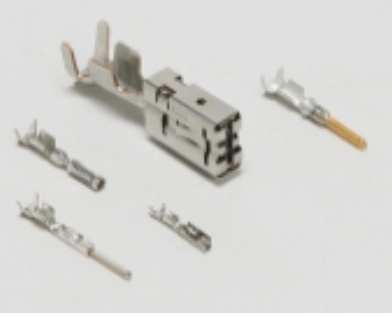

Automotive Terminals(8)



Connector Contacts(12)



Crimp Terminal Housings(41)



Insertion & Extraction Tools(1)



PCB Headers & Receptacles(417)



Rectangular Connector Housings(1)

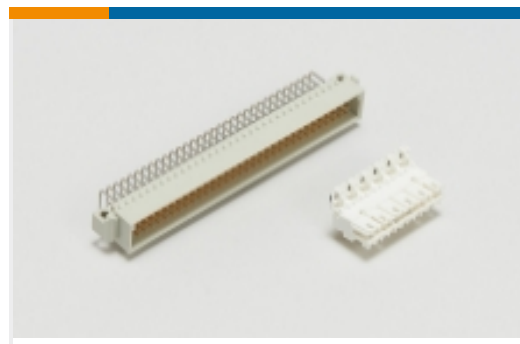

Standard Edge Connectors(34)



Standard Rectangular Connectors(68)



Wire-to-Board Connector Assemblies & Housings(214)



Wire-to-Board Connector Contacts(2)

Customers Also Bought



TE Part #934922-000
RMW-75/22-1200/ADH-0

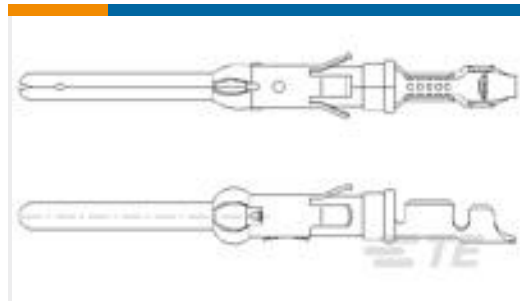

TE Part #163085-9
.062 DIA PIN ASS 3+

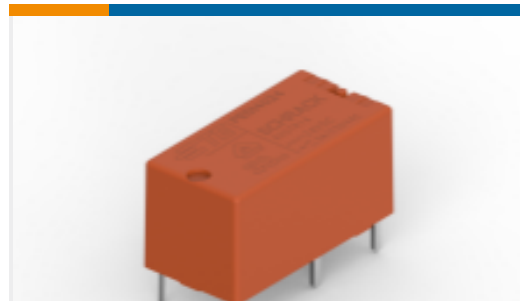

TE Part #2-1393219-2
PE514024



TE Part #9-927742-2
2POS FASTIN FASTON HOUSING

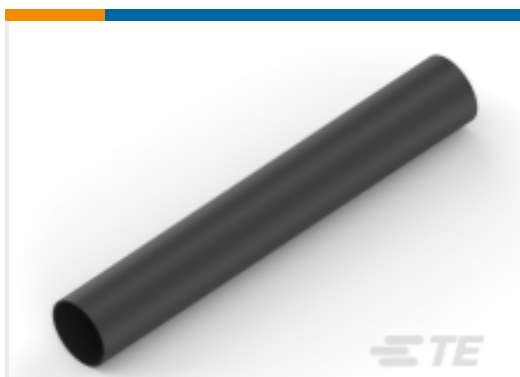

TE Part #NB07744001
HTAT-24/6-0-SP



TE Part #160134-2
RING TONGUE WITH IS 12-10 AWG
TPBR



TE Part #293009-1
4 POS. FASTIN-FASTON CONN. TAB
HOUSING R

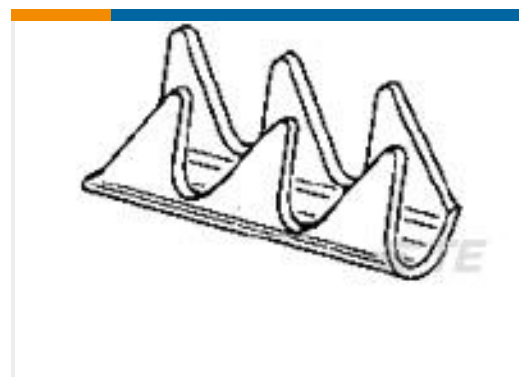

TE Part #925856-1
WIRE PIN 15.5-13.5 AWG .01 PTPB



TE Part #5-1618388-9
LEV200A6NAF=RELAY, SPST-NO



TE Part #2-2178029-5
STD TIMER GEH 5P_V0

Documents



CAD Files

3D PDF

3D

Customer View Model

[ENG_CVM_CVM_927742-2_G.2d_dxf.zip](#)

English

Customer View Model

[ENG_CVM_CVM_927742-2_G.3d_igs.zip](#)

English

Customer View Model

[ENG_CVM_CVM_927742-2_G.3d_stp.zip](#)

English

By downloading the CAD file I accept and agree to the [Terms and Conditions](#) of use.

Datasheets & Catalog Pages

[FASTIN_FASTON_Product_Line](#)

English

Product Specifications

[Product Specification](#)

English

Product Environmental Compliance

[MD_927742-2_11042015234_dmtec](#)

English

[MD_927742-2_11042015234_dmtec](#)

English

Agency Approvals

[VDE Certificate](#)

English

[VDE Certificate](#)

English