



Connectors > Power Connectors > Power Contacts



Power Contact Type: **Contact**

Operating Voltage: **600 VAC**

Contact Mating Area Plating Material: **Tin**

Wire Size: **.2 – .8 mm²**

Features

Product Type Features

Compatible With Discrete Wire Type	Stranded
Power Contact Type	Contact
Connector & Contact Terminates To	Wire & Cable

Electrical Characteristics

Operating Voltage	600 VAC
-------------------	---------

Contact Features

Contact Mating Area Plating Material	Tin
Contact Current Rating (Max)	19 A
Contact Type	Pin
Contact Retention Within Housing	With
Mating Pin Diameter	1.91 mm [.075 in]
Contact Base Material	Phosphor Bronze
Wire Contact Termination Area Plating Material	Pre-Tin
Wire Contact Termination Area Plating Material Finish	Bright
Contact Orientation	Straight



Termination Features

Termination Method to Wire & Cable	Crimp
------------------------------------	-------

Mechanical Attachment

Contact Retention Type Within Housing	Locking Lance
Wire Insulation Support	Without

Dimensions

Wire Size	.2 – .8 mm ²
Compatible Insulation Diameter Range	1 – 2.5 mm [.039 – .098 in]

Usage Conditions

Operating Temperature Range	-55 – 105 °C [-67 – 221 °F]
-----------------------------	-----------------------------

Operation/Application

Circuit Application	Power
---------------------	-------

Industry Standards

CSA Rating	Certified, LR 16455
UL Rating	Recognized
Agency/Standard	CSA, UL, VDE

Packaging Features

Packaging Quantity	6000
Packaging Method	Reel

Product Compliance

[For compliance documentation, visit the product page on TE.com>](#)

EU RoHS Directive 2011/65/EU	Compliant
EU ELV Directive 2000/53/EC	Compliant
China RoHS 2 Directive MIIT Order No 32, 2016	No Restricted Materials Above Threshold
EU REACH Regulation (EC) No. 1907/2006	Current ECHA Candidate List: JUNE 2023 (235) Candidate List Declared Against: JUNE 2023 (235) Does not contain REACH SVHC
Halogen Content	Low Halogen - Br, Cl, F, I < 900 ppm per homogenous material. Also BFR/CFR/PVC Free
Solder Process Capability	Not applicable for solder process capability

Product Compliance Disclaimer

This information is provided based on reasonable inquiry of our suppliers and represents our current actual knowledge based on the information they provided. This information is subject to change. The part numbers that TE has identified as EU RoHS compliant have a maximum concentration of 0.1% by weight in homogenous materials for lead, hexavalent chromium, mercury, PBB, PBDE, DBP, BBP, DEHP, DIBP, and 0.01% for cadmium, or qualify for an exemption to these limits as defined in the Annexes of Directive 2011/65/EU (RoHS2). Finished electrical and electronic equipment products will be CE marked as required by Directive 2011/65/EU. Components may not be CE marked. Additionally, the part numbers that TE has identified as EU ELV compliant have a maximum concentration of 0.1% by weight in homogenous materials for lead, hexavalent chromium, and mercury, and 0.01% for cadmium, or qualify for an exemption to these limits as defined in the Annexes of Directive 2000/53/EC (ELV). Regarding the REACH Regulation, the information TE provides on SVHC in articles for this part number is based on the latest European Chemicals Agency (ECHA) 'Guidance on requirements for substances in articles' posted at this URL: <https://echa.europa.eu/guidance-documents/guidance-on-reach>

Compatible Parts

 <p>TE Part # 455830-1 INSERTION TOOL</p>	 <p>TE Part # 1-480705-2 06P UNML CAP HSG RED</p>	 <p>TE Part # 1-480708-9 12P UMNL PLUG HSG BLK</p>	 <p>TE Part # 350784-1 15P UMNL CAP HSG</p>
 <p>TE Part # 926307-3 6P UN-MNL AUFN-GEH</p>	 <p>TE Part # 1-480704-2 06P UMNL PLUG HSG RED</p>	 <p>TE Part # 926302-1 10& UNIV.M-N-L.PLUG</p>	 <p>TE Part # 1-350777-2 02P UMNL V0 PLUG HSG RED</p>
 <p>TE Part # 350783-1 12P UMNL CAP HSG</p>	 <p>TE Part # 1-350778-9 02P UMNL V0 CAP HSG BLACK</p>	 <p>TE Part # 350735-1 12P UMNL PLUG HSG</p>	 <p>TE Part # 926302-3 10P UN-MNL STECKGEH</p>



Also in the Series | **Universal MATE-N-LOK**

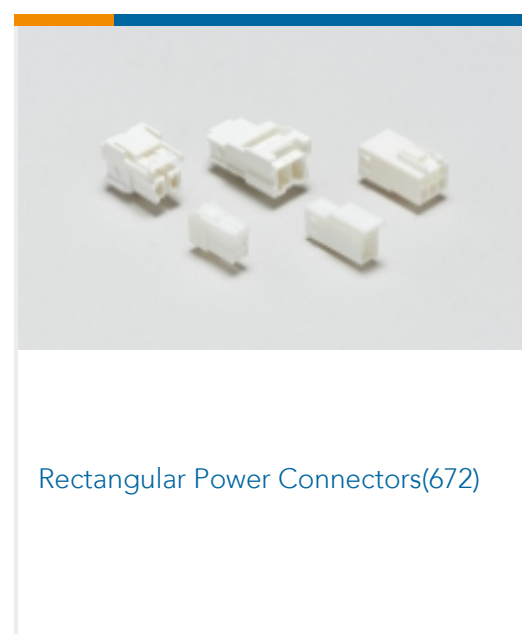
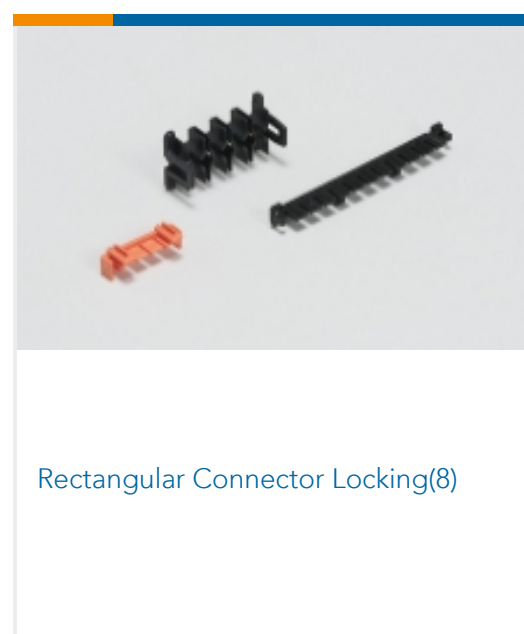
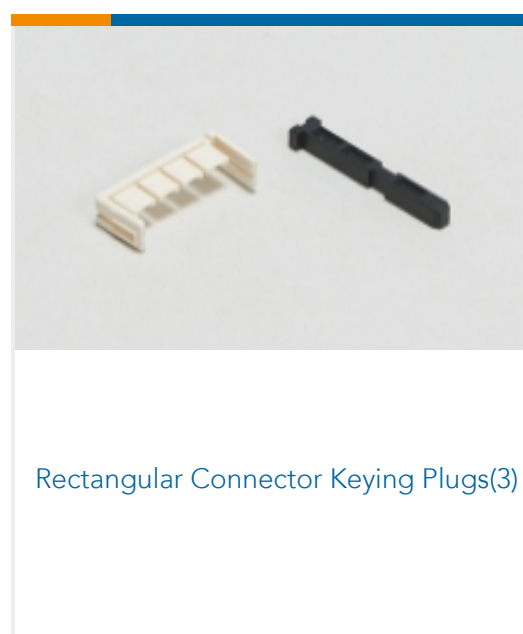
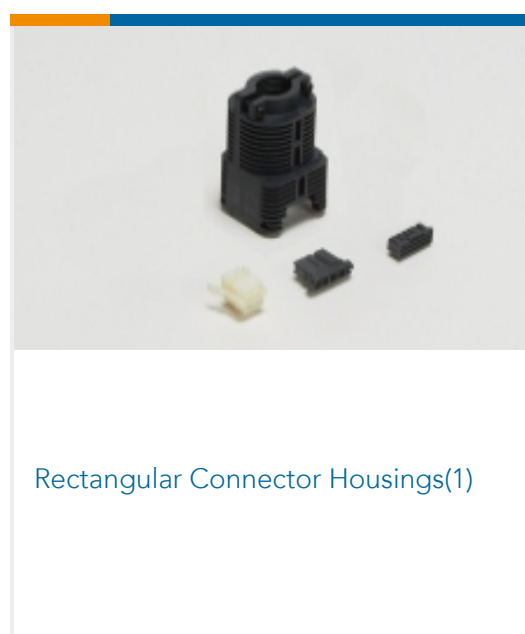
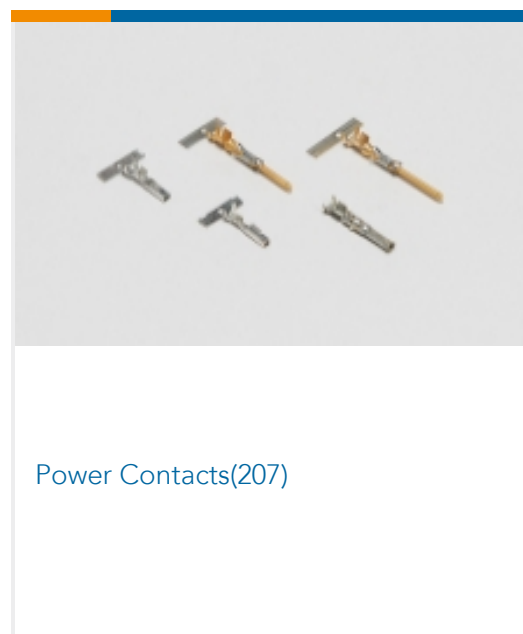
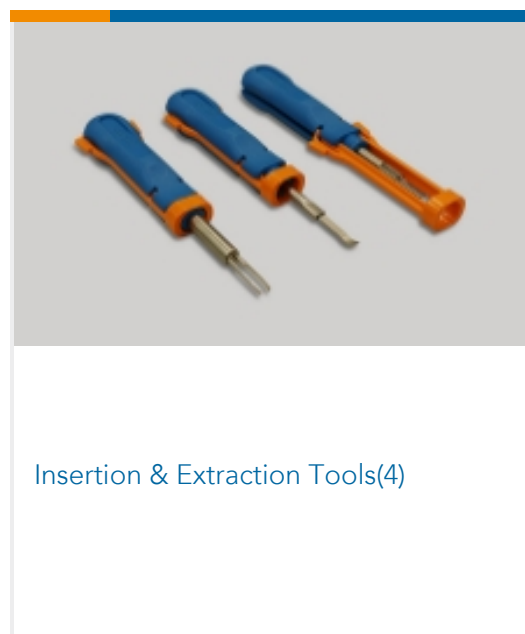
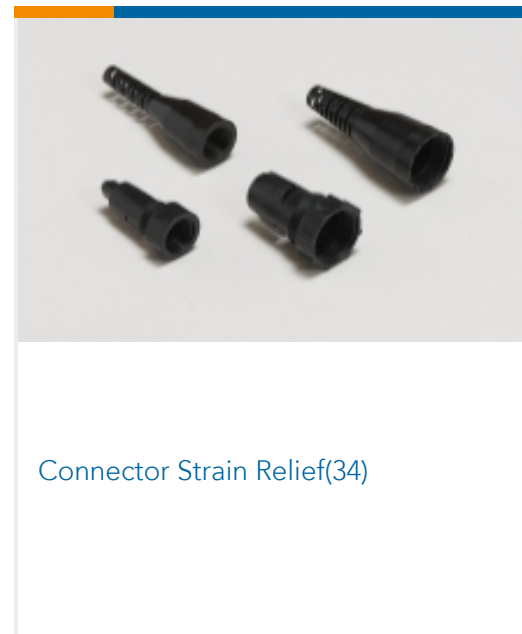
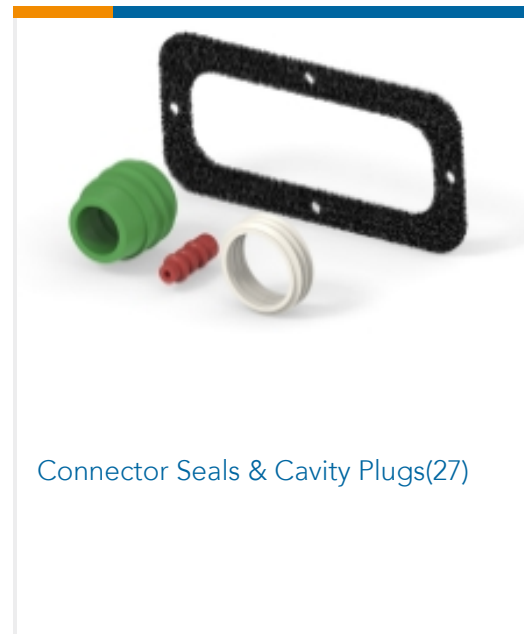
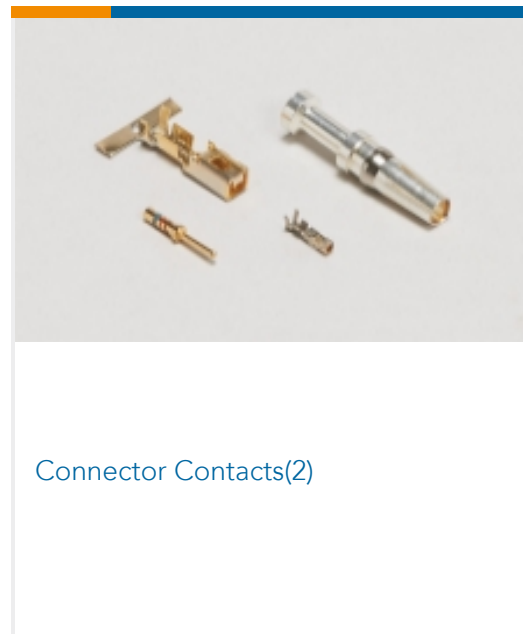
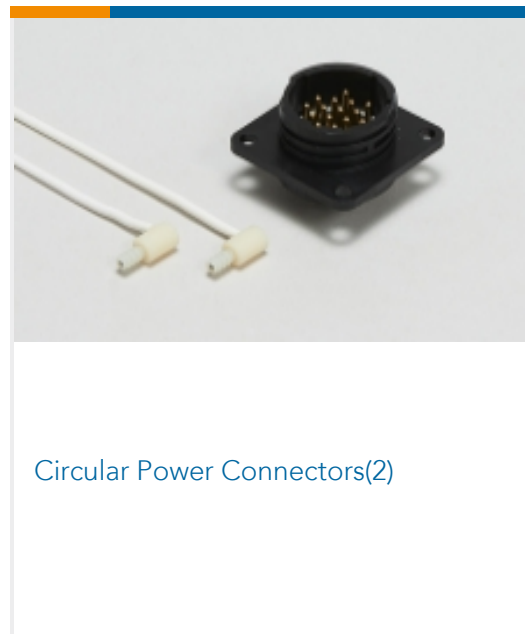

Customers Also Bought

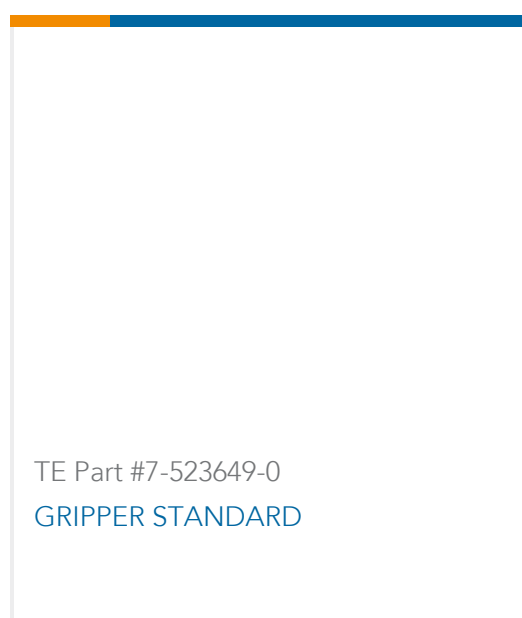
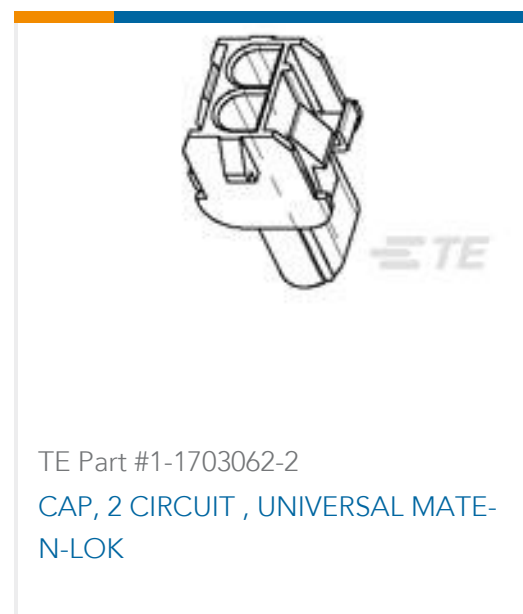

Documents

Product Drawings

[UNIV.M-N-L.PIN](#)

English

CAD Files

Customer View Model

[ENG_CVM_926886-3_K2.3d_igs.zip](#)

English

Customer View Model

[ENG_CVM_926886-3_K2.3d_stp.zip](#)

English

Customer View Model

[ENG_CVM_926886-3_K2.2d_dxf.zip](#)

English

[3D PDF](#)

English

By downloading the CAD file I accept and agree to the [Terms and Conditions](#) of use.

Product Specifications



Application Specification

English

Product Environmental Compliance

[MD_926886-3_07142014813_dmtec](#)

English

[MD_926886-3_07142014813_dmtec](#)

English

Agency Approvals

[VDE Certificate](#)

English