

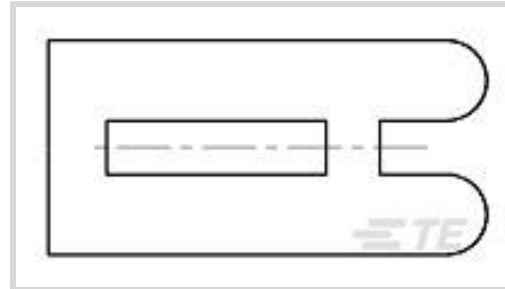

Connectors > PCB Connectors > PCB Connector Accessories > PCB Connector Keying



Connector Keying Accessory Type: **Keying Plug**

### Features

#### Product Type Features

Connector Keying Accessory Type	Keying Plug
---------------------------------	-------------

#### Packaging Features

Packaging Method	Bag
------------------	-----

### Product Compliance

[For compliance documentation, visit the product page on TE.com>](#)

EU RoHS Directive 2011/65/EU	Compliant
EU ELV Directive 2000/53/EC	Compliant
China RoHS 2 Directive MIIT Order No 32, 2016	No Restricted Materials Above Threshold
EU REACH Regulation (EC) No. 1907/2006	Current ECHA Candidate List: JUNE 2023 (235) Candidate List Declared Against: JUNE 2023 (235) Does not contain REACH SVHC
Halogen Content	Low Halogen - Br, Cl, F, I < 900 ppm per homogenous material. Also BFR/CFR/PVC Free
Solder Process Capability	Not applicable for solder process capability

#### Product Compliance Disclaimer

This information is provided based on reasonable inquiry of our suppliers and represents our current actual knowledge based on the information they provided. This information is subject to change. The part numbers that TE has identified as EU RoHS compliant have a maximum concentration of 0.1% by weight in homogenous materials for lead, hexavalent chromium, mercury, PBB, PBDE, DBP, BBP, DEHP, DIBP, and 0.01% for cadmium, or qualify for an exemption to these limits as defined in the Annexes of Directive 2011/65/EU (RoHS2). Finished electrical and electronic equipment products will be CE marked as required by Directive 2011/65/EU. Components may not be CE marked. Additionally, the part numbers that TE has identified as EU ELV compliant have a maximum concentration of 0.1% by weight in homogenous materials for lead, hexavalent chromium, and mercury, and 0.01% for cadmium, or qualify for an exemption to these limits as defined in the Annexes of Directive 2000/53/EC (ELV). Regarding the REACH Regulation, the information TE provides

on SVHC in articles for this part number is based on the latest European Chemicals Agency (ECHA) 'Guidance on requirements for substances in articles' posted at this URL: <https://echa.europa.eu/guidance-documents/guidance-on-reach>

## Compatible Parts



TE Part # 926476-3  
MOD 4 HSG



TE Part # 926476-8  
MOD 4 HSG



TE Part # 926475-3  
03P MODU 4 HSG.S.R.



TE Part # 926475-4  
MOD 4 HSG



TE Part # 926476-4  
2X4P MODU 4 HSG.



TE Part # 926476-6  
MOD 4 HSG



TE Part # 926475-8  
MOD 4 HSG



TE Part # 1-926475-0  
MOD 4 HSG



TE Part # 1-926476-7  
MOD 4 HSG



TE Part # 926475-7  
MOD 4 HSG



TE Part # 926475-5  
MOD 4 HSG



TE Part # 926475-6  
MOD IV HSG SR 6 POS



TE Part # 926476-5  
MOD 4 HSG



TE Part # 1-926476-3  
MOD 4 HSG



TE Part # 926476-7  
MOD 4 HSG



TE Part # 1-926476-0  
MOD 4 HSG



## Also in the Series | Modu Connector System

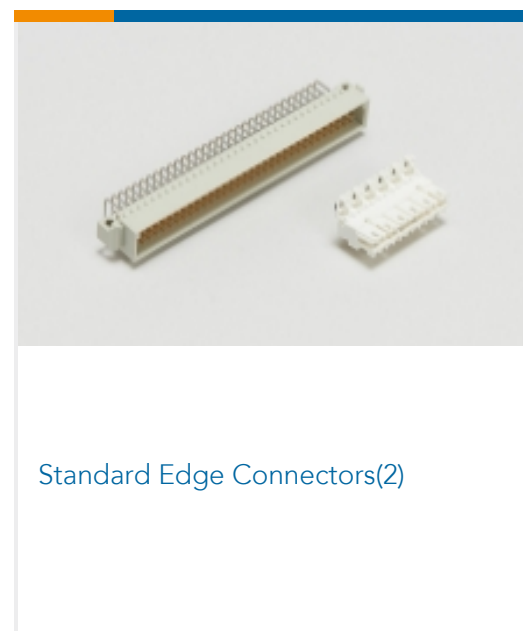
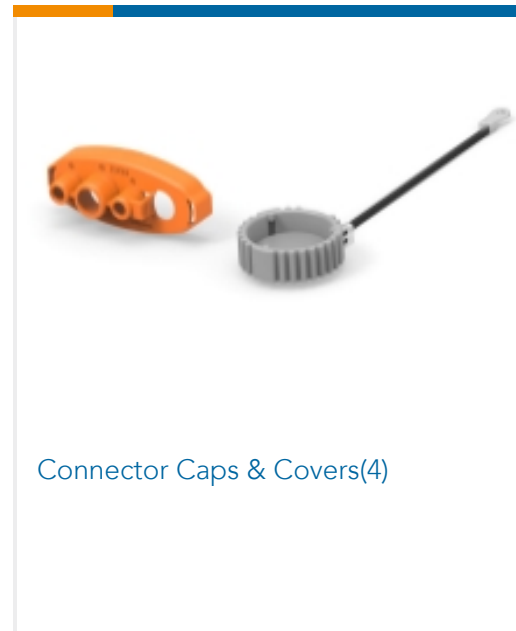
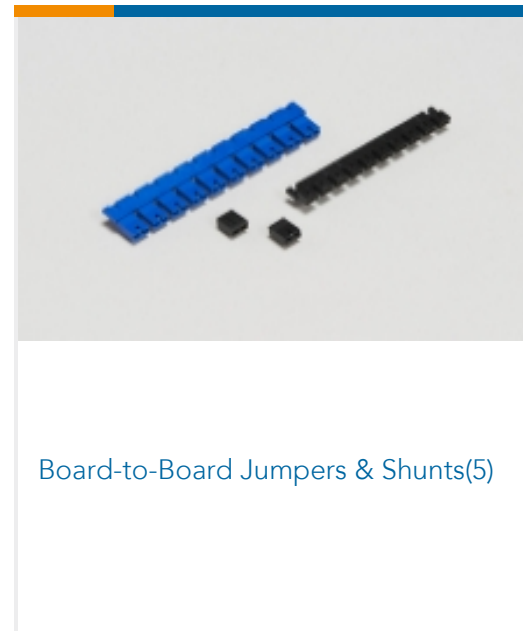
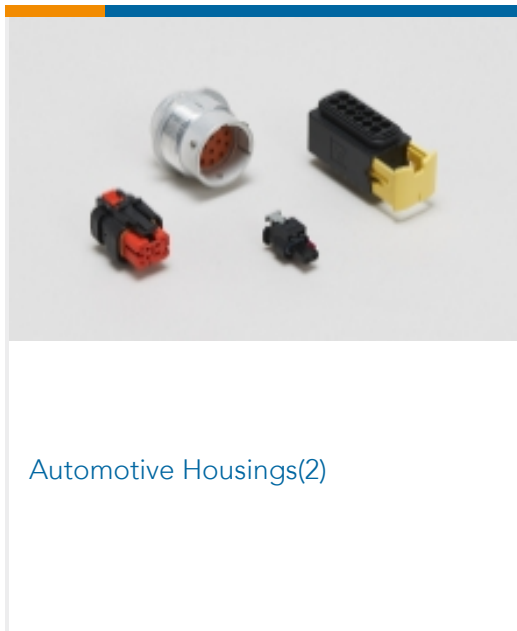

## Customers Also Bought

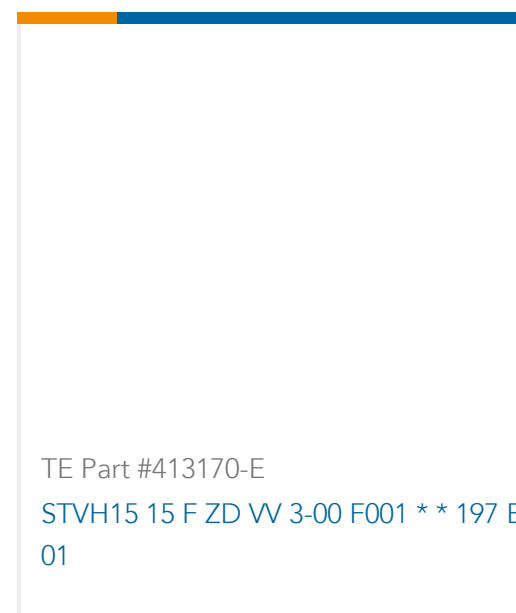
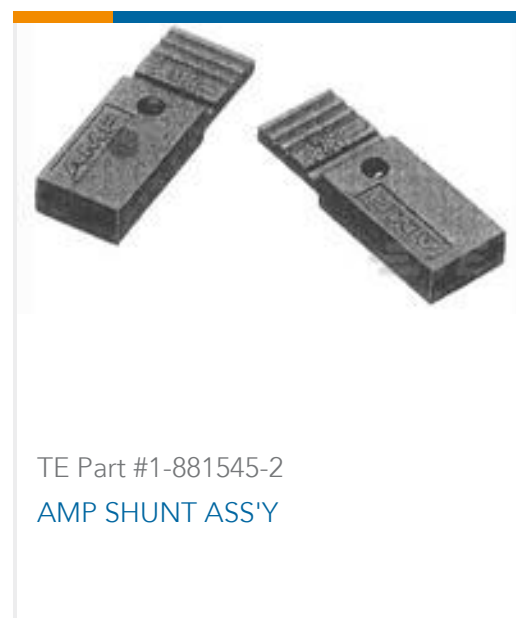
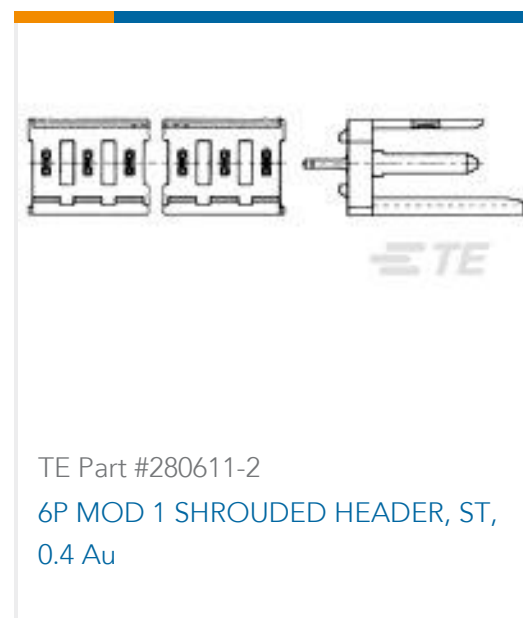



## Documents

### Product Drawings

[MOD2 KODIERSTUECK](#)

English

---

### CAD Files

Customer View Model

[ENG\\_CVM\\_926498-3\\_1.3d\\_igs.zip](#)

English

Customer View Model

[ENG\\_CVM\\_926498-3\\_1.3d\\_stp.zip](#)

English

Customer View Model

[ENG\\_CVM\\_926498-3\\_1.2d\\_dxf.zip](#)

English

[3D PDF](#)

3D

By downloading the CAD file I accept and agree to the [Terms and Conditions](#) of use.

---

### Product Specifications

[Product Specification](#)

English

---

### Product Environmental Compliance

[Product Compliance](#)

English

[Product Compliance](#)

English