



MATE-N-LOK | Commercial MATE-N-LOK

TE Internal #: 925714-2

Power Contacts, Contact, 250 VAC, Tin, 20 – 14 AWG Wire Size, .5 – 2 mm<sup>2</sup> Wire Size, Wire & Cable, Crimp, Power, Socket, Commercial MATE-N-LOK

[View on TE.com >](#)

Connectors > Power Connectors > Power Contacts

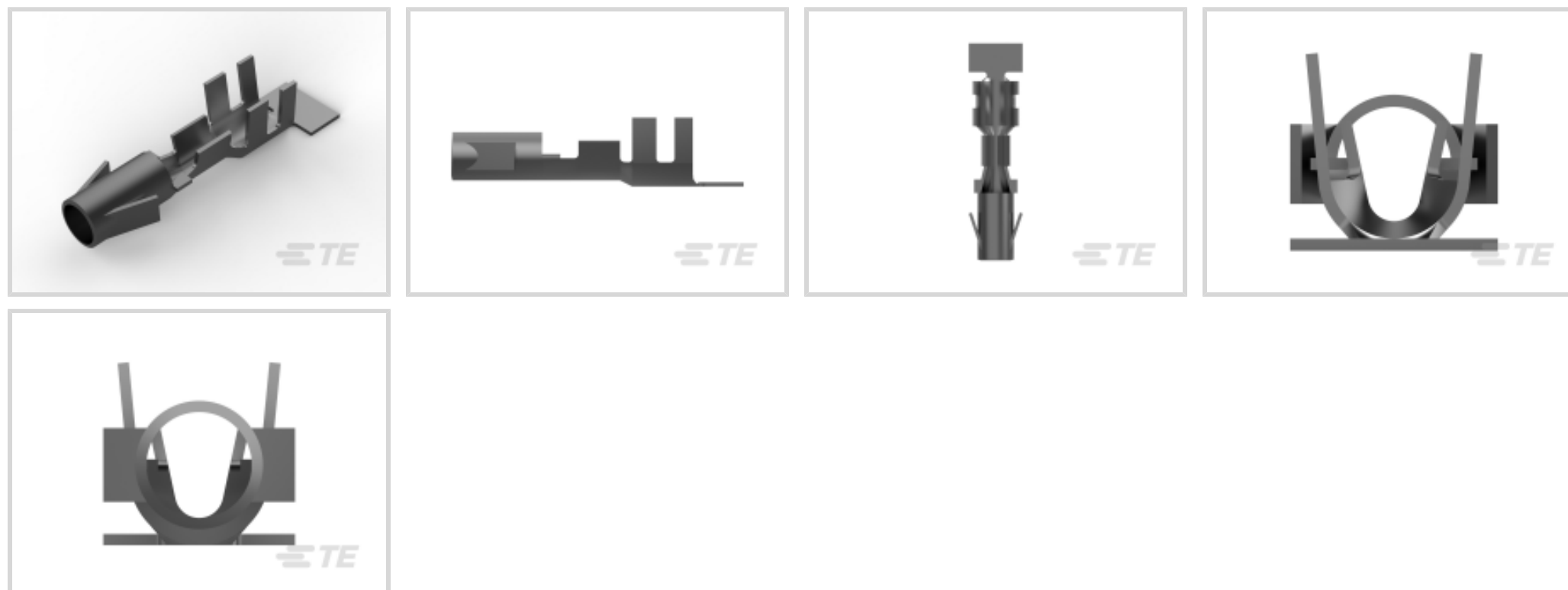

Power Contact Type: **Contact**

Operating Voltage: **250 VAC**

Contact Mating Area Plating Material: **Tin**

Wire Size: **.5 – 2 mm<sup>2</sup>**

**Features**

**Product Type Features**

Power Contact Type	Contact
Connector & Contact Terminates To	Wire & Cable

**Electrical Characteristics**

Operating Voltage	250 VAC
-------------------	---------

**Contact Features**

Contact Mating Area Plating Material	Tin
Contact Current Rating (Max)	17 A
Contact Type	Socket
Contact Retention Within Housing	With
Mating Pin Diameter	3.56 mm[.14 in]
Contact Base Material	Phosphor Bronze
Wire Contact Termination Area Plating Material	Pre-Tin
Wire Contact Termination Area Plating Material Finish	Matte
Contact Orientation	Straight



### Termination Features

Termination Method to Wire & Cable	Crimp
------------------------------------	-------

### Mechanical Attachment

Contact Retention Type Within Housing	Locking Lance
Wire Insulation Support	With

### Dimensions

Wire Size	.5 – 2 mm <sup>2</sup>
Compatible Insulation Diameter Range	2.5 – 4.5 mm [.098 – .177 in]

### Usage Conditions

Operating Temperature Range	-55 – 105 °C [-67 – 221 °F]
-----------------------------	-----------------------------

### Operation/Application

Circuit Application	Power
---------------------	-------

### Packaging Features

Packaging Quantity	2500
Packaging Method	Reel

## Product Compliance

[For compliance documentation, visit the product page on TE.com>](#)

EU RoHS Directive 2011/65/EU	Compliant
EU ELV Directive 2000/53/EC	Compliant
China RoHS 2 Directive MIIT Order No 32, 2016	No Restricted Materials Above Threshold
EU REACH Regulation (EC) No. 1907/2006	Current ECHA Candidate List: JUNE 2023 (235) Candidate List Declared Against: JUNE 2023 (235) Does not contain REACH SVHC
Halogen Content	Low Halogen - Br, Cl, F, I < 900 ppm per homogenous material. Also BFR/CFR/PVC Free
Solder Process Capability	Not applicable for solder process capability

#### Product Compliance Disclaimer

This information is provided based on reasonable inquiry of our suppliers and represents our current actual knowledge based on the information they provided. This information is subject to change. The part numbers that TE has identified as EU RoHS compliant have a maximum concentration of 0.1% by weight in homogenous materials for lead, hexavalent chromium, mercury, PBB, PBDE, DBP, BBP, DEHP, DIBP, and 0.01% for cadmium, or qualify for an exemption to these limits as defined in the Annexes of Directive 2011/65/EU (RoHS2). Finished electrical and electronic equipment products

will be CE marked as required by Directive 2011/65/EU. Components may not be CE marked. Additionally, the part numbers that TE has identified as EU ELV compliant have a maximum concentration of 0.1% by weight in homogenous materials for lead, hexavalent chromium, and mercury, and 0.01% for cadmium, or qualify for an exemption to these limits as defined in the Annexes of Directive 2000/53/EC (ELV). Regarding the REACH Regulation, the information TE provides on SVHC in articles for this part number is based on the latest European Chemicals Agency (ECHA) 'Guidance on requirements for substances in articles' posted at this URL: <https://echa.europa.eu/guidance-documents/guidance-on-reach>

## Compatible Parts



TE Part # 1-480585-0  
09P .140 MNL PLUG NAT



TE Part # 1-350346-0  
03P .140 MNL PLUG P/M NAT



TE Part # 1-480672-0  
09P .140 MNL PLUG PM NAT



TE Part # 1-350344-0  
02P .140 MNL PLUG NAT



TE Part # 1-480510-0  
04P .140 MNL PLUG NAT



TE Part # 539764-1  
EXTRACTION TOOL



TE Part # 880124  
9 CIR PLUG 140DIA PANEL MT NAT



TE Part # 925451-1  
M-N-L SOCKET HSG



TE Part # 1-480672-9  
09P .140 MNL PLUG PM BLK

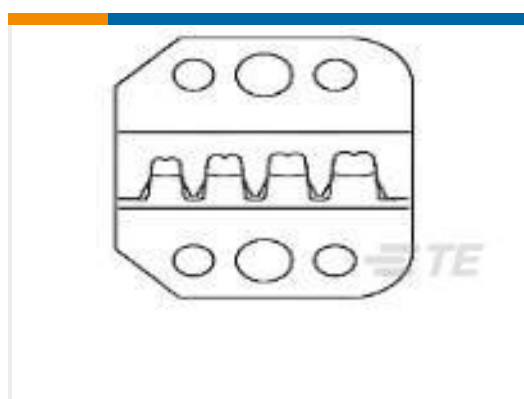

TE Part # 1752938-2  
SDE DIE SET 3.5 MM MNL



TE Part # 2-2151320-1  
OCEAN\_2.0\_APPLICATOR-S-100F190O180F



TE Part # 2-2151320-2  
OCEAN\_2.0\_APPLICATOR-S-100F190O180FA



TE Part # 2151320-1  
OCEAN\_2.0\_APPLICATOR-S-100F190O180F



TE Part # 2151320-2  
OCEAN\_2.0\_APPLICATOR-S-100F190O180FA



TE Part # 7-2151320-1  
OCEAN\_2.0\_APPLICATOR-S-100F190O180F



TE Part # 7-2151320-2  
OCEAN\_2.0\_APPLICATOR-S-100F190O180FA



## Also in the Series | Commercial MATE-N-LOK

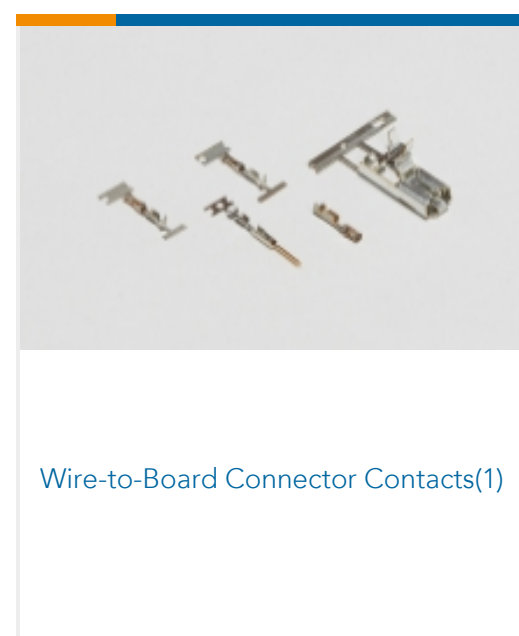
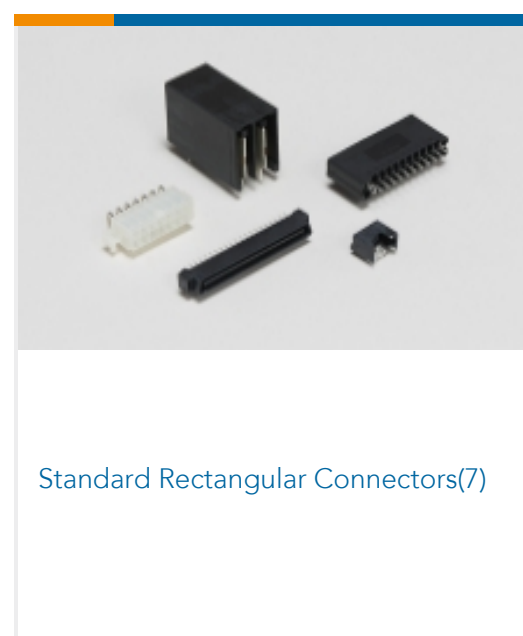
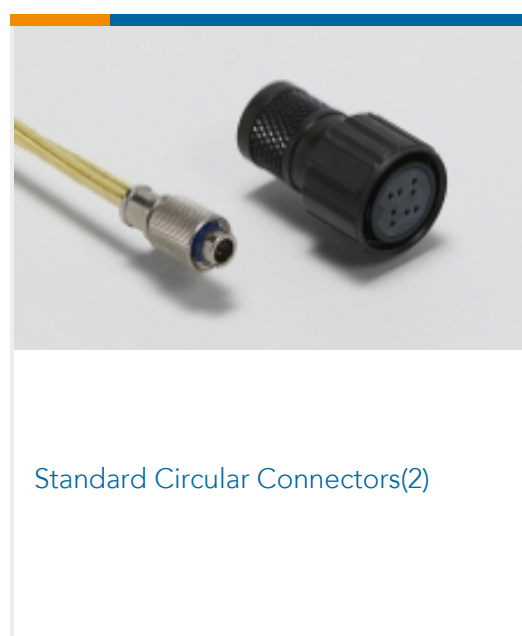
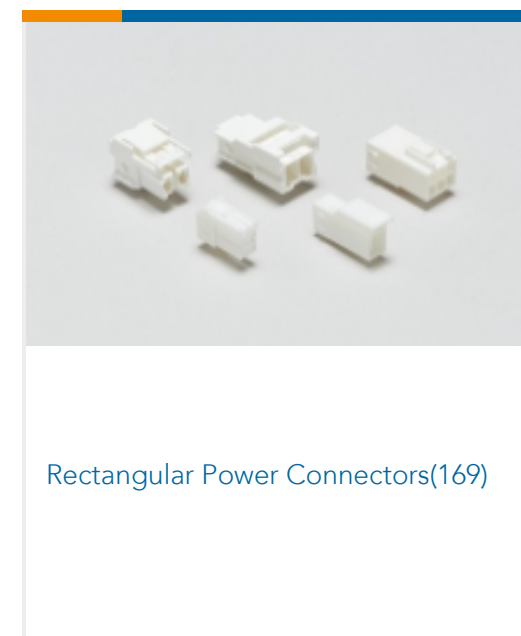
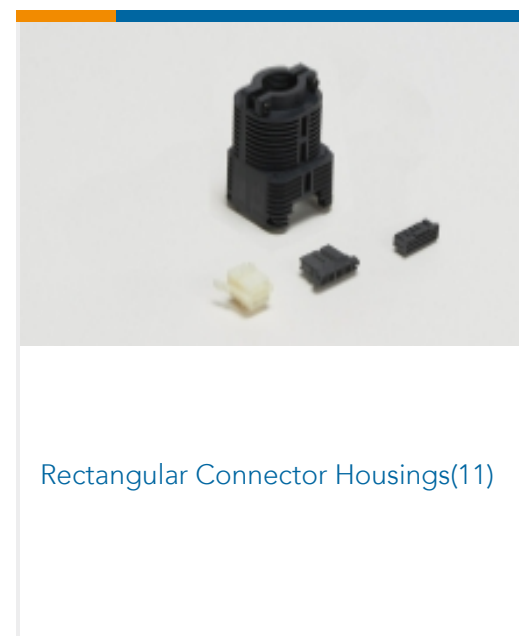
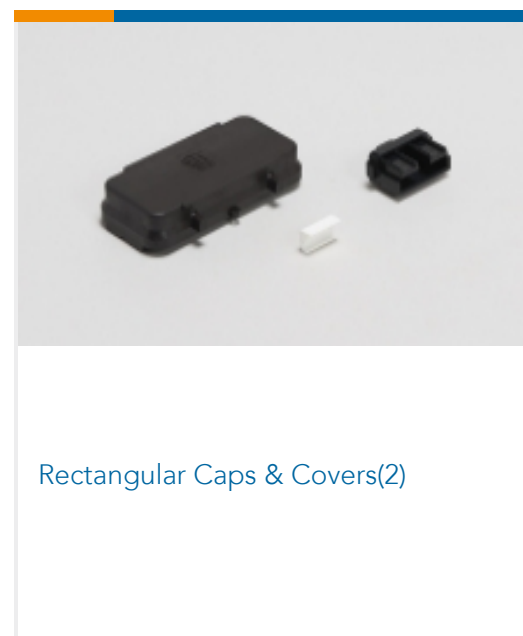
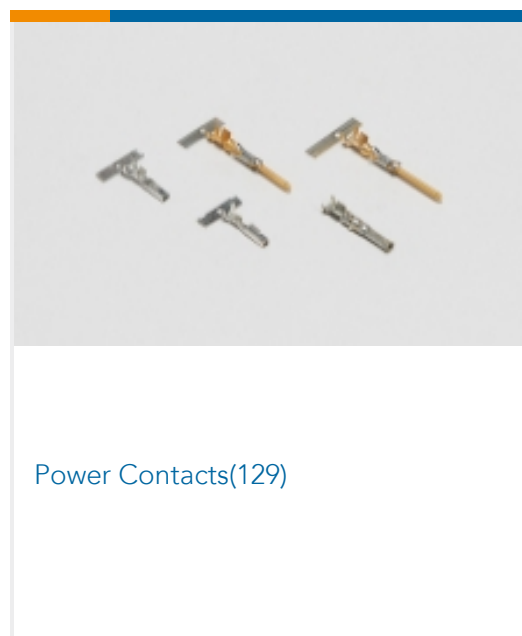
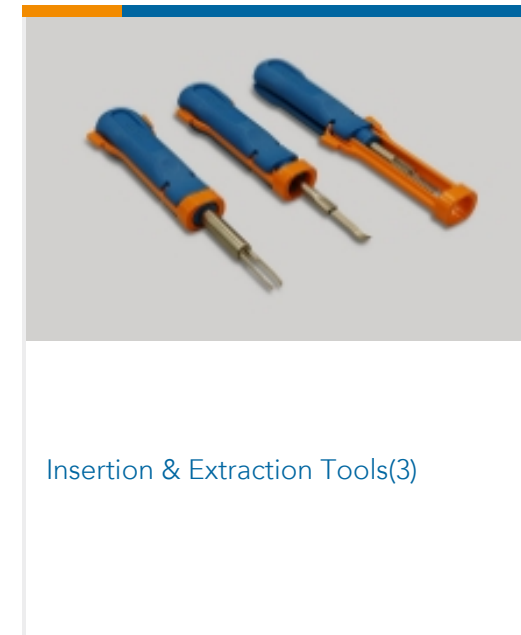
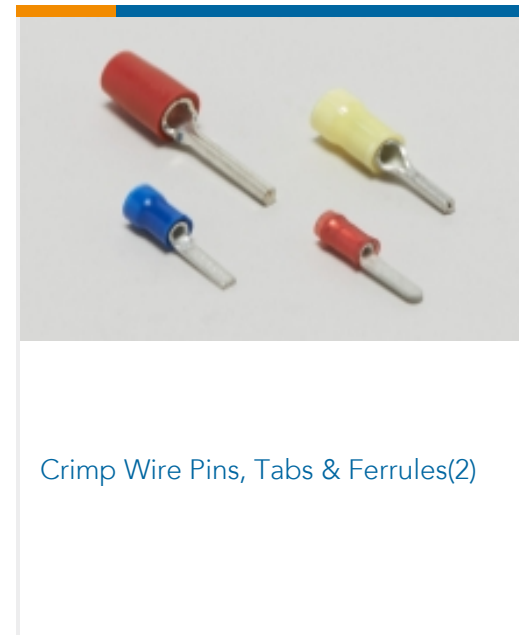
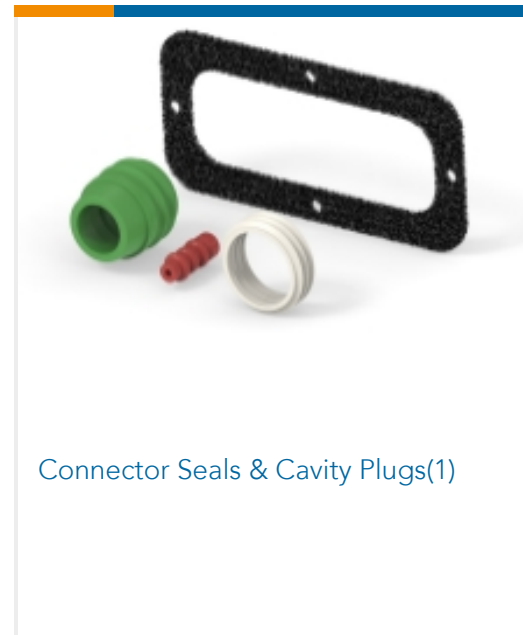
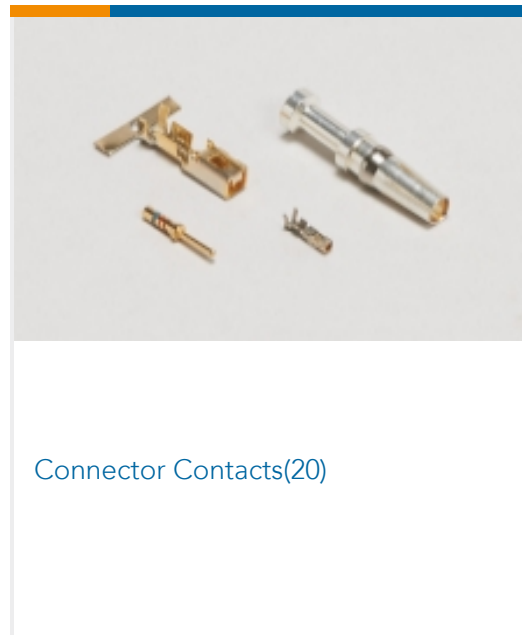

## Customers Also Bought

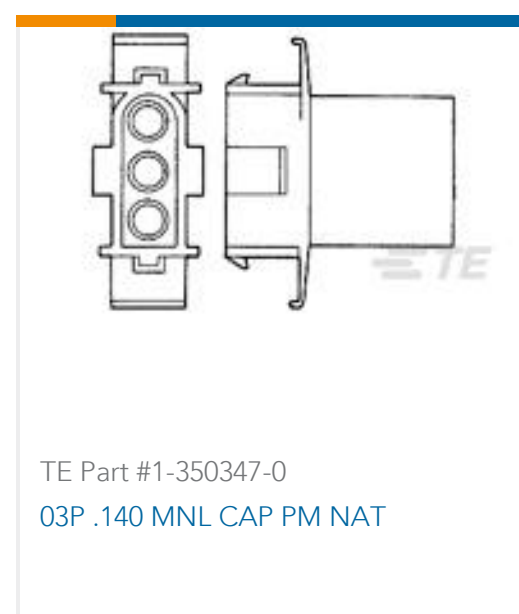





TE Part #160336-2  
RING TONGUE IS 12-10 0.295 X .650  
TPBR



TE Part #T4113412051-000  
M12 M, 5P GOLD B\_CODE RA  
SHIELDED PG9



TE Part #HD10-9-1939P-B022  
RECP ASM



TE Part #1929492002  
RNF-3000-18/6-2-STK



TE Part #5575754001  
CGPT-18/6-0-SP

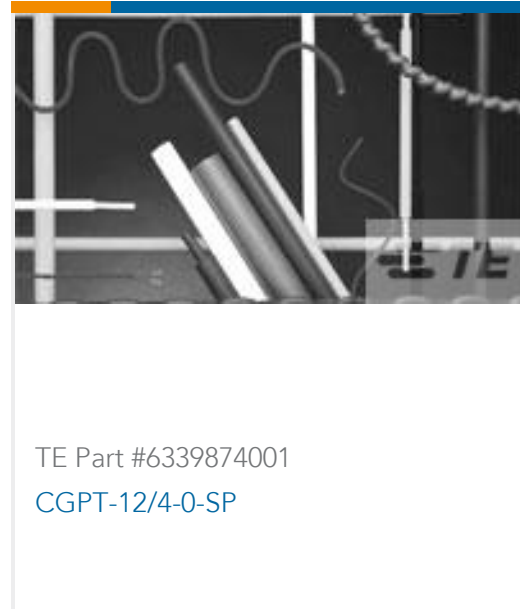

TE Part #6339874001  
CGPT-12/4-0-SP

## Documents

### Product Drawings

#### MATENLOK SOCKET.140

English

### CAD Files

#### Customer View Model

[ENG\\_CVM\\_925714-2\\_Y.3d\\_igs.zip](#)

English

#### Customer View Model

[ENG\\_CVM\\_925714-2\\_Y.3d\\_stp.zip](#)

English

#### Customer View Model

[ENG\\_CVM\\_925714-2\\_Y.2d\\_dxf.zip](#)

English

### 3D PDF

English

By downloading the CAD file I accept and agree to the [Terms and Conditions](#) of use.

### Product Specifications

#### Application Specification

English