

925595-1 ✓ ACTIVE

AMP | Timer Connector System

TE Internal #: 925595-1

Automotive Terminals, Receptacle, Mating Tab Width 2.8 mm [.11 in], Tab Thickness .8 mm [.031 in], 17 – 13 AWG Wire Size, Timer Connector System

[View on TE.com >](#)



Terminals & Splices > Automotive Terminals > TIMER, RECEPTACLE AND TAB

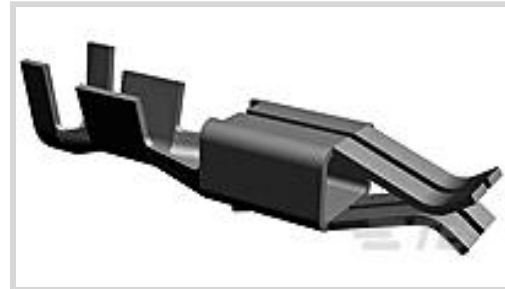

Terminal Type: **Receptacle**

Mating Tab Width: **2.8 mm [.11 in]**

Mating Tab Thickness: **.8 mm [.031 in]**

Terminal Transmits: **0 – 24 A (Low Power)**

Wire Size: **17 – 13 AWG**

[All TIMER, RECEPTACLE AND TAB \(348\)](#)

Features

Product Type Features

Receptacle Style	180°
Sealable	No
Primary Locking Feature	Locking Lance

Contact Features

Contact Size	2.8mm
Contact Fabrication	Stamped & Formed
Typical Current Rating	20 A
Crimp Type	F-Crimp
Terminal Type	Receptacle
Mating Tab Width	2.8 mm[.11 in]
Mating Tab Thickness	.8 mm[.031 in]
Interface Plating	Tin (Sn)

Termination Features

Termination Method to Wire & Cable	Crimp
Product Terminates To	Wire

Dimensions

Compatible Insulation Diameter Range	2.4 – 3.7 mm
--------------------------------------	--------------



Wire Size	1 – 2.5 mm ²
Wire Size Search	13 AWG, 14 AWG, 15 AWG, 16 AWG, 17 AWG

Usage Conditions

Insulation Option	Uninsulated
Operating Temperature (Max)	80 °C, 85 °C, 90 °C, 100 °C, 105 °C, 110 °C [176 °F][185 °F][194 °F][212 °F][221 °F][230 °F]
Operating Temperature Range	-40 – 110 °C[-40 – 230 °F]

Operation/Application

Compatible With Wire Base Material	Copper
------------------------------------	--------

Industry Standards

Agency/Standard	IEC 664/664A (DIN VDE 0110)
-----------------	-----------------------------

Packaging Features

Packaging Quantity	3750
Packaging Method	Reel

Other

Terminal Transmits	0 – 24 A (Low Power)
--------------------	----------------------

Product Compliance

For compliance documentation, visit the product page on [TE.com](https://www.te.com)>

EU RoHS Directive 2011/65/EU	Compliant
EU ELV Directive 2000/53/EC	Compliant
China RoHS 2 Directive MIIT Order No 32, 2016	No Restricted Materials Above Threshold
EU REACH Regulation (EC) No. 1907/2006	Current ECHA Candidate List: JUNE 2023 (235) Candidate List Declared Against: JUNE 2023 (235) Does not contain REACH SVHC
Halogen Content	Low Halogen - Br, Cl, F, I < 900 ppm per homogenous material. Also BFR/CFR/PVC Free
Solder Process Capability	Not applicable for solder process capability

Product Compliance Disclaimer

This information is provided based on reasonable inquiry of our suppliers and represents our current actual knowledge based on the information they provided. This information is subject to change. The part numbers that TE has identified as EU RoHS compliant have a maximum concentration of 0.1% by weight in homogenous materials for lead, hexavalent chromium, mercury, PBB, PBDE, DBP, BBP, DEHP, DIBP, and 0.01% for cadmium, or qualify for an exemption to these limits as defined in the Annexes of Directive 2011/65/EU (RoHS2). Finished electrical and electronic equipment products will be CE marked as required by Directive 2011/65/EU. Components may not be CE marked. Additionally, the part numbers that TE has identified as EU ELV compliant have a maximum concentration of 0.1% by weight in homogenous materials for lead, hexavalent chromium, and mercury, and 0.01% for cadmium, or qualify for an exemption to these limits as defined in the Annexes of Directive 2000/53/EC (ELV). Regarding the REACH Regulation, the information TE provides on SVHC in articles for this part number is based on the latest European Chemicals Agency (ECHA) 'Guidance on requirements for substances in articles' posted at this URL: <https://echa.europa.eu/guidance-documents/guidance-on-reach>

Compatible Parts



TE Part # CAT-T4827-CH8172
Timer Connector Housing



TE Part # 2305570-1
Strip Terminal Cutter-Side Feed-No Crimp



TE Part # 2063375-1
SDE JPT 0.5-2.5mm2 ASSY



TE Part # 2063375-2
SDE JPT 0.5-2.5mm2 DIE SET



TE Part # 2151245-2
OCEAN_2.0_Applicator-S-110F155F



TE Part # 7-2151245-2
OCEAN_2.0_Applicator-S-110F155F



TE Part # 7-2151245-7
OCEAN_2.0_SPARE_PART_KIT-110F155F

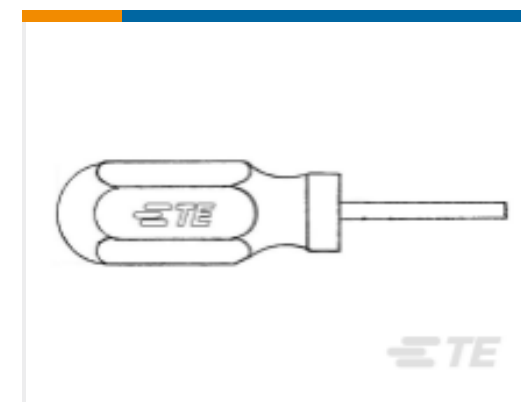

TE Part # 720788-8
EXTRCTION TOOL FOR MINI SPRING



TE Part # 539687-2
ERGOGRIMP DIE SET TIMER

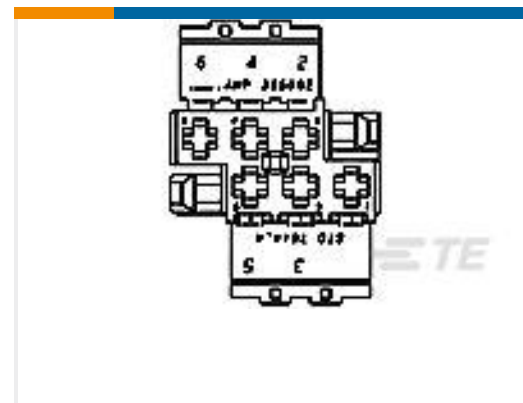

TE Part # 365066-4
14P HSG F/JUNIOR TIMER YLW

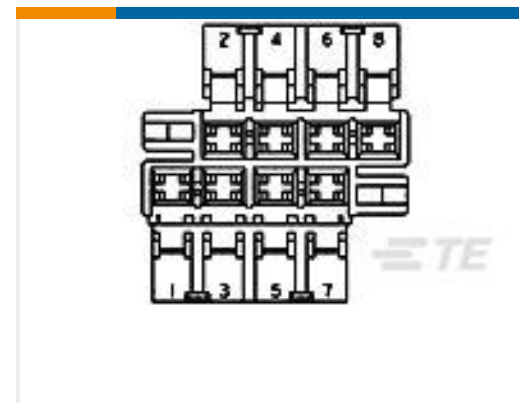

TE Part # 365064-1
8P HSG F/JUNIOR TIMER NAT



TE Part # 827551-4
2P MI D-FED KONTGEH



TE Part # 827551-8
2P MI D-FED KONTGEH

Also in the Series | Timer Connector System



Automotive Connector Caps & Covers (12)

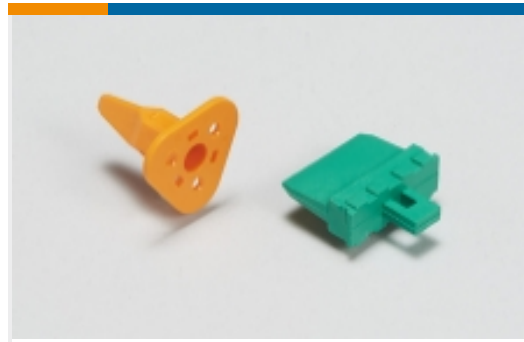

Automotive Connector Locks & Position Assurance(17)



Automotive Housings(233)

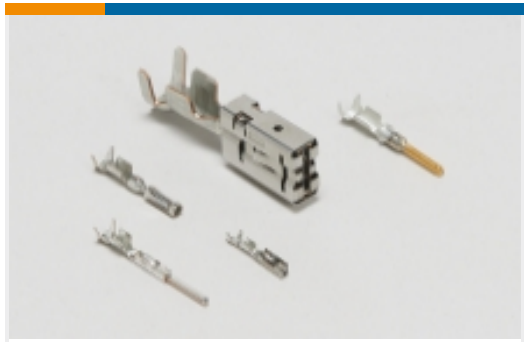

Automotive Terminals(145)



Connector Seals & Cavity Plugs(32)



Crimp Terminal Housings(13)



Insertion & Extraction Tools(18)



Other Automotive Connector Accessories(1)

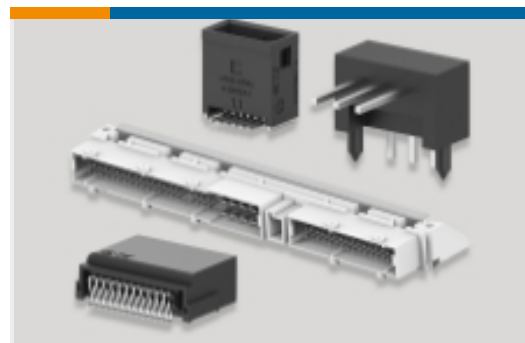

PCB Headers & Receptacles(82)



Quick Disconnects(4)

Customers Also Bought



TE Part #827551-3
Timer Connector Housing

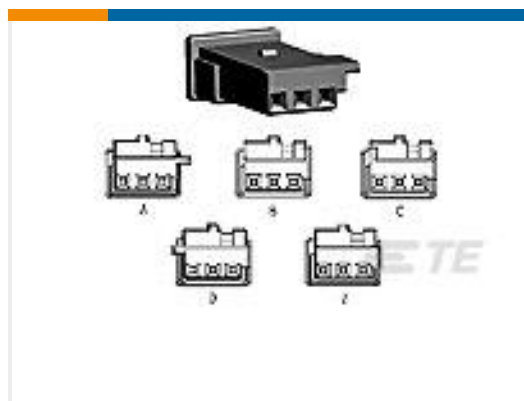

TE Part #4-1718346-1
3POS MQS REC COD D



TE Part #5745174-3
CABLE CLAMP KIT, SZ 4, .500



TE Part #2344656-4
WLAN DUAL BAND ANTENNA FPC V 200mm

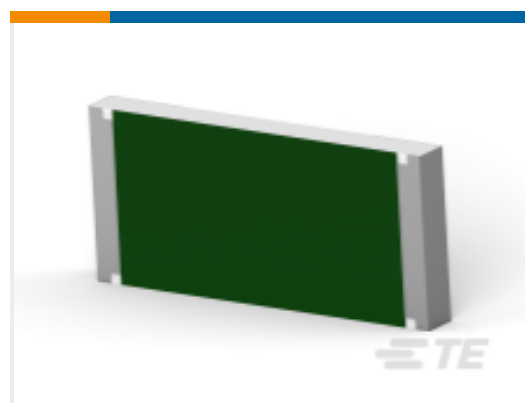

TE Part #6-2176403-0
3550 300R 1%



TE Part #2-2176343-3
CRGCO 1206 680R 1%



TE Part #1438136-1
70 WAY HARNESS ASSY KEYA(PROD)



TE Part #K1040809
Toggle Switch 07-1-2-10 D 905

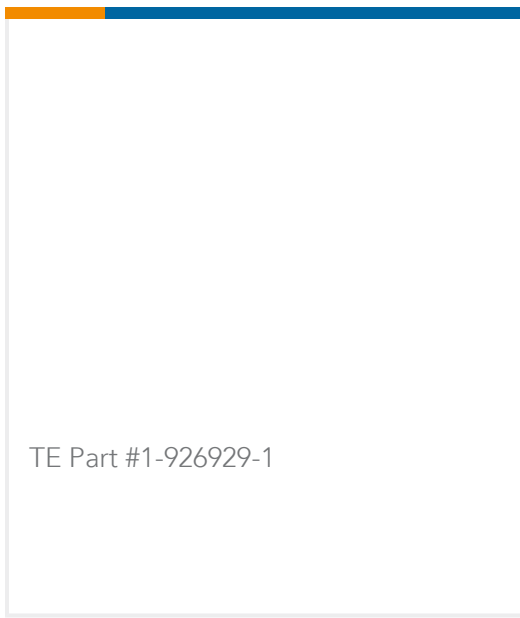

Documents

Product Drawings

[MIN.SPRING RECEPT.](#)

German

CAD Files

Customer View Model

[ENG_CVM_925595-1_R1.3d_igs.zip](#)

English

Customer View Model

[ENG_CVM_925595-1_R1.3d_stp.zip](#)

English

Customer View Model

[ENG_CVM_925595-1_R1.2d_dxf.zip](#)

English

[3D PDF](#)

English

By downloading the CAD file I accept and agree to the [Terms and Conditions](#) of use.

Datasheets & Catalog Pages

[Timer Interconnection System](#)

English

Product Specifications

[Application Specification](#)

German

[Application Specification](#)

English

[Application Specification](#)

Japanese

[CRIMPING L-JETRONIC* MINI-SPRING CONTACT](#)

English

[CRIMPING L-JETRONIC* MINI-SPRING CONTACT](#)

Japanese

[Application Specification](#)

English

925595-1

Automotive Terminals, Receptacle, Mating Tab Width 2.8 mm [.11 in], Tab Thickness .8 mm [.031 in], 17 – 13 AWG Wire Size, Timer Connector System

