

925450-1 ✓ ACTIVE

MATE-N-LOK | Commercial MATE-N-LOK

TE Internal #: 925450-1

Rectangular Power Connectors, Housing, Receptacle, Wire-to-Wire,  
18 Position, 6 mm / 5.2 mm [.236 in / .205 in] Centerline,  
Commercial MATE-N-LOK

[View on TE.com >](#)



Connectors > Power Connectors > Rectangular Power > Rectangular Power Connectors

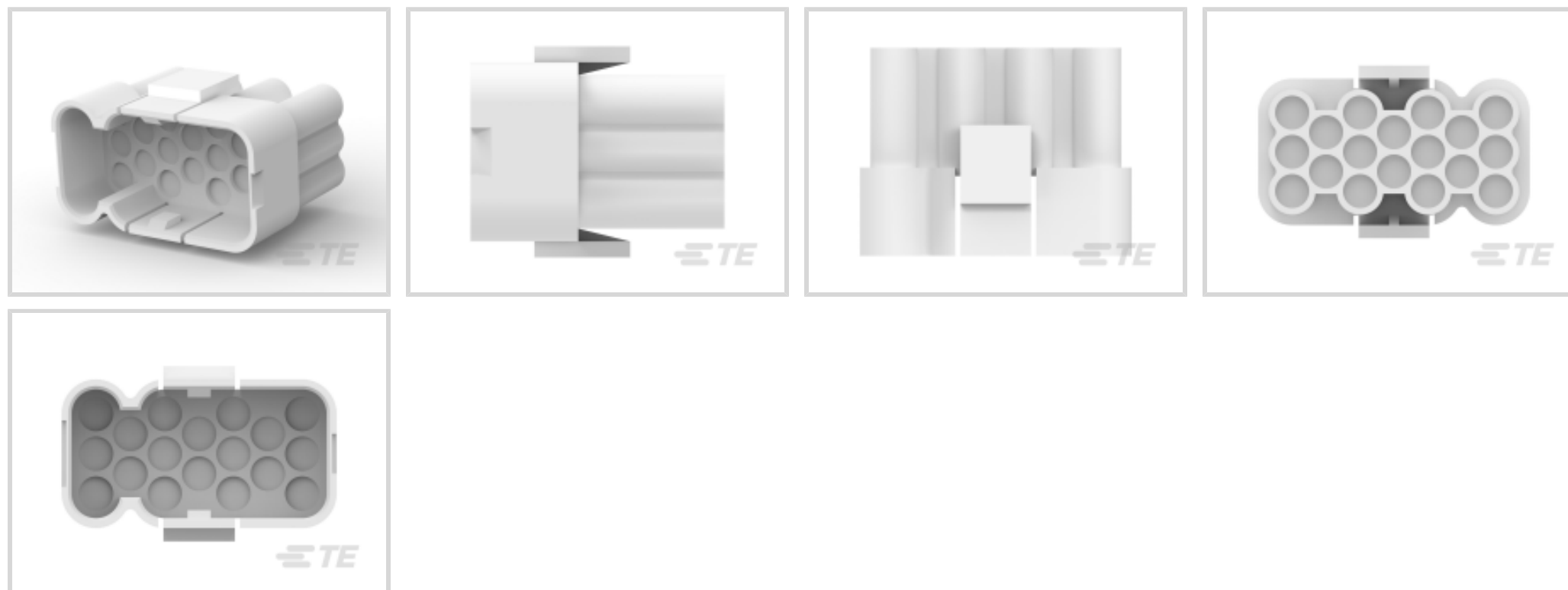

Rectangular Power Connector Type: **Housing**

Connector & Housing Type: **Receptacle**

Connector System: **Wire-to-Wire**

Number of Positions: **18**

Centerline (Pitch): **5.2 mm, 6 mm [.205 in, .236 in]**

## Features

### Product Type Features

Rectangular Power Connector Type	Housing
Connector & Housing Type	Receptacle
Connector System	Wire-to-Wire
Sealable	No
Connector & Contact Terminates To	Wire & Cable

### Configuration Features

Number of Positions	18
Number of Rows	5

### Electrical Characteristics

Operating Voltage	250 VAC
-------------------	---------

### Contact Features

Contact Layout	Matrix
Contact Retention Within Housing	Without
Contact Type	Pin



### Termination Features

Termination Method to Wire & Cable	Crimp
------------------------------------	-------

### Mechanical Attachment

Connector Mounting Type	Cable Mount (Free-Hanging)
-------------------------	----------------------------

### Housing Features

Centerline (Pitch)	5.2 mm, 6 mm [.205 in][.236 in]
--------------------	---------------------------------

Housing Color	Natural
---------------	---------

Housing Material	Polyamide 6.6
------------------	---------------

### Dimensions

Connector Height	31.8 mm
------------------	---------

Product Width	22.4 mm
---------------	---------

Product Length	41.6 mm
----------------	---------

Row-to-Row Spacing	3 mm [.118 in]
--------------------	----------------

### Usage Conditions

Operating Temperature Range	-55 – 105 °C [-67 – 221 °F]
-----------------------------	-----------------------------

### Operation/Application

Circuit Application	Power & Signal
---------------------	----------------

### Industry Standards

UL Flammability Rating	UL 94V-0
------------------------	----------

Glow Wire Rating	Standard Part - Not Glow Wire
------------------	-------------------------------

### Packaging Features

Packaging Quantity	1400
--------------------	------

Packaging Method	Bag
------------------	-----

### Product Compliance

[For compliance documentation, visit the product page on TE.com>](#)

EU RoHS Directive 2011/65/EU	Compliant
------------------------------	-----------

EU ELV Directive 2000/53/EC	Compliant
-----------------------------	-----------

China RoHS 2 Directive MIIT Order No 32, 2016	No Restricted Materials Above Threshold
---	---

EU REACH Regulation (EC) No. 1907/2006	Current ECHA Candidate List: JUNE 2023 (235)
--	--



Candidate List Declared Against: JUNE 2023 (235)

Does not contain REACH SVHC

Halogen Content

Low Halogen - Br, Cl, F, I < 900 ppm per homogenous material. Also BFR/CFR/PVC Free

Solder Process Capability

Not applicable for solder process capability

Product Compliance Disclaimer

This information is provided based on reasonable inquiry of our suppliers and represents our current actual knowledge based on the information they provided. This information is subject to change. The part numbers that TE has identified as EU RoHS compliant have a maximum concentration of 0.1% by weight in homogenous materials for lead, hexavalent chromium, mercury, PBB, PBDE, DBP, BBP, DEHP, DIBP, and 0.01% for cadmium, or qualify for an exemption to these limits as defined in the Annexes of Directive 2011/65/EU (RoHS2). Finished electrical and electronic equipment products will be CE marked as required by Directive 2011/65/EU. Components may not be CE marked. Additionally, the part numbers that TE has identified as EU ELV compliant have a maximum concentration of 0.1% by weight in homogenous materials for lead, hexavalent chromium, and mercury, and 0.01% for cadmium, or qualify for an exemption to these limits as defined in the Annexes of Directive 2000/53/EC (ELV). Regarding the REACH Regulation, the information TE provides on SVHC in articles for this part number is based on the latest European Chemicals Agency (ECHA) 'Guidance on requirements for substances in articles' posted at this URL: <https://echa.europa.eu/guidance-documents/guidance-on-reach>

## Compatible Parts

TE Part # 350389-1  
.140 DIA PIN 20-14 PTPBR L/P

TE Part # 925660-2  
140 DIA PIN

TE Part # 925660-1  
.140 DIA PIN

TE Part # 925715-1  
M-N-L PIN TPBR

TE Part # 61627-1  
.140 DIA PIN 20-14 PTPBR

TE Part # 350201-1  
.140 DIA PIN 14-10 PTPBR

TE Part # 880685-2  
.140 DIA PIN

TE Part # 926988-1  
MNL STIFT 3,5 MM



Also in the Series | Commercial MATE-N-LOK

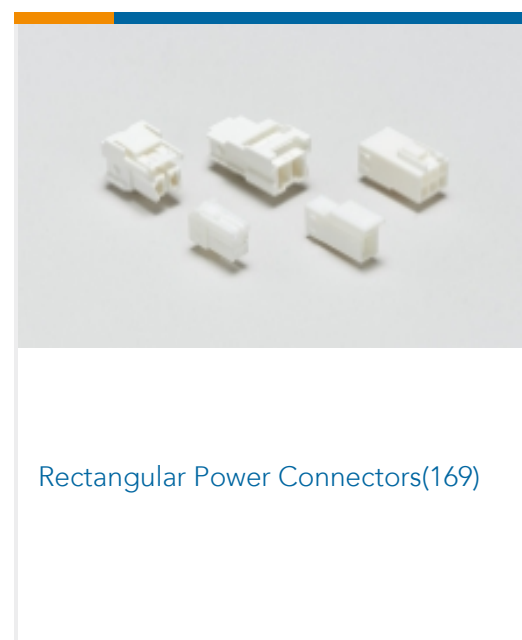
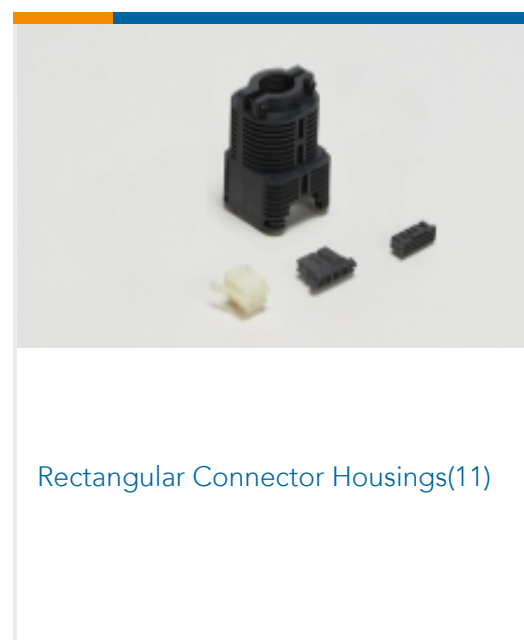
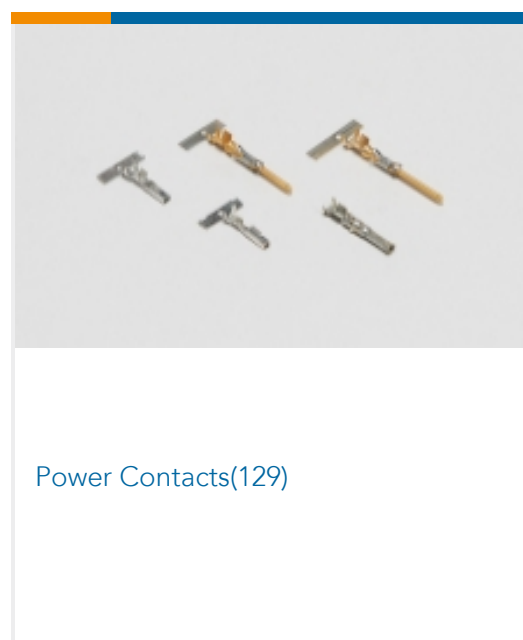
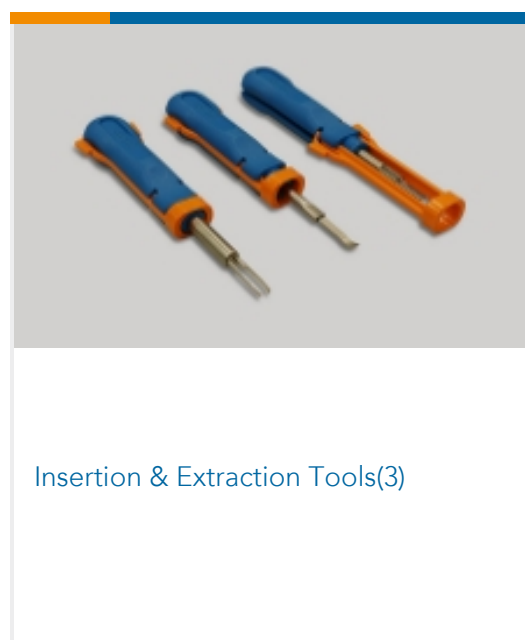
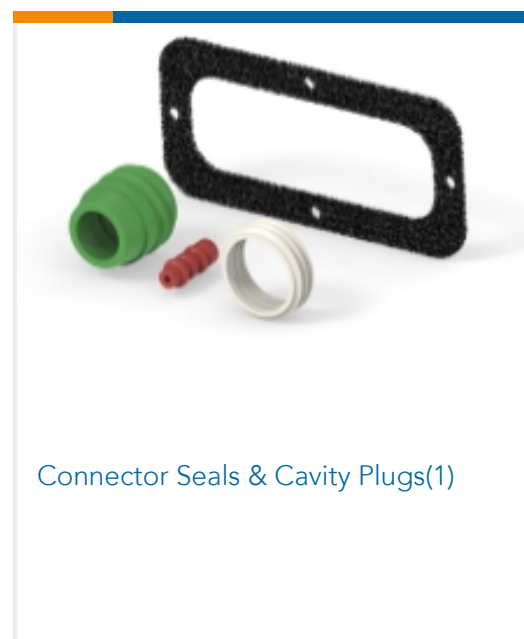
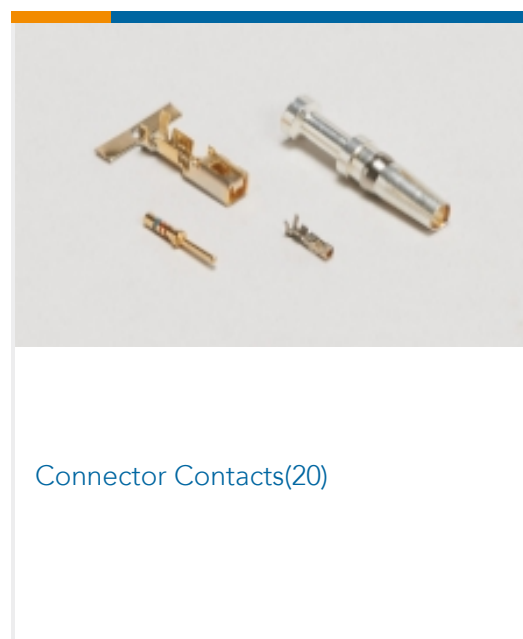
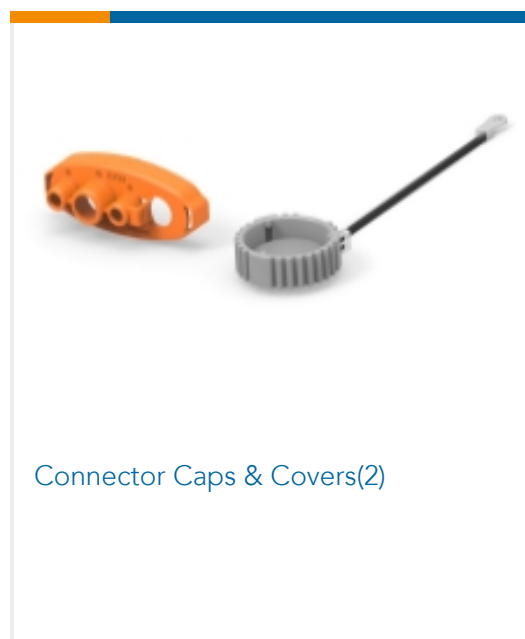





Standard Circular Connectors(2)



Standard Rectangular Connectors(7)



Wire-to-Board Connector Contacts(1)

## Customers Also Bought

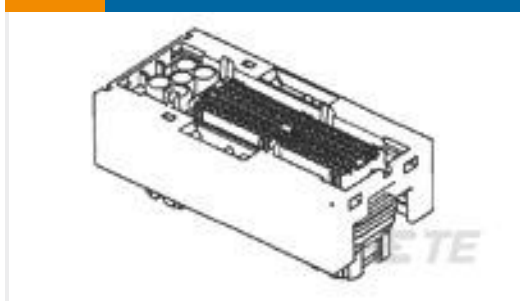

TE Part #1473252-1  
40POS MIXED MQS REC SEALED



TE Part #1658684-1  
HDP-22,RCPT,SIZE 4,62 POSN



TE Part #1740260-2  
NECTOR S TUBE BLACK



TE Part #293388-3  
NECTOR S PLUG HV-4 WHITE



TE Part #1740260-1  
NECTOR S TUBE WHITE



TE Part #1394871-1  
MQS DICHTSTOPFEN



TE Part #HDP24-18-14SN  
REC, 14P, BLK, N, 16, S



TE Part #7223870001  
TMS-SCE-1/8-2.0-S1-4

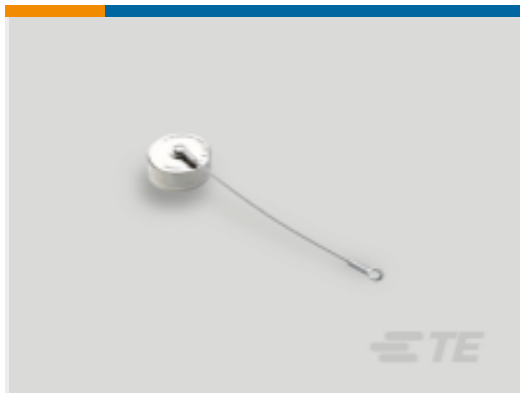

TE Part #YDTS33F15NV0010000  
DUST COVER ASSEM

## Documents

### Product Drawings

M-N-L PIN HSG

English

### CAD Files

3D PDF

English

### Customer View Model

ENG\_CVM\_925450-1\_A.2d\_dxf.zip



English

**Customer View Model**

[ENG\\_CVM\\_925450-1\\_A.3d\\_igs.zip](#)

English

**Customer View Model**

[ENG\\_CVM\\_925450-1\\_A.3d\\_stp.zip](#)

English

By downloading the CAD file I accept and agree to the [Terms and Conditions](#) of use.

**Product Specifications**

[Application Specification](#)

English