



PIDG

TE Internal #: 9-160313-2

Quick Disconnects, Receptacle, 17 – 13 AWG Wire Size, 1 – 2.5 mm² Wire Size, 1980 – 4914 CMA Wire Size, Mating Tab Width 6.35 mm [.25 in], PIDG

[View on TE.com >](#)

Terminals & Splices > Quick Disconnects > PIDG FASTON Receptacle Quick Disconnects

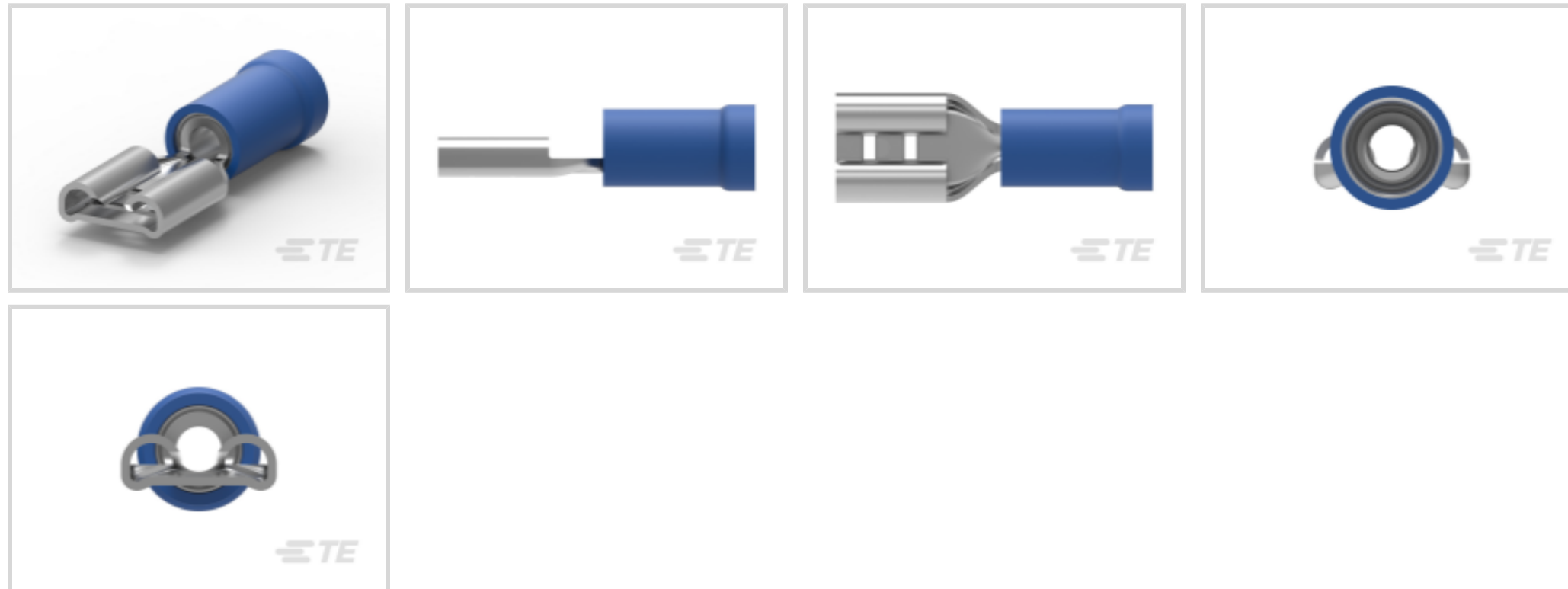

Quick Disconnect Terminal Type: **Receptacle**

Wire Size: **1980 – 4914 CMA**

Mating Tab Width: **6.35 mm [.25 in]**

[All PIDG FASTON Receptacle Quick Disconnects \(21\)](#)

Features

Product Type Features

Terminal Features	Wire Stop
Insertion Force	Normal

Configuration Features

Connection Capacity	Single
---------------------	--------

Electrical Characteristics

Voltage Rating	300 V
----------------	-------

Body Features

Insulation Material	Nylon
---------------------	-------

Contact Features

Quick Disconnect Terminal Type	Receptacle
Mating Tab Width	6.35 mm [.25 in]
Mating Tab Thickness	.81 mm [.032 in]
Terminal Orientation	Straight



Contact Base Material	Brass
Terminal Plating Material	Tin
Crimp Type	Compression
Barrel Type	Closed

Termination Features

Product Terminates To	Wire & Cable
-----------------------	--------------

Mechanical Attachment

Wire Insulation Support	With
Mating Retention Type	Dimple

Dimensions

Product Length	23.2 mm[.913 in]
Compatible Insulation Diameter Range	4.32 mm[.17 in]
Wire Size	1980 – 4914 CMA

Usage Conditions

Insulation Option	Partially Insulated
Operating Temperature Range	105 °C[221 °F]

Packaging Features

Packaging Quantity	1000
Packaging Method	Box

Other

Barrel Color	Blue
--------------	------

Product Compliance

[For compliance documentation, visit the product page on TE.com>](#)

EU RoHS Directive 2011/65/EU	Compliant
EU ELV Directive 2000/53/EC	Compliant
China RoHS 2 Directive MIIT Order No 32, 2016	No Restricted Materials Above Threshold
EU REACH Regulation (EC) No. 1907/2006	Current ECHA Candidate List: JUNE 2023 (235) Candidate List Declared Against: JUNE 2023 (235) Does not contain REACH SVHC
Halogen Content	Low Halogen - Br, Cl, F, I < 900 ppm per homogenous material. Also BFR/CFR/PVC

Free

Solder Process Capability

Not applicable for solder process capability

Product Compliance Disclaimer

This information is provided based on reasonable inquiry of our suppliers and represents our current actual knowledge based on the information they provided. This information is subject to change. The part numbers that TE has identified as EU RoHS compliant have a maximum concentration of 0.1% by weight in homogenous materials for lead, hexavalent chromium, mercury, PBB, PBDE, DBP, BBP, DEHP, DIBP, and 0.01% for cadmium, or qualify for an exemption to these limits as defined in the Annexes of Directive 2011/65/EU (RoHS2). Finished electrical and electronic equipment products will be CE marked as required by Directive 2011/65/EU. Components may not be CE marked. Additionally, the part numbers that TE has identified as EU ELV compliant have a maximum concentration of 0.1% by weight in homogenous materials for lead, hexavalent chromium, and mercury, and 0.01% for cadmium, or qualify for an exemption to these limits as defined in the Annexes of Directive 2000/53/EC (ELV). Regarding the REACH Regulation, the information TE provides on SVHC in articles for this part number is based on the latest European Chemicals Agency (ECHA) 'Guidance on requirements for substances in articles' posted at this URL: <https://echa.europa.eu/guidance-documents/guidance-on-reach>

Compatible Parts



REPRESENTATION ONLY

TE Part # 47387
DAHT PG PIDG 20-14 ASSY



TE Part # 58423-1
DIE, RBY IS9252



REPRESENTATION ONLY

TE Part # 47387-7
DAHT PG PIDG 16-12 ASSY



TE Part # 58433-3
PRO CR ASSY, RBY IS9252



REPRESENTATION ONLY

TE Part # 525691
DAHT PG PIDG 16-14 ASSY



TE Part # 539691-2
ERGO DIE R.B.Y



REPRESENTATION ONLY

TE Part # 90009-8
DAHT PIDG FASTON 16-14 ASSY



TE Part # 1377175-6
SMP 9-0160313-2



TE Part # 2063030-1
SDE DIESET, RBY, UL



TE Part # 169400
CERTI-LOK FRAME W/O DIES

TE Part # 2392022-2
BLUE BATTERY DAHT KIT 220V (47387-7)

TE Part # 2392022-1
BLUE BATTERY DAHT KIT 110V (47387-7)



Also in the Series | PIDG

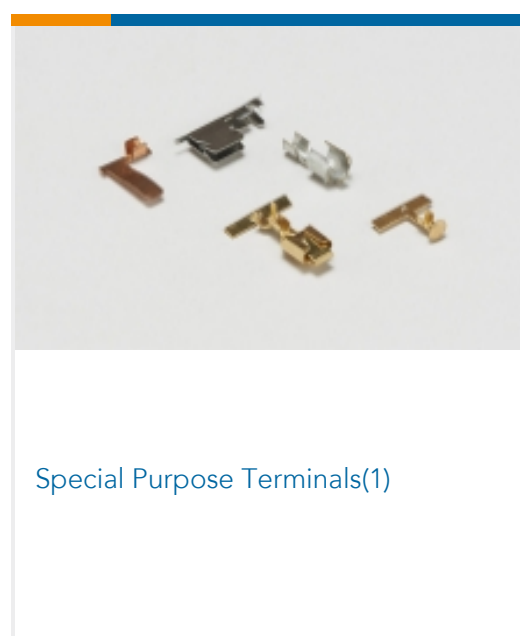
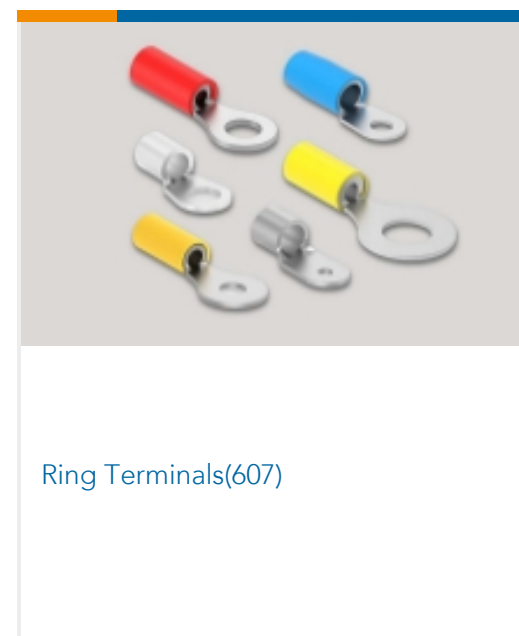
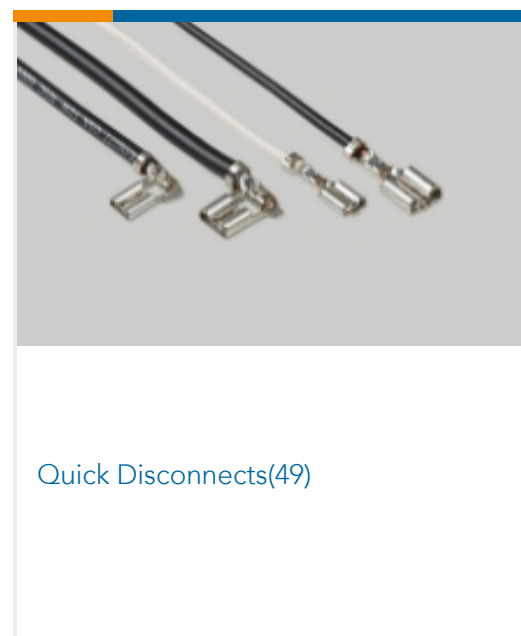
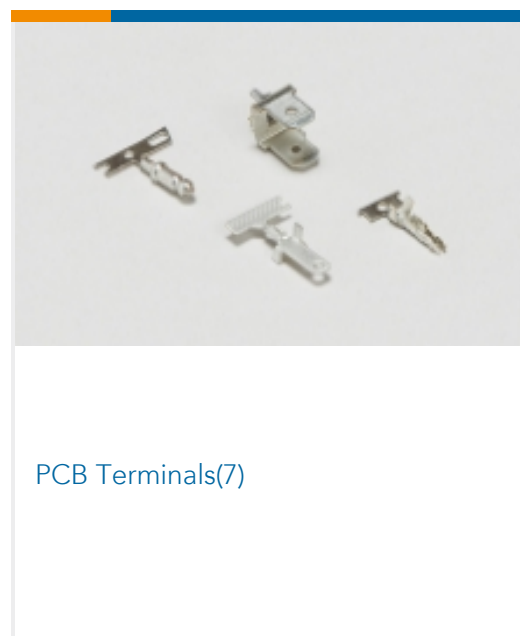
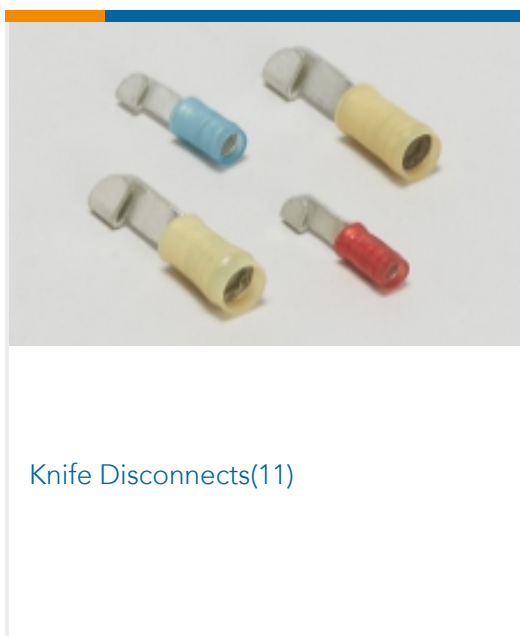
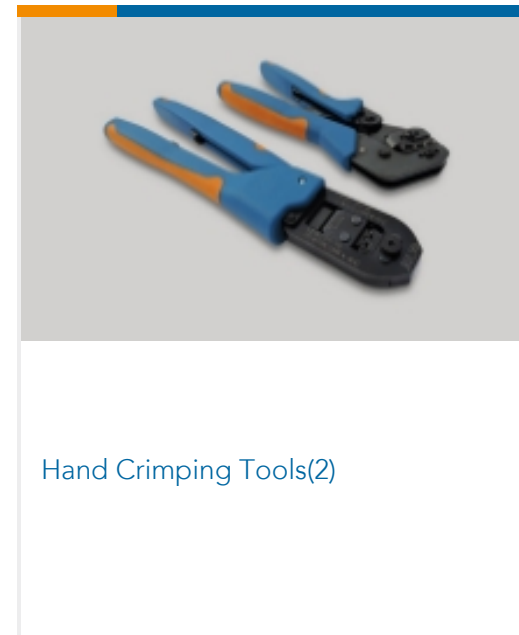
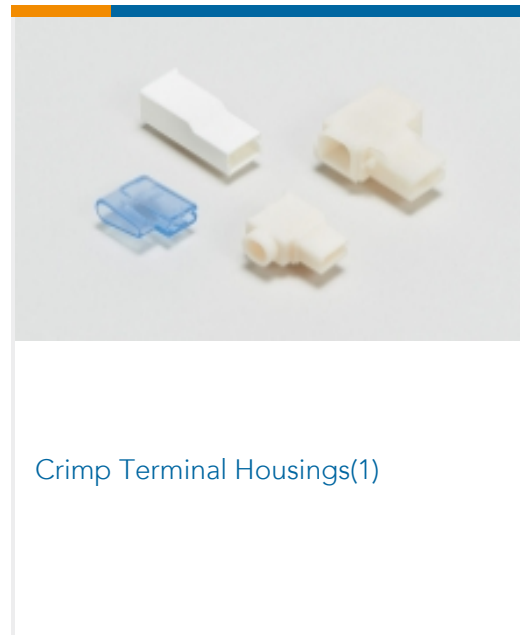
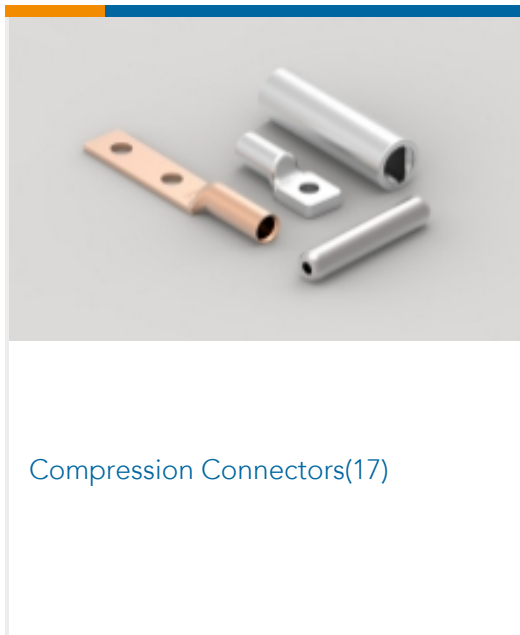

Customers Also Bought

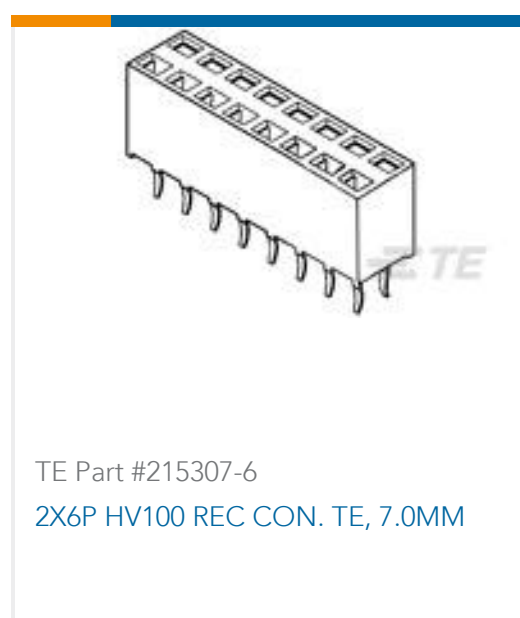

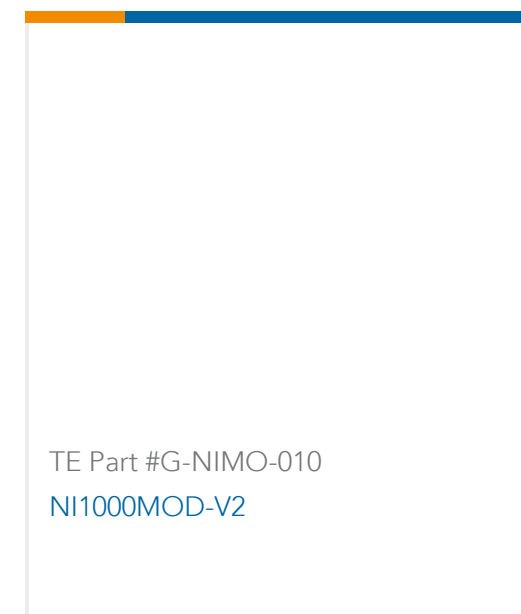
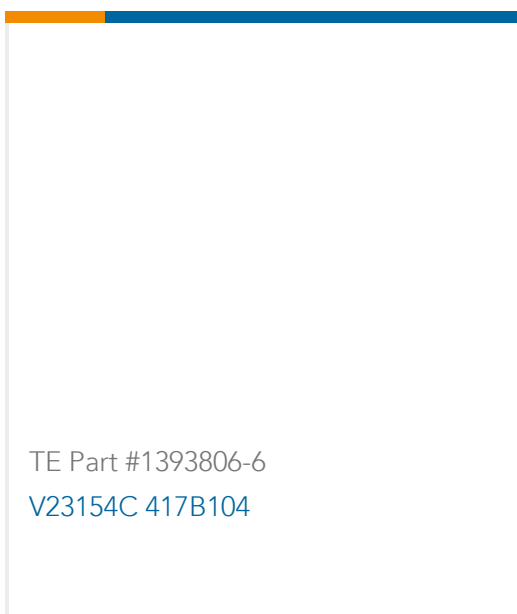

Documents

Product Drawings

250 PIDG FASTON REC

English

CAD Files

3D PDF

English

Customer View Model

[ENG_CVM_9-160313-2_H1.2d_dxf.zip](#)

English

Customer View Model

[ENG_CVM_9-160313-2_H1.3d_igs.zip](#)

English

Customer View Model

[ENG_CVM_9-160313-2_H1.3d_stp.zip](#)

English

3D PDF

3D

Customer View Model

[ENG_CVM_CVM_9-160313-2_V.2d_dxf.zip](#)

English

Customer View Model

[ENG_CVM_CVM_9-160313-2_V.3d_igs.zip](#)

English

Customer View Model

[ENG_CVM_CVM_9-160313-2_V.3d_stp.zip](#)

English



By downloading the CAD file I accept and agree to the [Terms and Conditions](#) of use.

Datasheets & Catalog Pages

[PIDG Terminals and Splices Quick Reference Guide](#)

English

[PIDG TERMINALS & SPLICES Quick Reference Guide](#)

English

Product Environmental Compliance

[MD_9-160313-2_11112016215_dmtec](#)

English

[MD_9-160313-2_11112016215_dmtec](#)

English