

KUEP-3D15-125 ✓ ACTIVE

Potter & Brumfield | Potter & Brumfield KUEP

TE Internal #: 9-1393113-9

Power Relays, Industrial Panel Plug-In, Monostable, DC, 1200 mW
Coil Power Rating DC, 13000 Ω Coil Resistance, Potter & Brumfield
KUEP

[View on TE.com >](#)



Relays, Contactors & Switches > Relays > Power Relays



Power Relay Type: **Industrial Panel Plug-In**

Coil Magnetic System: **Monostable, DC**

Coil Power Rating DC: **1200 mW**

Coil Resistance: **13000 Ω**

Coil Special Features: **UL Coil Insulation Class B**

Features

Product Type Features

Power Relay Type	Industrial Panel Plug-In
------------------	--------------------------

Electrical Characteristics

Insulation Initial Dielectric Between Coil & Contact Class	1500 – 2500 V
Insulation Initial Dielectric Between Contacts & Coil	2200 Vrms
Actuating System	DC
Insulation Initial Dielectric Between Open Contacts	1200 Vrms
Contact Limiting Making Current	10 A
Contact Limiting Short-Time Current	10 A
Contact Limiting Continuous Current	10 A
Coil Power Rating Class	1000 – 1500 mW
Insulation Initial Dielectric Between Adjacent Contacts	2200 Vrms
Insulation Initial Resistance	100 M Ω
Contact Limiting Breaking Current	10 A
Coil Magnetic System	Monostable, DC
Coil Power Rating DC	1200 mW
Coil Resistance	13000 Ω
Coil Special Features	UL Coil Insulation Class B
Coil Voltage Rating	125 VDC

Contact Switching Load (Min)	300mA @ 12V
------------------------------	-------------

Contact Voltage Rating	150 VDC
------------------------	---------

Body Features

Product Weight	85 g[2.988 oz]
----------------	----------------

Contact Features

Contact Special Features	Magnetic Blowout
--------------------------	------------------

Contact Arrangement	1 Form X (NO, Bridging)
---------------------	-------------------------

Contact Current Class	5 – 10 A, 16 A
-----------------------	----------------

Contact Current Rating (Max)	10 A
------------------------------	------

Contact Material	AgCdO
------------------	-------

Contact Number of Poles	1
-------------------------	---

Relay Terminal Type	Quick Connect, Solder
---------------------	-----------------------

Mechanical Attachment

Relay Mounting Type	Socket
---------------------	--------

Dimensions

Length Class (Mechanical)	35 – 40 mm
---------------------------	------------

Height Class (Mechanical)	40 – 50 mm
---------------------------	------------

Width Class (Mechanical)	30 – 40 mm
--------------------------	------------

Product Width	35.7 mm[1.405 in]
---------------	-------------------

Product Length	38.9 mm[1.53 in]
----------------	------------------

Product Height	48.4 mm[1.905 in]
----------------	-------------------

Usage Conditions

Environmental Ambient Temperature Class	50 – 70 °C
---	------------

Environmental Ambient Temperature (Max)	70 °C[158 °F]
---	---------------

Operating Temperature Range	-45 – 70 °C
-----------------------------	-------------

Packaging Features

Packaging Method	Package
------------------	---------

Product Compliance

For compliance documentation, visit the product page on [TE.com](https://www.te.com)>

EU RoHS Directive 2011/65/EU	Compliant with Exemptions
------------------------------	---------------------------

EU ELV Directive 2000/53/EC	Not Compliant
-----------------------------	---------------







China RoHS 2 Directive MIIT Order No 32, 2016	Restricted Materials Above Threshold
EU REACH Regulation (EC) No. 1907/2006	Current ECHA Candidate List: JUNE 2023 (235) Candidate List Declared Against: JAN 2023 (233) SVHC > Threshold: Cadmium oxide (3.76% in Component Part) Article Safe Usage Statements: Use personal protective equipment as required. Do not eat, drink or smoke when using this product. Recycle if possible and dispose of the article by following all applicable governmental regulations relevant to your geographic location.
Halogen Content	Low Halogen - Br, Cl, F, I < 900 ppm per homogenous material. Also BFR/CFR/PVC Free
Solder Process Capability	Not applicable for solder process capability

Product Compliance Disclaimer

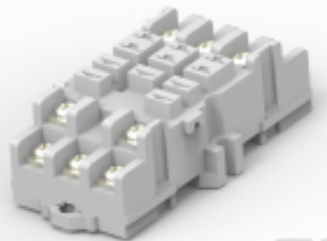
This information is provided based on reasonable inquiry of our suppliers and represents our current actual knowledge based on the information they provided. This information is subject to change. The part numbers that TE has identified as EU RoHS compliant have a maximum concentration of 0.1% by weight in homogenous materials for lead, hexavalent chromium, mercury, PBB, PBDE, DBP, BBP, DEHP, DIBP, and 0.01% for cadmium, or qualify for an exemption to these limits as defined in the Annexes of Directive 2011/65/EU (RoHS2). Finished electrical and electronic equipment products will be CE marked as required by Directive 2011/65/EU. Components may not be CE marked. Additionally, the part numbers that TE has identified as EU ELV compliant have a maximum concentration of 0.1% by weight in homogenous materials for lead, hexavalent chromium, and mercury, and 0.01% for cadmium, or qualify for an exemption to these limits as defined in the Annexes of Directive 2000/53/EC (ELV). Regarding the REACH Regulation, the information TE provides on SVHC in articles for this part number is based on the latest European Chemicals Agency (ECHA) 'Guidance on requirements for substances in articles' posted at this URL: <https://echa.europa.eu/guidance-documents/guidance-on-reach>

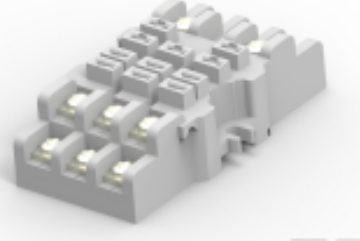
Compatible Parts

 <p>TE Part # 2-1419106-5 27E893=SOCKET,KU,11,QC,POLY,NA-</p>	 <p>TE Part # 1419106-4 27E046=SOCKET,KU,11,PC,NYL,NAT</p>	 <p>TE Part # 1393143-1 27E043=SOCKET,KU,11,SLG,NYL,N</p>	 <p>TE Part # 1393143-5 27E121=SOCKET,KUP,11,SCW,PLE</p>
 <p>TE Part # 1393143-2 27E067=SOCKET,KU,11,QC.187,NY</p>	 <p>TE Part # 3-1393143-8 27E396=SOCKETS</p>		

Also in the Series | Potter & Brumfield KUEP



Power Relays(30)

Customers Also Bought



TE Part #2-321233-1
TERMINAL,PIDG SPD 16-14 8



TE Part #66597-8
III+ PIN,18-14,TIN ,STRIP

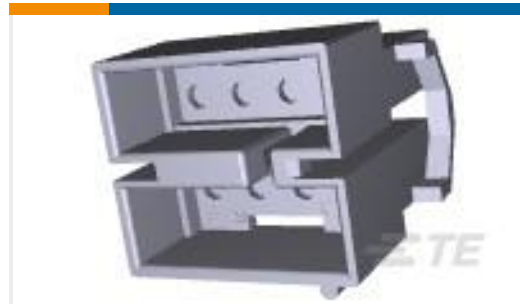

TE Part #1-480284-0
08P CMNL CAP HSG M/M NATL



TE Part #1-480286-0
10P CMNL CAP HSG M/M NATL



TE Part #8-1393113-3
KUEP-11A15-120=RELAY,GENPUR,OC



TE Part #828296-3
3P MOD 2 STIFT LEI



TE Part #5-1625890-0
2W SM M/OX 5% 470K



TE Part #2-1437661-9
TC6-03-PFH=COVER w/HOLES



TE Part #3-1879355-7
RR03 5% 130K AMMO



TE Part #4-1393104-4
KRPA-11DG-125=KRPA

Documents

CAD Files

[3D PDF](#)

[3D](#)

Customer View Model

[ENG_CVM_CVM_9-1393113-9_D.2d_dxf.zip](#)

English

Customer View Model

[ENG_CVM_CVM_9-1393113-9_D.3d_igs.zip](#)



English

Customer View Model

[ENG_CVM_CVM_9-1393113-9_D.3d_stp.zip](#)

English

By downloading the CAD file I accept and agree to the [Terms and Conditions](#) of use.

Datasheets & Catalog Pages

[KUEP Series Relay Datasheet](#)

English

Product Specifications

[Definitions General Purpose Relays](#)

English

Agency Approvals

[UL](#)

English