

881623-1 ✓ ACTIVE

FASTON | FASTON 187

TE Internal #: 881623-1

Quick Disconnects, Receptacle, 20 – 17 AWG Wire Size, .51 – 1.03 mm² Wire Size, Mating Tab Width 4.75 mm [.187 in], Straight, Brass, FASTON 187

[View on TE.com >](#)



Terminals & Splices > Quick Disconnects

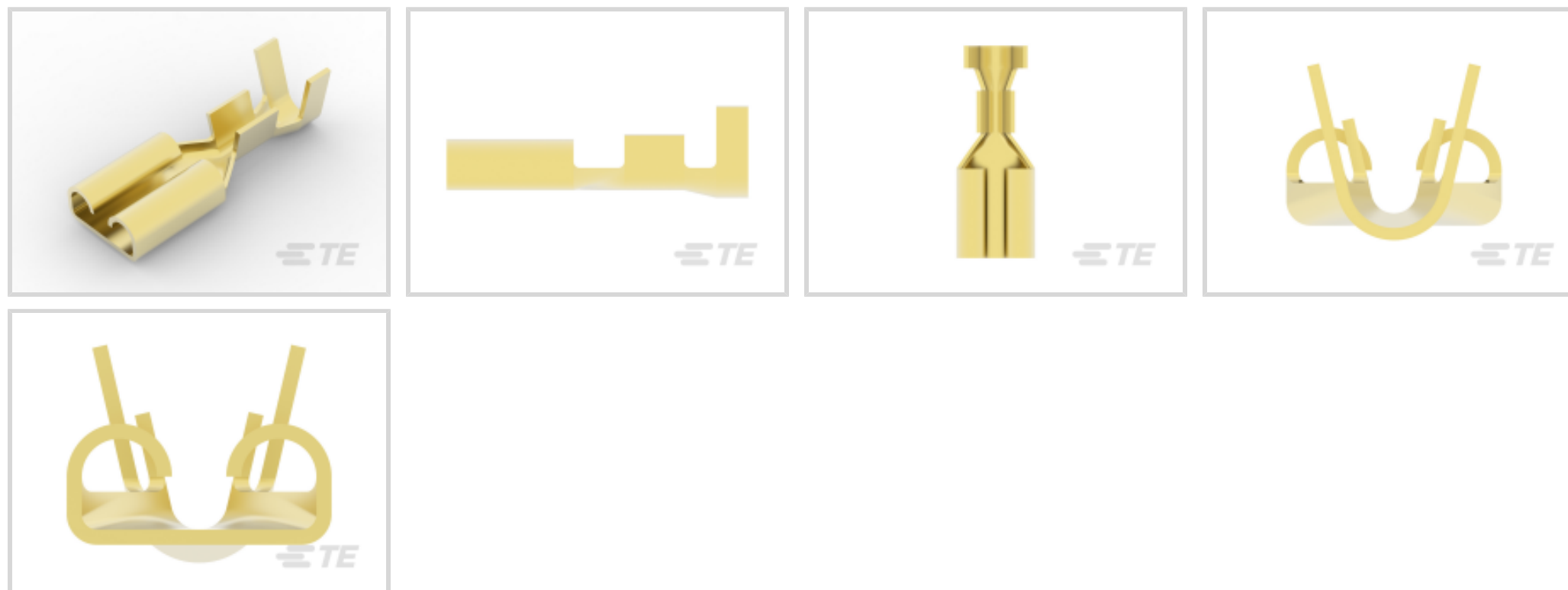

Quick Disconnect Terminal Type: **Receptacle**

Wire Size: .51 – 1.03 mm²

Mating Tab Width: 4.75 mm [.187 in]

Mating Tab Thickness: .81 mm [.032 in]

Features

Product Type Features

| | |
|-----------------|--------|
| Insertion Force | Normal |
|-----------------|--------|

Configuration Features

| | |
|-----------------------------------|---------------|
| Compatible With Wire & Cable Type | Discrete Wire |
|-----------------------------------|---------------|

Contact Features

| | |
|--------------------------------|-------------------|
| Quick Disconnect Terminal Type | Receptacle |
| Mating Tab Width | 4.75 mm [.187 in] |
| Mating Tab Thickness | .81 mm [.032 in] |
| Terminal Orientation | Straight |
| Contact Base Material | Brass |
| Terminal Plating Material | Unplated |
| Crimp Type | F-Crimp |
| Barrel Type | Open |

Termination Features

| | |
|-----------------------|--------------|
| Product Terminates To | Wire & Cable |
|-----------------------|--------------|



Mechanical Attachment

| | |
|-------------------------|--------|
| Wire Insulation Support | With |
| Mating Retention Type | Dimple |

Dimensions

| | |
|--------------------------------------|------------------------------|
| Terminal Material Thickness | .3 mm[.012 in] |
| Product Length | 15.1 mm[.594 in] |
| Compatible Insulation Diameter Range | 2.01 – 3.3 mm[.079 – .13 in] |
| Wire Size | .51 – 1.03 mm ² |

Usage Conditions

| | |
|-----------------------------|----------------------------|
| Insulation Option | Uninsulated |
| Operating Temperature Range | -40 – 110 °C[-40 – 230 °F] |

Industry Standards

| | |
|-----------------|----|
| Agency/Standard | UL |
|-----------------|----|

Packaging Features

| | |
|--------------------|------------|
| Packaging Quantity | 15000 |
| Packaging Method | Strip/Reel |

Product Compliance

[For compliance documentation, visit the product page on TE.com>](#)

| | |
|---|---|
| EU RoHS Directive 2011/65/EU | Compliant |
| EU ELV Directive 2000/53/EC | Compliant |
| China RoHS 2 Directive MIIT Order No 32, 2016 | No Restricted Materials Above Threshold |
| EU REACH Regulation (EC) No. 1907/2006 | Current ECHA Candidate List: JUNE 2023 (235) Candidate List Declared Against: JUNE 2023 (235) Does not contain REACH SVHC |
| Halogen Content | Low Halogen - Br, Cl, F, I < 900 ppm per homogenous material. Also BFR/CFR/PVC Free |
| Solder Process Capability | Not applicable for solder process capability |

Product Compliance Disclaimer

This information is provided based on reasonable inquiry of our suppliers and represents our current actual knowledge based on the information they provided. This information is subject to change. The part numbers that TE has identified as EU RoHS compliant have a maximum concentration of 0.1% by weight in homogenous materials for lead, hexavalent chromium, mercury, PBB, PBDE, DBP, BBP, DEHP, DIBP, and 0.01% for cadmium, or qualify for an exemption to these

limits as defined in the Annexes of Directive 2011/65/EU (RoHS2). Finished electrical and electronic equipment products will be CE marked as required by Directive 2011/65/EU. Components may not be CE marked. Additionally, the part numbers that TE has identified as EU ELV compliant have a maximum concentration of 0.1% by weight in homogenous materials for lead, hexavalent chromium, and mercury, and 0.01% for cadmium, or qualify for an exemption to these limits as defined in the Annexes of Directive 2000/53/EC (ELV). Regarding the REACH Regulation, the information TE provides on SVHC in articles for this part number is based on the latest European Chemicals Agency (ECHA) 'Guidance on requirements for substances in articles' posted at this URL: <https://echa.europa.eu/guidance-documents/guidance-on-reach>

Compatible Parts



TE Part # 880488-2
187 FASTON HSG. REC. 1P NATURAL



TE Part # 1-880488-1
FASTON 187 HOUSING RECEPTACLE



TE Part # 880488-1
FASTON 187 HSG REC BLACK/PRETO



TE Part # 1-880488-2
FASTON 187 HOUSING RECEPTACLE



TE Part # 1-2133394-1
187 FASTON HSG.,REC.,1 POS, NATURAL



TE Part # 1-2133394-2
187 FASTON HSG.,REC.,1 POS, BLACK



TE Part # 1-2133394-3
187 FASTON HSG.,REC.,1 POS, RED



TE Part # 1-880488-4
FASTON 187 HOUSING RECEPTACLE



TE Part # 1-880488-5
FASTON 187 HOUSING RECEPTACLE



TE Part # 2-2133394-1
187 FASTON HSG.,REC.,1 POS, NATURAL



TE Part # 2-2150279-1
OCEAN_2.0_Applicator-E-080F130F



TE Part # 2-2150279-2
OCEAN_2.0_Applicator-E-080F130F



TE Part # 2-880488-1
FASTON 187 HOUSING RECEPTACLE



TE Part # 2-880488-2
.187 S FASTON RECEPTACLE HSG



TE Part # 2150279-1
OCEAN_2.0_Applicator-E-080F130F



TE Part # 2150279-2
OCEAN_2.0_Applicator-E-080F130F



Also in the Series | FASTON 187

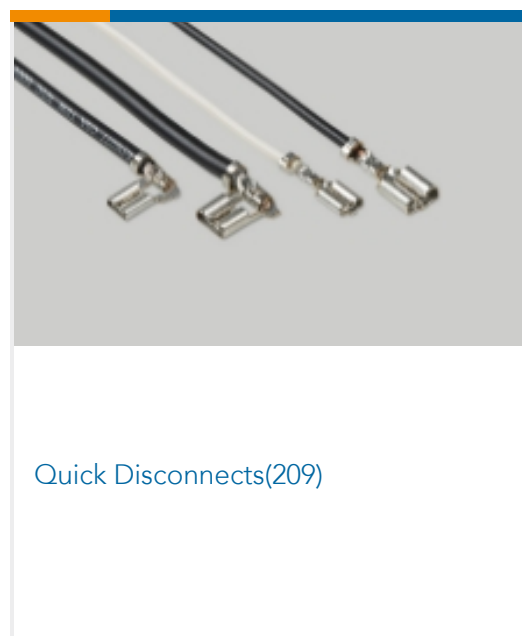
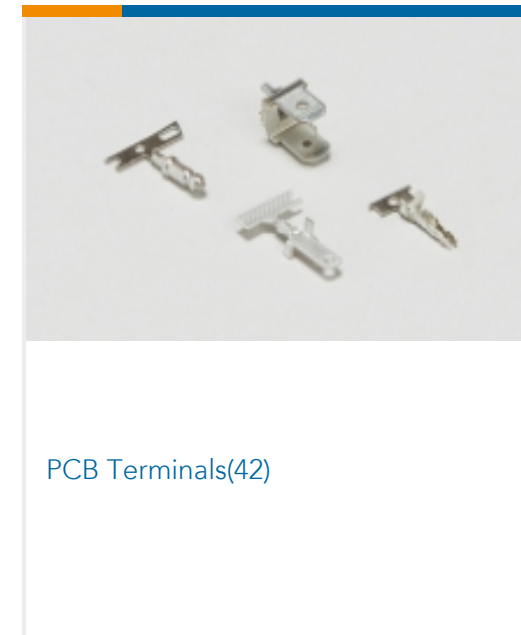
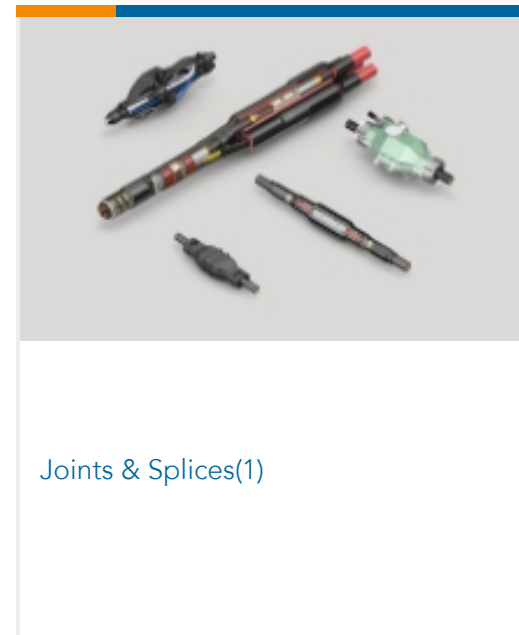
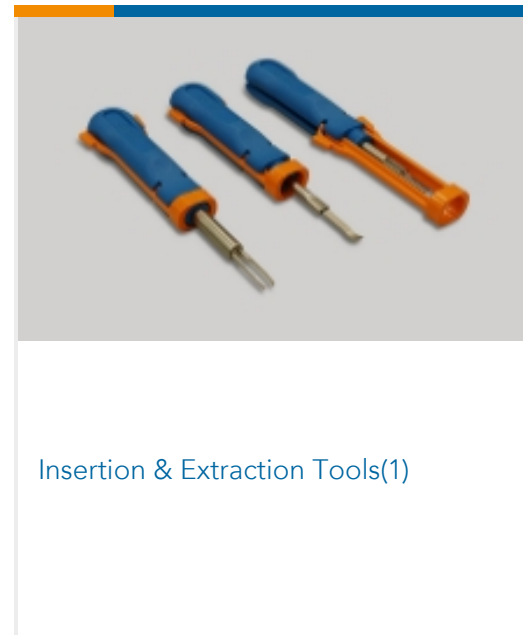
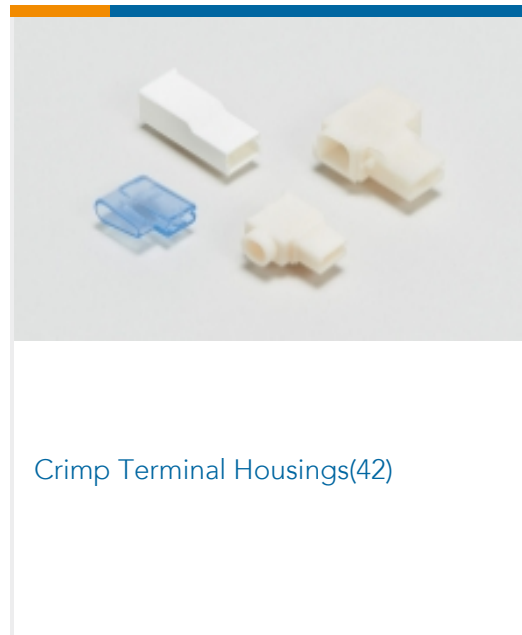

Customers Also Bought

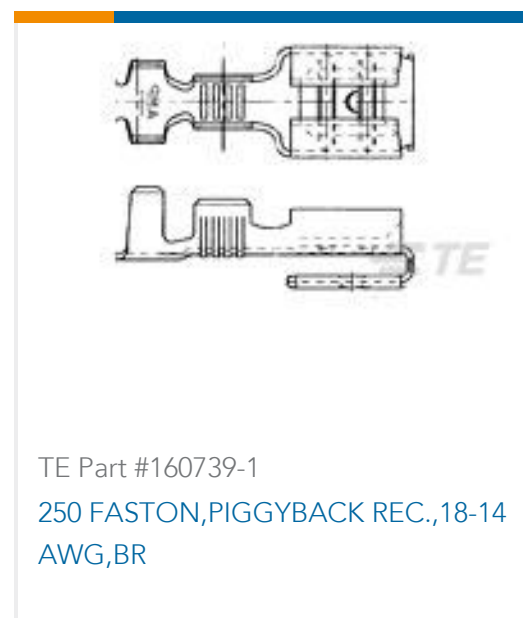



Documents

Product Drawings

[187 FASTON REC 20-17 AWG BR](#)

English

CAD Files

[3D PDF](#)

3D

Customer View Model

[ENG_CVM_CVM_881623-1_P.2d_dxf.zip](#)

English

Customer View Model

[ENG_CVM_CVM_881623-1_P.3d_igs.zip](#)

English

Customer View Model

[ENG_CVM_CVM_881623-1_P.3d_stp.zip](#)

English

By downloading the CAD file I accept and agree to the [Terms and Conditions](#) of use.

Product Specifications

[EB**General Application Specification for Open Barrel Terminals](#)

English

[Application Specification](#)

English

Product Environmental Compliance

[MD_881623-1_0915201710_dmtec](#)

English

[MD_881623-1_0915201710_dmtec](#)

English