



Positive Lock | Mark I, Positive Lock 250

TE Internal #: 880645-6

Quick Disconnects, Receptacle, 17 – 13 AWG Wire Size, 1.03 – 2.62 mm<sup>2</sup> Wire Size, Mating Tab Width 6.35 mm [.25 in], Straight, Brass, Positive Lock 250

[View on TE.com >](#)

Terminals & Splices > Quick Disconnects



Quick Disconnect Terminal Type: **Receptacle**

Wire Size: 1.03 – 2.62 mm<sup>2</sup>

Mating Tab Width: 6.35 mm [.25 in]

Mating Tab Thickness: .81 mm [.032 in]

### Features

#### Product Type Features

Insertion Force	Low
-----------------	-----

#### Configuration Features

Compatible With Wire & Cable Type	Discrete Wire
-----------------------------------	---------------

#### Contact Features

Quick Disconnect Terminal Type	Receptacle
Mating Tab Width	6.35 mm [.25 in]
Mating Tab Thickness	.81 mm [.032 in]
Terminal Orientation	Straight
Contact Base Material	Brass
Terminal Plating Material	Pre-Tin
Crimp Type	F-Crimp
Barrel Type	Open

#### Termination Features

Product Terminates To	Wire & Cable
-----------------------	--------------



### Mechanical Attachment

Wire Insulation Support	With
Mating Retention Type	Dimple

### Dimensions

Terminal Material Thickness	.41 mm[.016 in]
Product Length	21.3 mm[.838 in]
Compatible Insulation Diameter Range	2.7 – 4 mm[.106 – .157 in]
Wire Size	1.03 – 2.62 mm <sup>2</sup>

### Usage Conditions

Insulation Option	Uninsulated
-------------------	-------------

### Industry Standards

Agency/Standard	UL
-----------------	----

### Packaging Features

Packaging Quantity	1300
Packaging Method	Reel

### Product Compliance

[For compliance documentation, visit the product page on TE.com>](#)

EU RoHS Directive 2011/65/EU	Compliant
EU ELV Directive 2000/53/EC	Compliant
China RoHS 2 Directive MIIT Order No 32, 2016	No Restricted Materials Above Threshold
EU REACH Regulation (EC) No. 1907/2006	Current ECHA Candidate List: JUNE 2023 (235) Candidate List Declared Against: JUNE 2023 (235) Does not contain REACH SVHC
Halogen Content	Low Halogen - Br, Cl, F, I < 900 ppm per homogenous material. Also BFR/CFR/PVC Free
Solder Process Capability	Not applicable for solder process capability

#### Product Compliance Disclaimer

This information is provided based on reasonable inquiry of our suppliers and represents our current actual knowledge based on the information they provided. This information is subject to change. The part numbers that TE has identified as EU RoHS compliant have a maximum concentration of 0.1% by weight in homogenous materials for lead, hexavalent chromium, mercury, PBB, PBDE, DBP, BBP, DEHP, DIBP, and 0.01% for cadmium, or qualify for an exemption to these limits as defined in the Annexes of Directive 2011/65/EU (RoHS2). Finished electrical and electronic equipment products will be CE marked as required by Directive 2011/65/EU. Components may not be CE marked. Additionally, the part

numbers that TE has identified as EU ELV compliant have a maximum concentration of 0.1% by weight in homogenous materials for lead, hexavalent chromium, and mercury, and 0.01% for cadmium, or qualify for an exemption to these limits as defined in the Annexes of Directive 2000/53/EC (ELV). Regarding the REACH Regulation, the information TE provides on SVHC in articles for this part number is based on the latest European Chemicals Agency (ECHA) 'Guidance on requirements for substances in articles' posted at this URL: <https://echa.europa.eu/guidance-documents/guidance-on-reach>

## Compatible Parts



## Also in the Series | Mark I

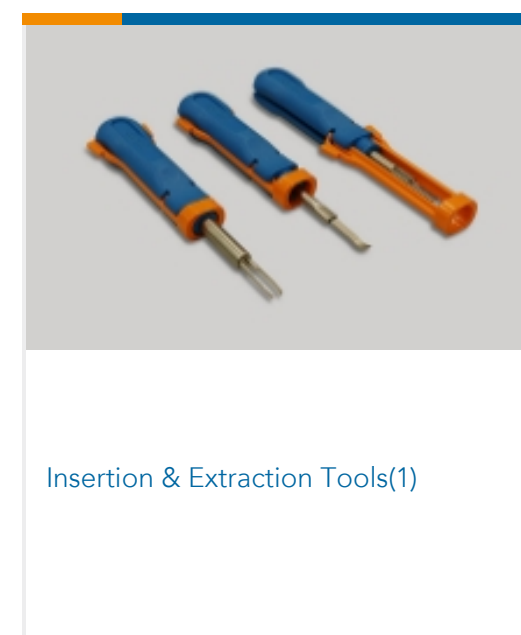
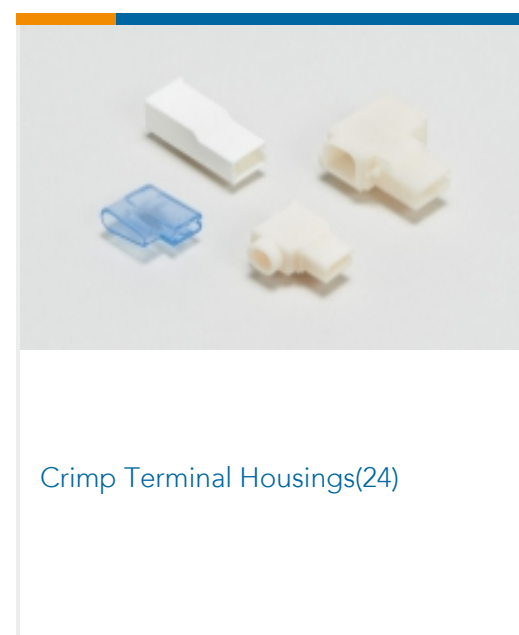
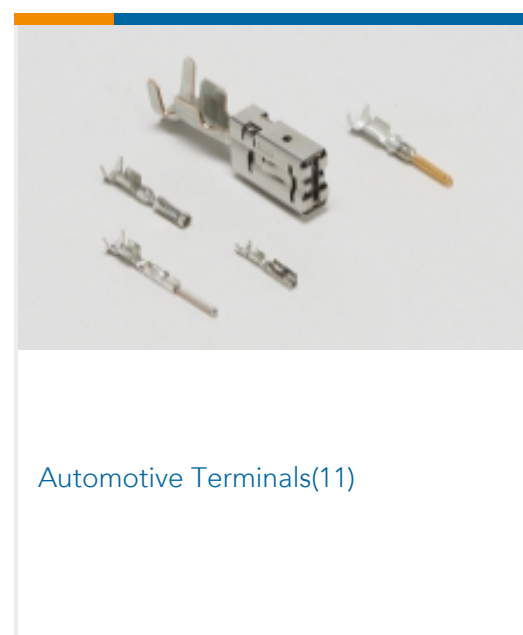
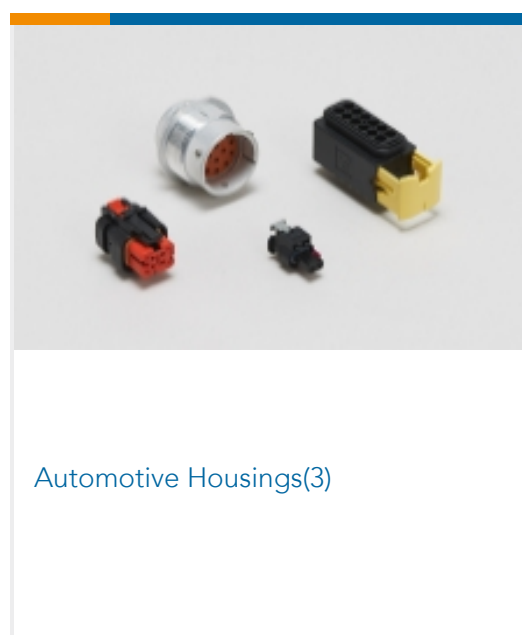



Quick Disconnects(29)

Also in the Series | Positive Lock 250



Automotive Terminals(1)



Crimp Terminal Housings(193)



Insertion & Extraction Tools(3)



Insulation Boots & Sleeves(4)

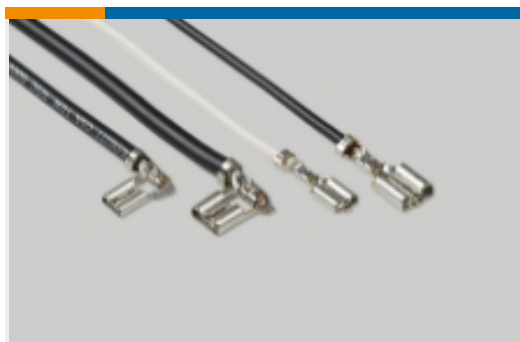

Quick Disconnects(186)

Customers Also Bought

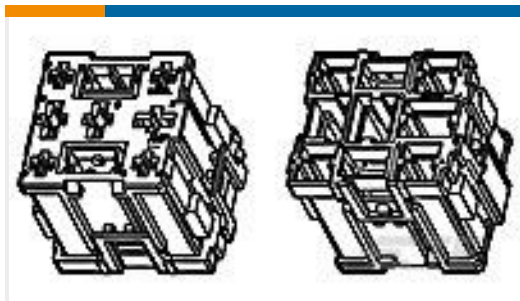

TE Part #444017-1  
HSG ASS'Y 9 POS JR

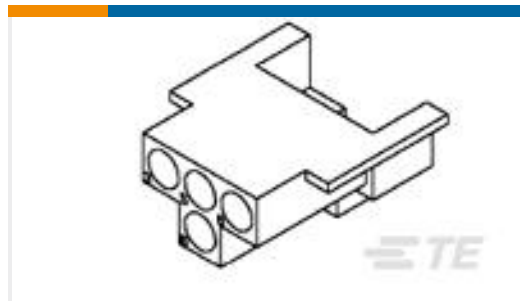

TE Part #880125  
9 CIR CAP 140DIA PANEL MT NAT



TE Part #880310-1  
2 WAY FF 250 HOUSING TAB NYLON 6.6 NAT



TE Part #880636-2  
FF 250 TAB 1.0-2.5 MM2 0.39 X 13.2 TPBR

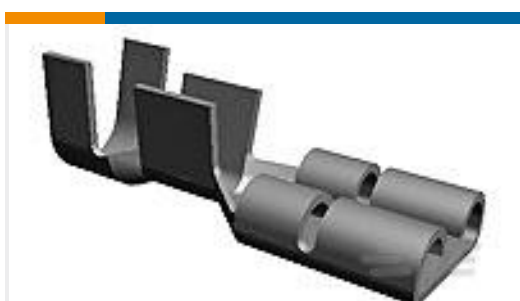

TE Part #444334-2  
250 FASTON REC 22-18 AWG TPBR



TE Part #626581-1  
PL 250 REC 0.5-1.5 MM2 0.35X 26.54 BR



TE Part #1-2133341-1  
PL MK1 RECEPTACLE NATURAL 6.6 PA



TE Part #881339-2  
SLEEVE FOR .250 SRS FASTON TAB





## Documents

### Product Drawings

[PL REC 1.0-2.5MM2 0.40 X 52.32 PTPBR](#)

English

### CAD Files

[3D PDF](#)

3D

Customer View Model

[ENG\\_CVM\\_CVM\\_880645-6\\_D.2d\\_dxf.zip](#)

English

Customer View Model

[ENG\\_CVM\\_CVM\\_880645-6\\_D.3d\\_igs.zip](#)

English

Customer View Model

[ENG\\_CVM\\_CVM\\_880645-6\\_D.3d\\_stp.zip](#)

English

By downloading the CAD file I accept and agree to the [Terms and Conditions](#) of use.

### Product Specifications

[Application Specification](#)

English