

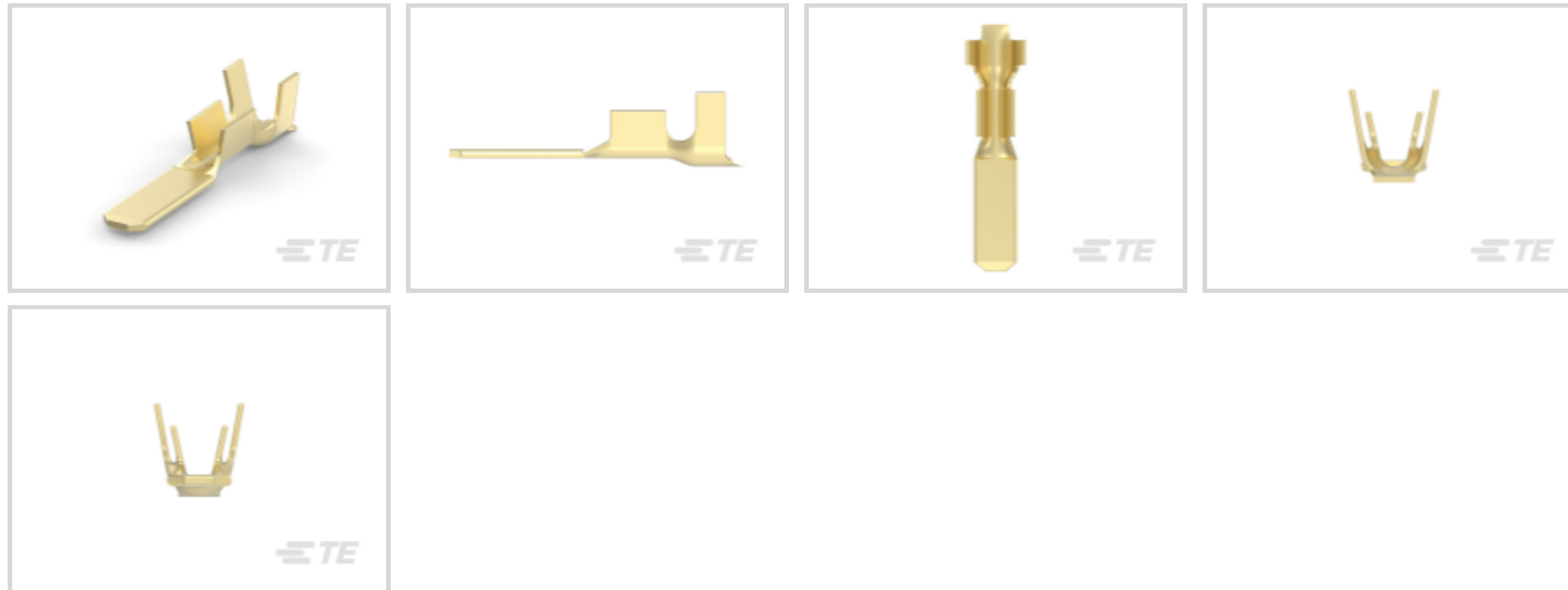

Terminals & Splices > Quick Disconnects



Quick Disconnect Terminal Type: **Tab**

Wire Size: **.51 – 1.03 mm²**

Terminal Orientation: **Straight**

Contact Base Material: **Brass**

Features

Configuration Features

Compatible With Wire & Cable Type	Discrete Wire
-----------------------------------	---------------

Contact Features

Quick Disconnect Terminal Type	Tab
Terminal Orientation	Straight
Contact Base Material	Brass
Terminal Plating Material	Unplated
Crimp Type	F-Crimp
Barrel Type	Open

Mechanical Attachment

Wire Insulation Support	With
-------------------------	------

Dimensions

Terminal Material Thickness	.5 mm [.019 in]
Compatible Insulation Diameter Range	2.03 – 2.54 mm [.08 – .1 in]
Wire Size	.51 – 1.03 mm ²



Usage Conditions

Insulation Option	Uninsulated
Operating Temperature Range	-40 – 110 °C[-40 – 230 °F]

Packaging Features

Packaging Quantity	20000
Packaging Method	Strip/Reel

Product Compliance

[For compliance documentation, visit the product page on TE.com>](#)

EU RoHS Directive 2011/65/EU	Compliant
EU ELV Directive 2000/53/EC	Compliant
China RoHS 2 Directive MIIT Order No 32, 2016	No Restricted Materials Above Threshold
EU REACH Regulation (EC) No. 1907/2006	Current ECHA Candidate List: JUNE 2023 (235) Candidate List Declared Against: JUNE 2022 (224) Does not contain REACH SVHC
Halogen Content	Low Halogen - Br, Cl, F, I < 900 ppm per homogenous material. Also BFR/CFR/PVC Free
Solder Process Capability	Not applicable for solder process capability

Product Compliance Disclaimer

This information is provided based on reasonable inquiry of our suppliers and represents our current actual knowledge based on the information they provided. This information is subject to change. The part numbers that TE has identified as EU RoHS compliant have a maximum concentration of 0.1% by weight in homogenous materials for lead, hexavalent chromium, mercury, PBB, PBDE, DBP, BBP, DEHP, DIBP, and 0.01% for cadmium, or qualify for an exemption to these limits as defined in the Annexes of Directive 2011/65/EU (RoHS2). Finished electrical and electronic equipment products will be CE marked as required by Directive 2011/65/EU. Components may not be CE marked. Additionally, the part numbers that TE has identified as EU ELV compliant have a maximum concentration of 0.1% by weight in homogenous materials for lead, hexavalent chromium, and mercury, and 0.01% for cadmium, or qualify for an exemption to these limits as defined in the Annexes of Directive 2000/53/EC (ELV). Regarding the REACH Regulation, the information TE provides on SVHC in articles for this part number is based on the latest European Chemicals Agency (ECHA) 'Guidance on requirements for substances in articles' posted at this URL: <https://echa.europa.eu/guidance-documents/guidance-on-reach>

Compatible Parts



TE Part # 2-2150986-1
OCEAN-2.0-APPLICATOR-E-080F110F



TE Part # 2-2150986-2
OCEAN-2.0-APPLICATOR-E-080F110FA



TE Part # 2150986-1
OCEAN-2.0-APPLICATOR-E-080F110F



TE Part # 2150986-2
OCEAN-2.0-APPLICATOR-E-080F110FA



TE Part # 7-2150986-1
OCEAN-2.0-APPLICATOR-E-080F110F



TE Part # 7-2150986-2
OCEAN-2.0-APPLICATOR-E-080F110FA



TE Part # 7-2150986-7
OCEAN_2.0_SPARE_PART_KIT-080F110F

Also in the Series | **FASTON 110**



Crimp Terminal Housings(13)



Insertion & Extraction Tools(1)



PCB Terminals(21)

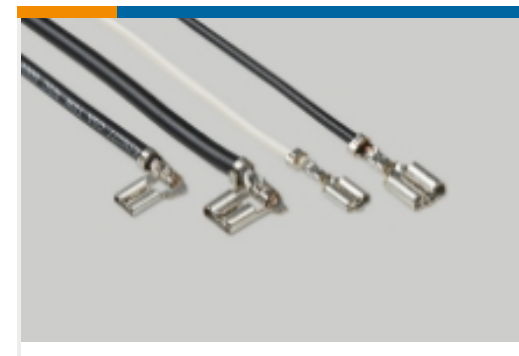

Quick Disconnects(171)

Customers Also Bought

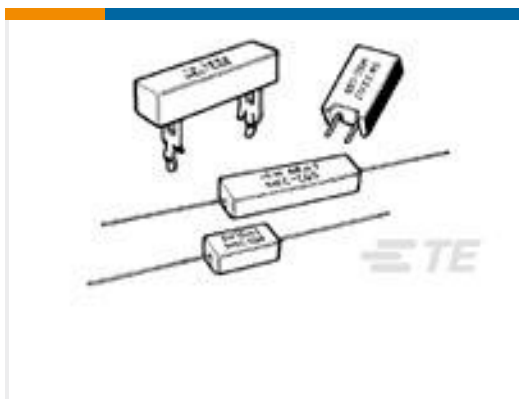

TE Part #1623804-1
SQZ10 15R 5% WIRE

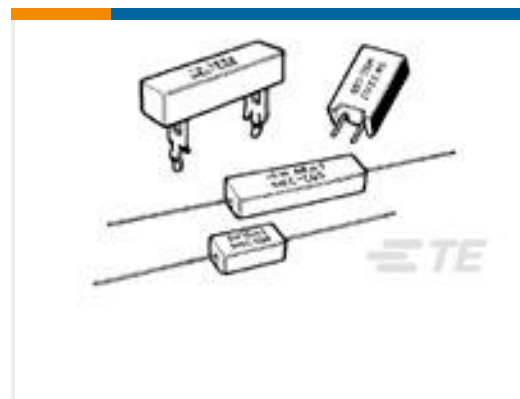

TE Part #1623797-1
SQZ10 10R 5%



TE Part #880645-6
PL REC 1.0-2.5MM2 0.40 X 52.32 PTPBR



TE Part #8-1624112-5
3650 0603 72nH 5% 2K RL



TE Part #5-2232362-3
PTL MFBL 1X3 PLUG HSG GLW WIRE NAT



TE Part #7-1611011-4
3100-30U9999CY=30A 3P 208/240V



TE Part #1-2133394-1
187 FASTON HSG.,REC.,1 POS, NATRUAL



Documents

Product Drawings

[110 FASTON REC 20-17 AWG BR](#)

English

CAD Files

[3D PDF](#)

3D

Customer View Model

[ENG_CVM_CVM_880633-1_J.2d_dxf.zip](#)

English

Customer View Model

[ENG_CVM_CVM_880633-1_J.3d_igs.zip](#)

English

Customer View Model

[ENG_CVM_CVM_880633-1_J.3d_stp.zip](#)

English

By downloading the CAD file I accept and agree to the [Terms and Conditions](#) of use.

Product Environmental Compliance

[Product Compliance](#)

English

[Product Compliance](#)

English