

880125 ✓ ACTIVE

MATE-N-LOK | Commercial MATE-N-LOK

TE Internal #: 880125

Rectangular Connector Housings, Wire-to-Wire, 9 Position, .24 in [6.1 mm] Centerline, 3 Row, Nylon GF, Receptacle, Pin, Commercial MATE-N-LOK

[View on TE.com >](#)



Connectors > Rectangular Connectors > Rectangular Connector Housings

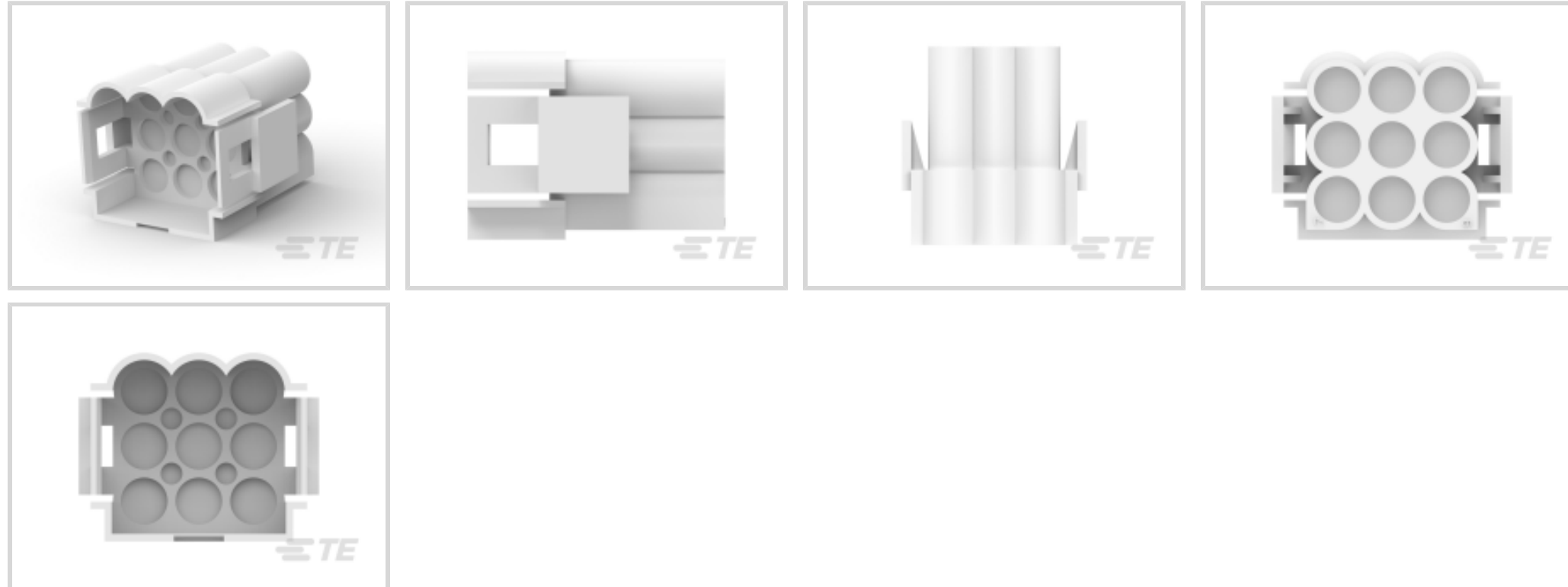

Connector System: **Wire-to-Wire**

Number of Positions: **9**

Centerline (Pitch): **6.1 mm [.24 in]**

Number of Rows: **3**

Housing Material: **Nylon GF**

Features

Product Type Features

Connector System	Wire-to-Wire
Connector & Housing Type	Receptacle
Sealable	No
Connector & Contact Terminates To	Wire & Cable

Configuration Features

Number of Positions	9
Number of Rows	3

Electrical Characteristics

Operating Voltage	250 VAC
-------------------	---------

Contact Features

Contact Layout	Matrix
Contact Type	Pin

Mechanical Attachment



Connector Mounting Type	Cable Mount (Free-Hanging)
-------------------------	----------------------------

Housing Features

Housing Color	Natural
Centerline (Pitch)	6.1 mm [.24 in]
Housing Material	Nylon GF

Dimensions

Connector Height	26.8 mm
Product Width	20.93 mm
Product Length	28.7 mm
Row-to-Row Spacing	3.1 mm [.24 in]

Usage Conditions

Operating Temperature Range	-55 – 105 °C [-67 – 221 °F]
-----------------------------	-----------------------------

Operation/Application

Circuit Application	Power
---------------------	-------

Identification Marking

Circuit Identification Feature	With
--------------------------------	------

Industry Standards

Agency/Standard	UL
Approved Standards	UL E28476
UL Flammability Rating	UL 94V-2

Packaging Features

Packaging Quantity	1400
Packaging Method	Box

Product Compliance

[For compliance documentation, visit the product page on TE.com>](#)

EU RoHS Directive 2011/65/EU	Compliant
EU ELV Directive 2000/53/EC	Compliant
China RoHS 2 Directive MIIT Order No 32, 2016	No Restricted Materials Above Threshold
EU REACH Regulation (EC) No. 1907/2006	Current ECHA Candidate List: JUNE 2023 (235) Candidate List Declared Against: JUNE 2023 (235)



Does not contain REACH SVHC

Halogen Content

Low Halogen - Br, Cl, F, I < 900 ppm per homogenous material. Also BFR/CFR/PVC Free

Solder Process Capability

Not applicable for solder process capability

Product Compliance Disclaimer

This information is provided based on reasonable inquiry of our suppliers and represents our current actual knowledge based on the information they provided. This information is subject to change. The part numbers that TE has identified as EU RoHS compliant have a maximum concentration of 0.1% by weight in homogenous materials for lead, hexavalent chromium, mercury, PBB, PBDE, DBP, BBP, DEHP, DIBP, and 0.01% for cadmium, or qualify for an exemption to these limits as defined in the Annexes of Directive 2011/65/EU (RoHS2). Finished electrical and electronic equipment products will be CE marked as required by Directive 2011/65/EU. Components may not be CE marked. Additionally, the part numbers that TE has identified as EU ELV compliant have a maximum concentration of 0.1% by weight in homogenous materials for lead, hexavalent chromium, and mercury, and 0.01% for cadmium, or qualify for an exemption to these limits as defined in the Annexes of Directive 2000/53/EC (ELV). Regarding the REACH Regulation, the information TE provides on SVHC in articles for this part number is based on the latest European Chemicals Agency (ECHA) 'Guidance on requirements for substances in articles' posted at this URL: <https://echa.europa.eu/guidance-documents/guidance-on-reach>

Compatible Parts



TE Part # 350389-1
.140 DIA PIN 20-14 PTPBR L/P



TE Part # 1-480585-0
09P .140 MNL PLUG NAT



TE Part # 925660-2
.140 DIA PIN



TE Part # 925660-1
.140 DIA PIN



TE Part # 925715-1
M-N-L PIN TPBR



TE Part # 61627-1
.140 DIA PIN 20-14 PTPBR



TE Part # 350201-1
.140 DIA PIN 14-10 PTPBR



TE Part # 880685-2
.140 DIA PIN



TE Part # 926988-1
MNL STIFT 3,5 MM



TE Part # 925713-2
.140 DIA PIN



TE Part # 925713-1
M-N-L PIN TPBR



TE Part # 350391-1
.140 DIA PIN 14-10 PTPBR L/P



Also in the Series | Commercial MATE-N-LOK

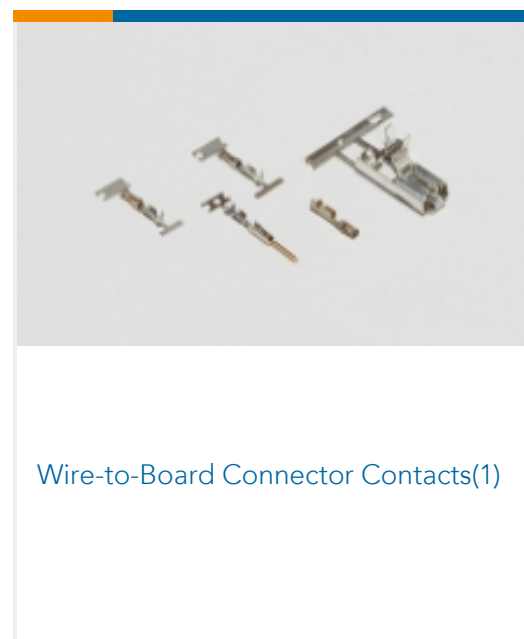
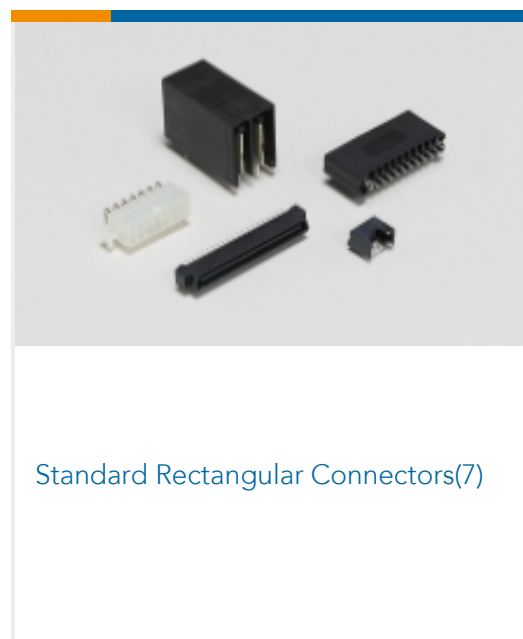
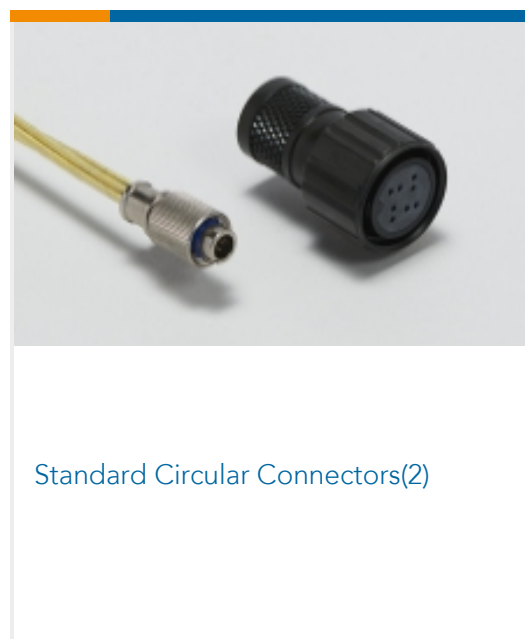
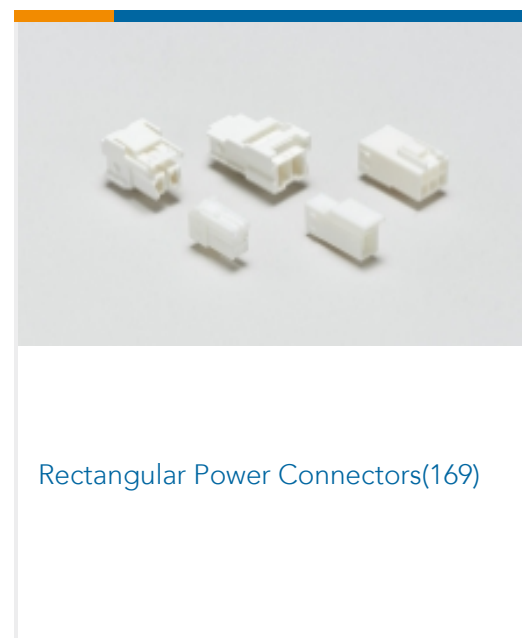
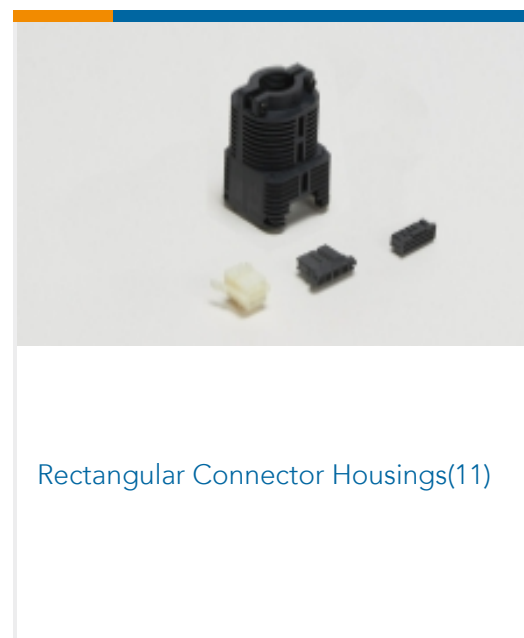
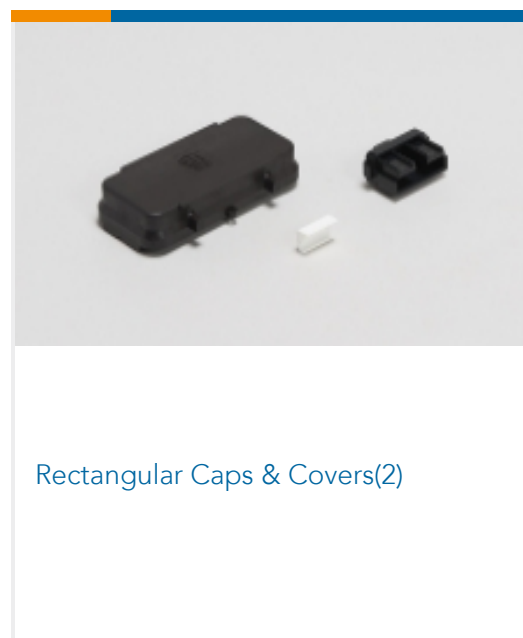
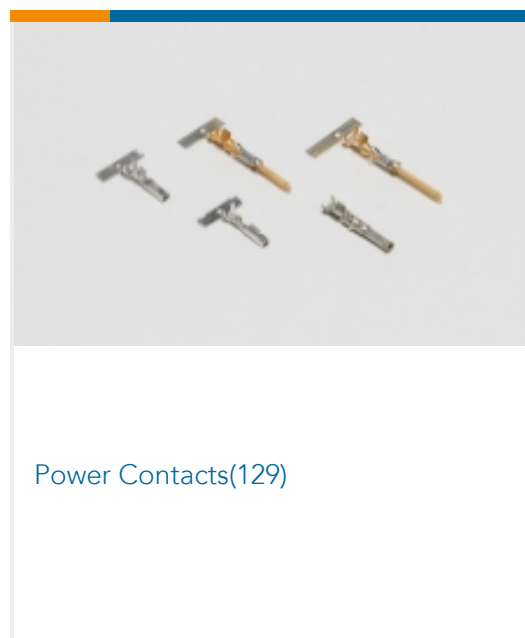
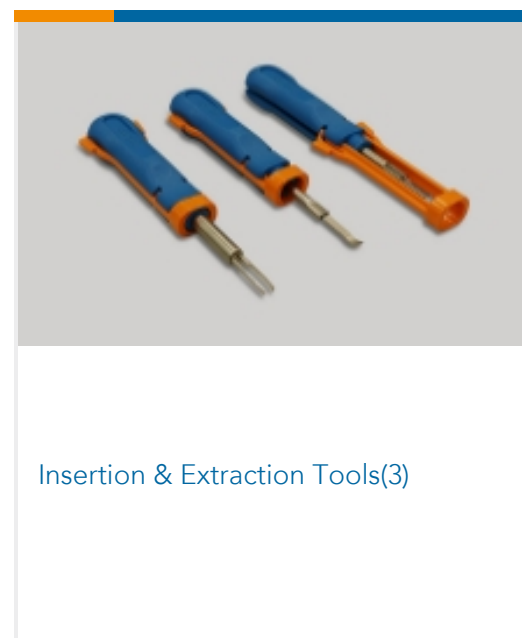
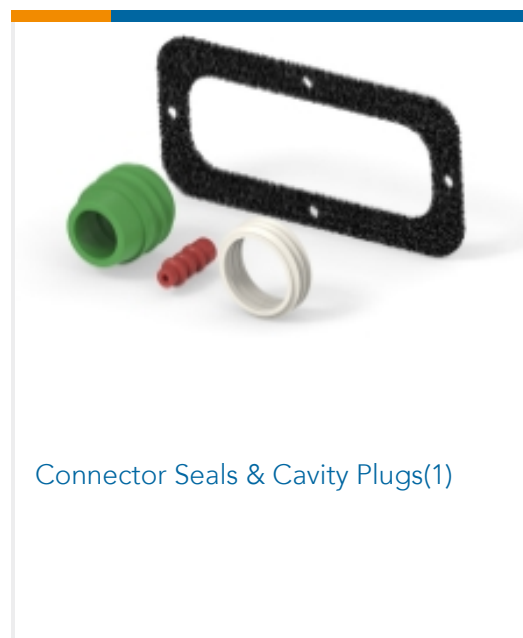
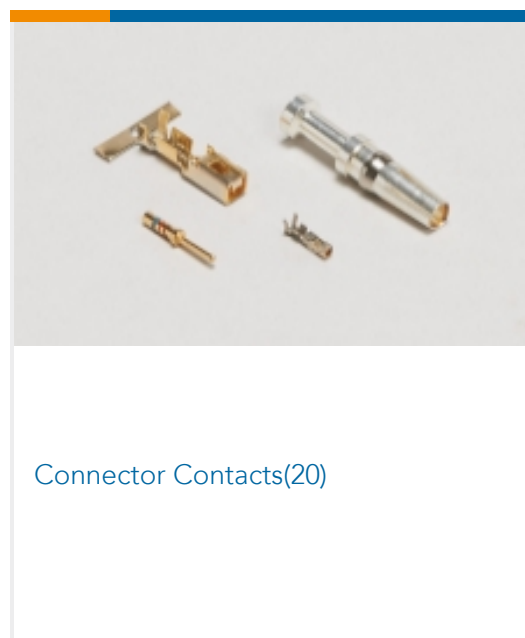

Customers Also Bought

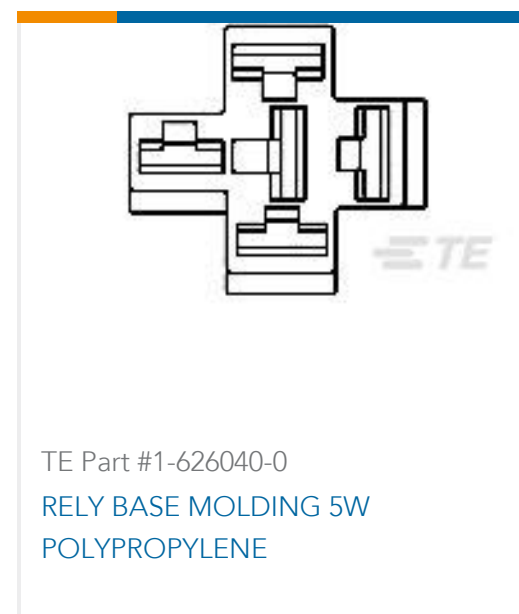
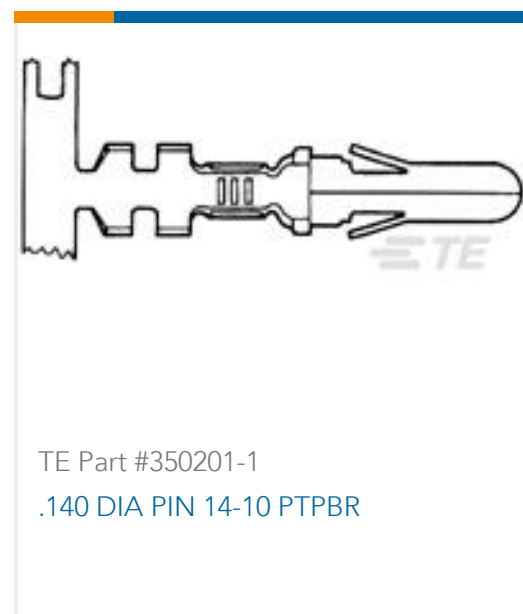

Documents

CAD Files

3D PDF

3D

Customer View Model

[ENG_CVM_CVM_880125_J.2d_dxf.zip](#)

English

Customer View Model

[ENG_CVM_CVM_880125_J.3d_igs.zip](#)

English

Customer View Model

[ENG_CVM_CVM_880125_J.3d_stp.zip](#)

English

Customer View Model

[ENG_CVM_880125_G.3d_igs.zip](#)

English

Customer View Model

[ENG_CVM_880125_G.3d_stp.zip](#)

English



Customer View Model

[ENG_CVM_880125_G.2d_dxf.zip](#)

English

[3D PDF](#)

English

By downloading the CAD file I accept and agree to the [Terms and Conditions](#) of use.

Product Specifications

[Product Specification](#)

English

Agency Approvals

[Agency Approval Document](#)

English