

87977-3 ✓ ACTIVE

AMPMODU | AMPMODU IV/V

TE Internal #: 87977-3

Housing, Receptacle, Wire-to-Board, 10 Position, .1 in [2.54 mm]
Centerline, Crimp, 2 Row, Black, Mating Retention, Wire & Cable,
Signal, AMPMODU IV/V

[View on TE.com >](#)



Connectors > PCB Connectors > Wire-to-Board Connectors > Wire-to-Board Connector Assemblies & Housings

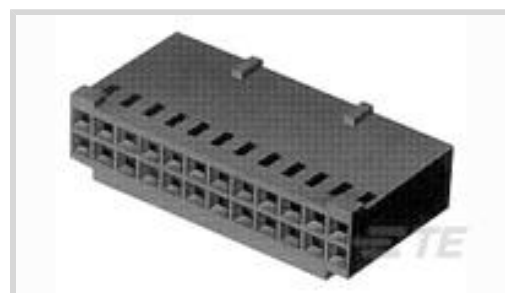

Connector Product Type: **Housing**

Connector & Housing Type: **Receptacle**

Connector System: **Wire-to-Board**

Number of Positions: **10**

Centerline (Pitch): **2.54 mm [.1 in]**

Features

Product Type Features

Connector Product Type	Housing
Connector & Housing Type	Receptacle
Connector System	Wire-to-Board
Connector & Contact Terminates To	Wire & Cable

Configuration Features

Number of Positions	10
Number of Rows	2

Electrical Characteristics

Termination Resistance	12 mΩ
Insulation Resistance	5000 MΩ
Dielectric Withstanding Voltage (Max)	750 V
Operating Voltage	250 VAC

Body Features

Primary Product Color	Black
-----------------------	-------

Contact Features

Contact Type	Socket
Contact Base Material	Beryllium Copper
Contact Current Rating (Max)	3 A



Termination Features

Termination Method to Wire & Cable	Crimp
------------------------------------	-------

Mechanical Attachment

Strain Relief	Without
Mating Retention Type	Detent Latching
Mating Retention	With

Housing Features

Housing Entry Configuration	Both Ends Closed
Housing Material	Nylon - GF
Centerline (Pitch)	2.54 mm[.1 in]

Dimensions

Connector Length	12.7 mm[.5 in]
Connector Height	6.1 mm[.24 in]
Row-to-Row Spacing	2.54 mm[.1 in]

Usage Conditions

Operating Temperature Range	-65 – 105 °C[-85 – 221 °F]
-----------------------------	----------------------------

Operation/Application

Circuit Application	Signal
---------------------	--------

Industry Standards

Approved Standards	CSA LR7189, UL E28476
UL Flammability Rating	UL 94V-0

Packaging Features

Packaging Quantity	1
Packaging Method	Package

Other

Discrete Wire Connector Comment	Cavity identification, AMP, part number and date code stamped on housing where size permits., Strain reliefs are available and may be purchased separately.
---------------------------------	---

Product Compliance

[For compliance documentation, visit the product page on TE.com>](#)

EU RoHS Directive 2011/65/EU	Compliant
EU ELV Directive 2000/53/EC	Compliant
China RoHS 2 Directive MIIT Order No 32, 2016	No Restricted Materials Above Threshold
EU REACH Regulation (EC) No. 1907/2006	Current ECHA Candidate List: JUNE 2023 (235) Candidate List Declared Against: JUNE 2023 (235) Does not contain REACH SVHC
Halogen Content	BFR/CFR/PVC Free, but Br/Cl >900 ppm in other sources.
Solder Process Capability	Not applicable for solder process capability

Product Compliance Disclaimer

This information is provided based on reasonable inquiry of our suppliers and represents our current actual knowledge based on the information they provided. This information is subject to change. The part numbers that TE has identified as EU RoHS compliant have a maximum concentration of 0.1% by weight in homogenous materials for lead, hexavalent chromium, mercury, PBB, PBDE, DBP, BBP, DEHP, DIBP, and 0.01% for cadmium, or qualify for an exemption to these limits as defined in the Annexes of Directive 2011/65/EU (RoHS2). Finished electrical and electronic equipment products will be CE marked as required by Directive 2011/65/EU. Components may not be CE marked. Additionally, the part numbers that TE has identified as EU ELV compliant have a maximum concentration of 0.1% by weight in homogenous materials for lead, hexavalent chromium, and mercury, and 0.01% for cadmium, or qualify for an exemption to these limits as defined in the Annexes of Directive 2000/53/EC (ELV). Regarding the REACH Regulation, the information TE provides on SVHC in articles for this part number is based on the latest European Chemicals Agency (ECHA) 'Guidance on requirements for substances in articles' posted at this URL: <https://echa.europa.eu/guidance-documents/guidance-on-reach>

Compatible Parts

 <p>TE Part # 5-103167-2 10 MODII HDR DRRA SHRD LF</p>	 <p>TE Part # 5-103169-3 10 MODII HDR DRST SHRD .100CL</p>	 <p>TE Part # 5-102618-3 10 MODII HDR DRST SHRD .100CL</p>	 <p>TE Part # 5-103168-3 10 MODII HDR DRST SHRD .100CL</p>
 <p>TE Part # 5-87589-1 10 MODII HDR DRST SHRD .100CL</p>	 <p>TE Part # 87666-2 MOD IV RECP PLTD 30 SEL</p>	 <p>TE Part # 6-87756-7 MOD IV REC STP INT'L SPEC REEL</p>	 <p>TE Part # 87756-6 MOD IV RECP PLTD SN</p>

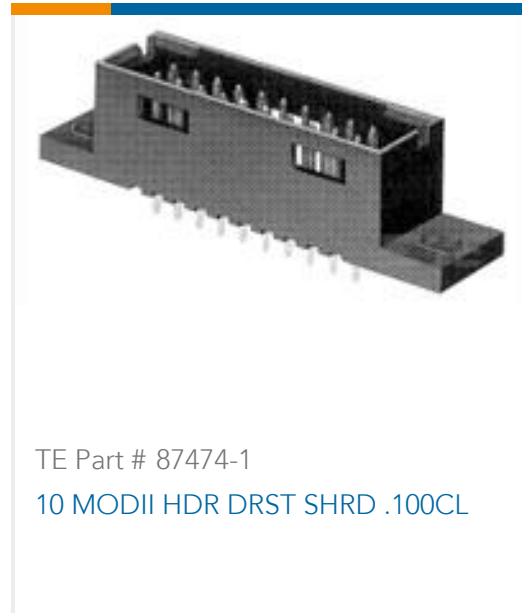
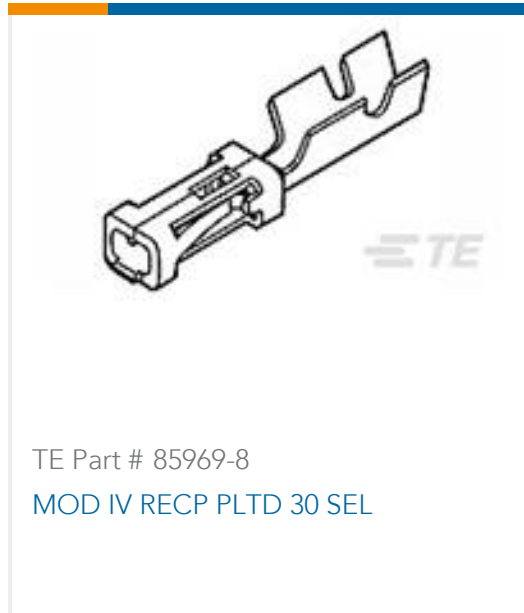
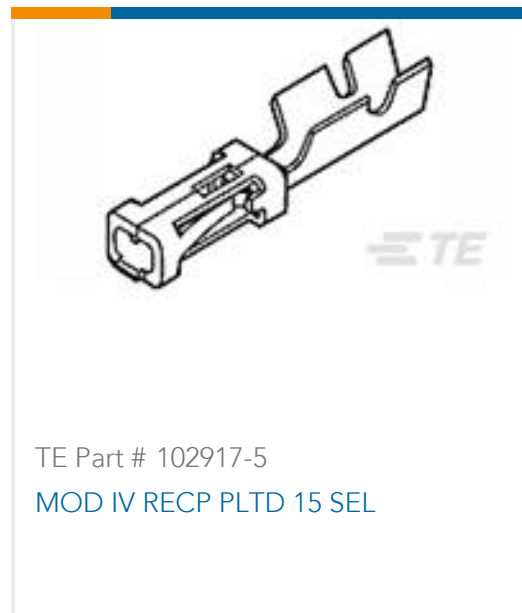

Also in the Series | AMPMODU IV/V

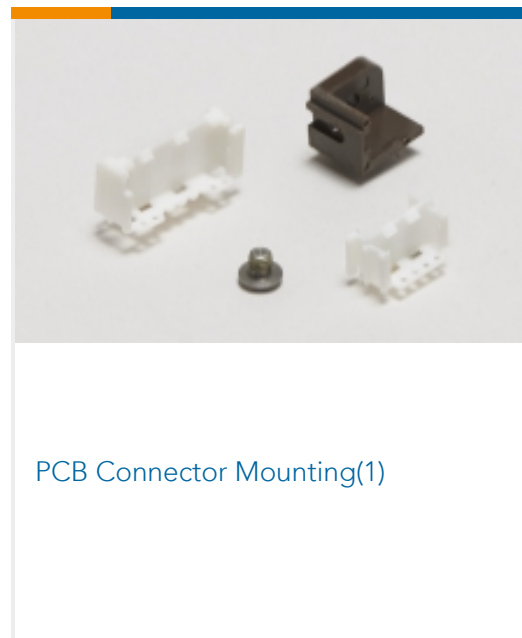
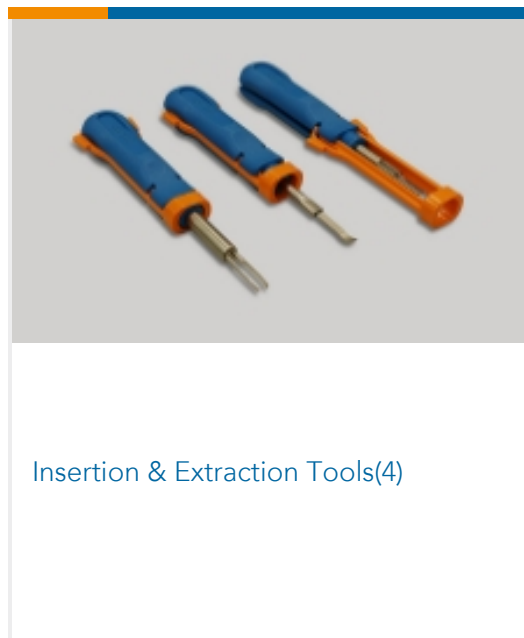
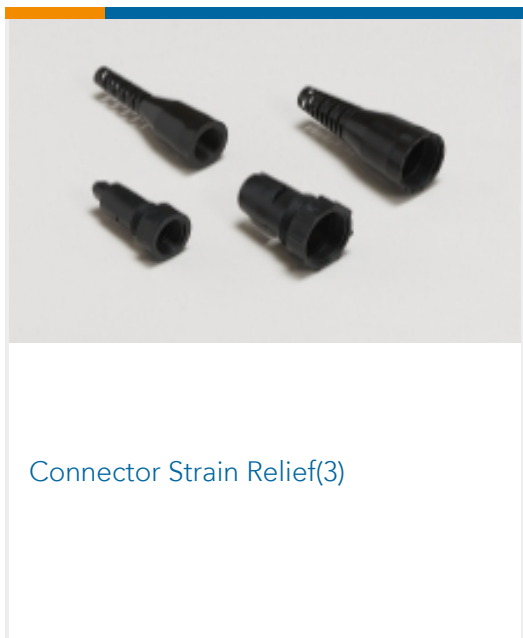
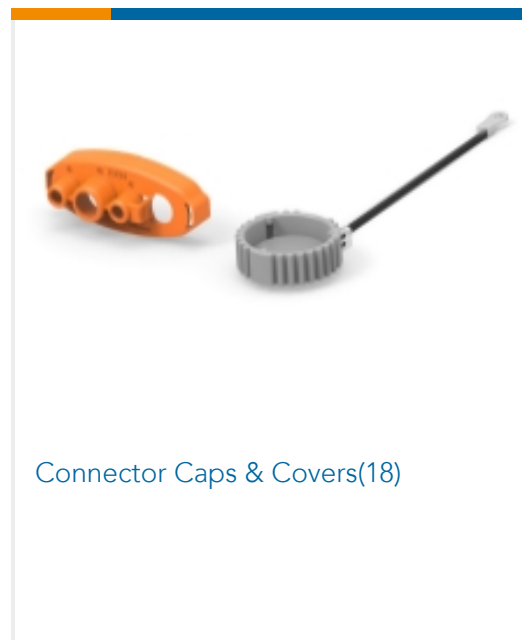
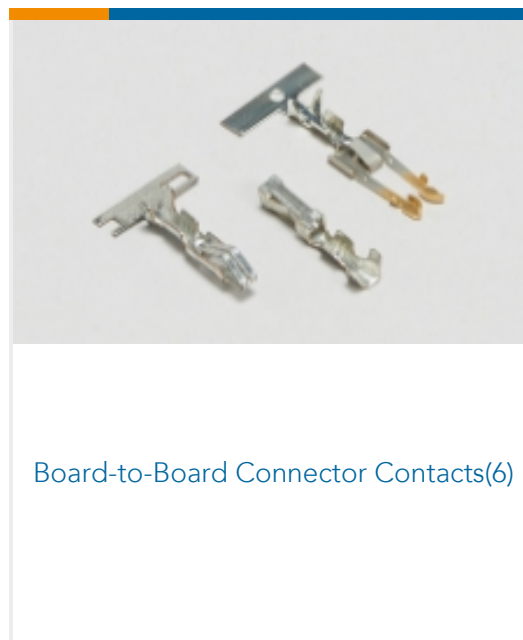
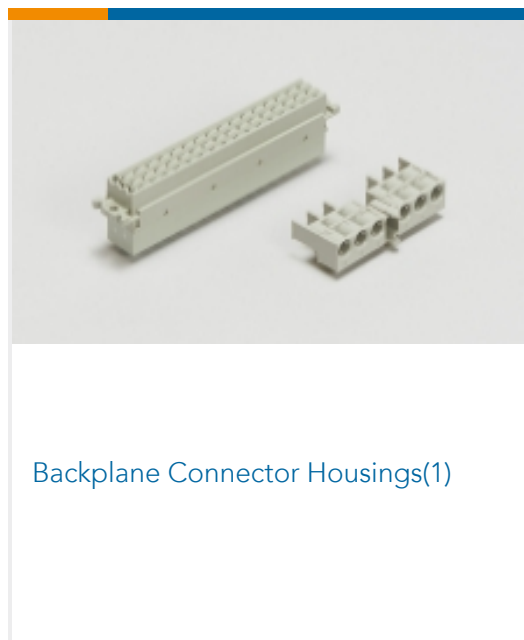
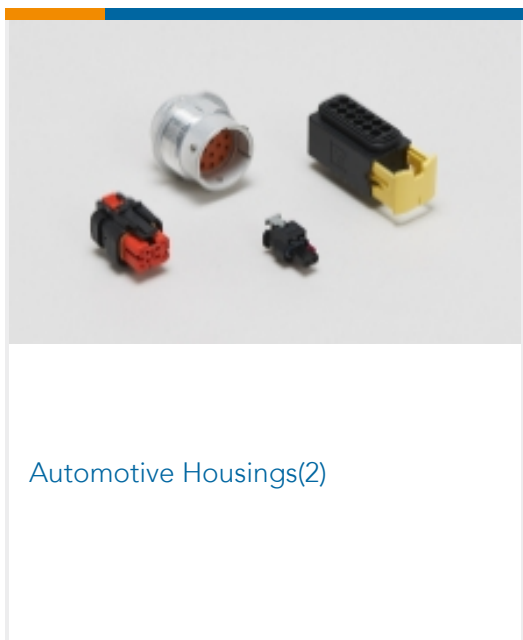



PCB Headers & Receptacles(934)



PCB Latches, Locks & Retainers(7)



Rectangular Connector Housings(5)



Standard Rectangular Connectors(8)



Wire-to-Board Connector Assemblies & Housings(447)



Wire-to-Board Connector Contacts (322)

Customers Also Bought

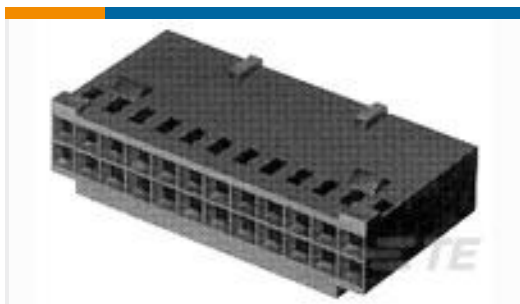

TE Part #87631-3
08 MODIV HSG COMP DR .100 POL

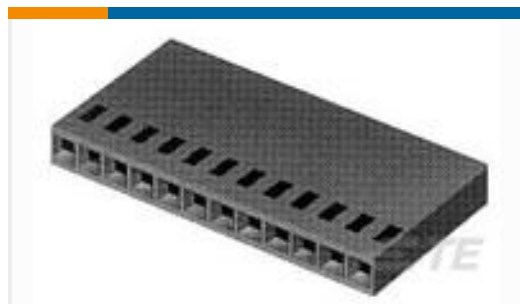

TE Part #87499-3
02 MODIV HSG SR MRKD .100CL

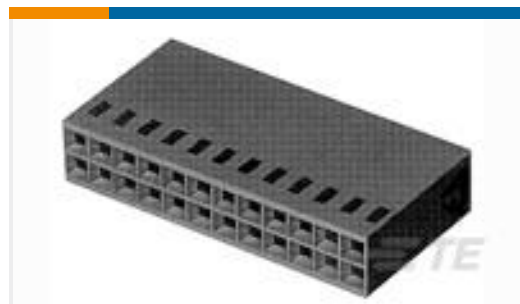

TE Part #87456-3
08 MODIV HSG COMP DR .100CL



TE Part #776537-1
AS 16, 6P CAP ASSY, RD, KEY 1

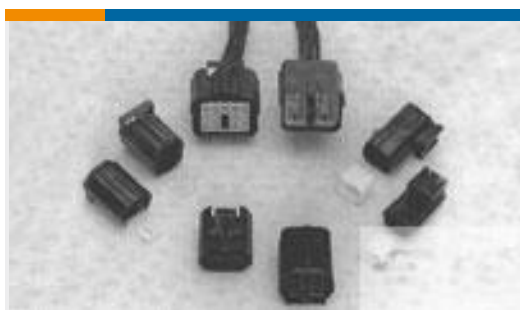

TE Part #344268-1
4 WAY TAB HOUSING ECONO

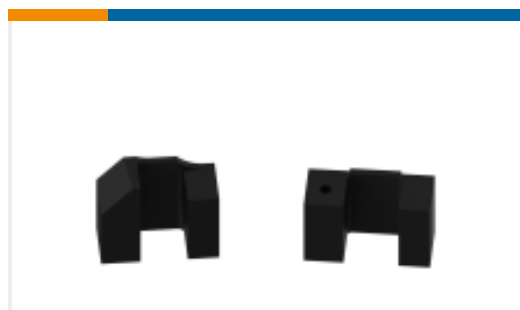

TE Part #2119805-1
SHEAR HOLDER, FRONT, CUT



TE Part #2119806-1
INSERT, SHEAR

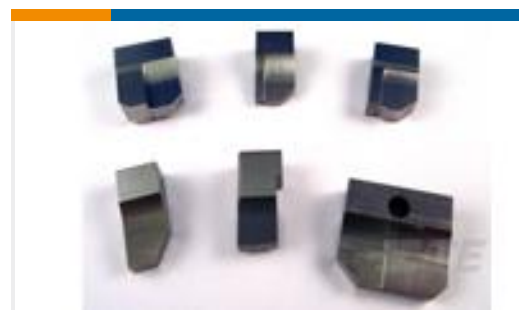

TE Part #5-1333205-6
ANVIL, COMBINATION .090

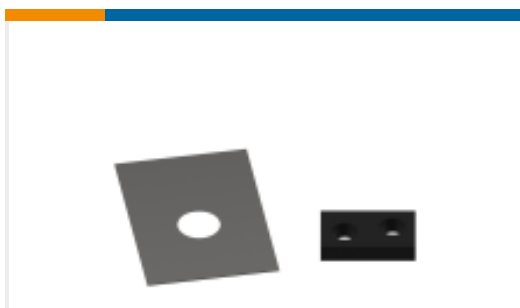

TE Part #238011-4
SPACER, BLOCK CRIMPER (.104)



TE Part #2119791-9
DEPRESSOR, WIRE

Documents



CAD Files

3D PDF

English

Customer View Model

[ENG_CVM_87977-3_S.2d_dxf.zip](#)

English

Customer View Model

[ENG_CVM_87977-3_S.3d_igs.zip](#)

English

Customer View Model

[ENG_CVM_87977-3_S.3d_stp.zip](#)

English

3D PDF

3D

Customer View Model

[ENG_CVM_CVM_87977-3_AB.2d_dxf.zip](#)

English

Customer View Model

[ENG_CVM_CVM_87977-3_AB.3d_igs.zip](#)

English

Customer View Model

[ENG_CVM_CVM_87977-3_AB.3d_stp.zip](#)

English

By downloading the CAD file I accept and agree to the [Terms and Conditions](#) of use.

Datasheets & Catalog Pages

[AMPMODU_INTERCONNECTION_SYSTEM_SECTION5_CONT](#)

English

Product Specifications

[Application Specification](#)

English

Product Environmental Compliance

[Product Compliance Document](#)

English

[Product Compliance Document](#)

English

Agency Approvals

[UL](#)

English