

87667-2 ✓ ACTIVE

AMPMODU | AMPMODU IV/V

TE Internal #: 87667-2

Connector Contact, Socket, Wire-to-Board, 26 – 22 AWG Wire Size,  
236.823 – 789.41 CMA Wire Size, .12 – .4 mm<sup>2</sup> Wire Size, Gold,  
AMPMODU IV/V

[View on TE.com >](#)



Connectors > PCB Connectors > Wire-to-Board Connectors > Wire-to-Board Connector Contacts

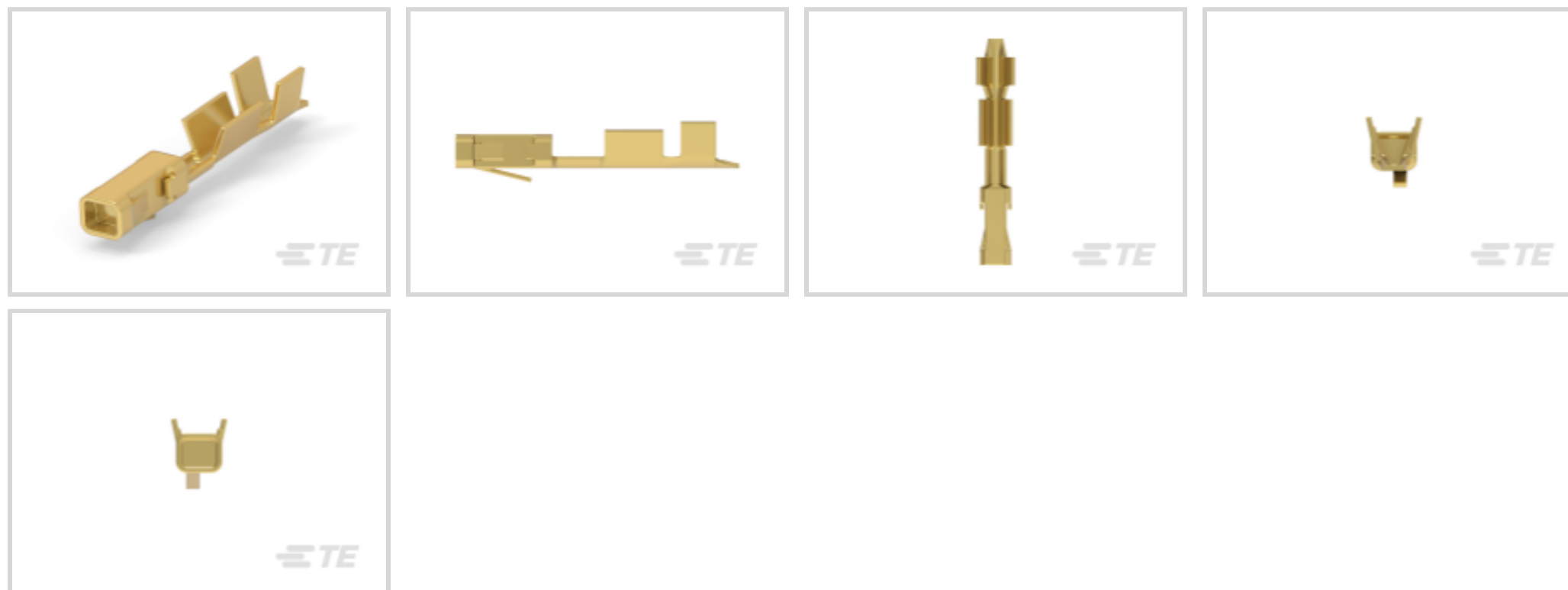

Contact Type: **Socket**

Connector System: **Wire-to-Board**

Wire Size: **.12 – .4 mm<sup>2</sup>**

## Features

### Product Type Features

Applied Pressure	Standard
Connector System	Wire-to-Board
Connector & Contact Terminates To	Wire & Cable

### Configuration Features

Compatible With Wire & Cable Type	Discrete Wire
-----------------------------------	---------------

### Electrical Characteristics

Termination Resistance	12 mΩ
Insulation Resistance	5000 MΩ
Dielectric Withstanding Voltage (Max)	750 V
Operating Voltage	250 VAC

### Contact Features

Mating Square Post Dimension	.64 mm [.025 in]
Wire Contact Termination Area Plating Material	Gold Flash
	30 μin
Contact Base Material	Beryllium Copper



Contact Type	Socket
Contact Mating Area Plating Material	Gold
Contact Current Rating (Max)	3 A

#### Termination Features

Termination Method to Wire & Cable	Crimp
------------------------------------	-------

#### Mechanical Attachment

Wire Insulation Support	With
-------------------------	------

#### Dimensions

Compatible Insulation Diameter Range	1.55 mm[.061 in]
Wire Size	.12 – .4 mm <sup>2</sup>

#### Usage Conditions

Operating Temperature Range	-65 – 105 °C[-85 – 221 °F]
-----------------------------	----------------------------

#### Operation/Application

Circuit Application	Power & Signal
---------------------	----------------

#### Industry Standards

Approved Standards	CSA LR7189, UL E28476
--------------------	-----------------------

#### Packaging Features

Packaging Quantity	1000
Packaging Method	Loose Piece

#### Other

Connector Contacts Comment	(*) For use with Model "K" machines. Call the Technical Assistance Center (1-800-522-6752) for any tooling questions.
----------------------------	---

### Product Compliance

For compliance documentation, visit the product page on [TE.com](https://www.te.com)>

EU RoHS Directive 2011/65/EU	Compliant
EU ELV Directive 2000/53/EC	Compliant
China RoHS 2 Directive MIIT Order No 32, 2016	No Restricted Materials Above Threshold
EU REACH Regulation (EC) No. 1907/2006	Current ECHA Candidate List: JUNE 2023 (235) Candidate List Declared Against: JUNE 2023 (235) Does not contain REACH SVHC

Halogen Content	Low Halogen - Br, Cl, F, I < 900 ppm per homogenous material. Also BFR/CFR/PVC Free
Solder Process Capability	Not applicable for solder process capability







Product Compliance Disclaimer

This information is provided based on reasonable inquiry of our suppliers and represents our current actual knowledge based on the information they provided. This information is subject to change. The part numbers that TE has identified as EU RoHS compliant have a maximum concentration of 0.1% by weight in homogenous materials for lead, hexavalent chromium, mercury, PBB, PBDE, DBP, BBP, DEHP, DIBP, and 0.01% for cadmium, or qualify for an exemption to these limits as defined in the Annexes of Directive 2011/65/EU (RoHS2). Finished electrical and electronic equipment products will be CE marked as required by Directive 2011/65/EU. Components may not be CE marked. Additionally, the part numbers that TE has identified as EU ELV compliant have a maximum concentration of 0.1% by weight in homogenous materials for lead, hexavalent chromium, and mercury, and 0.01% for cadmium, or qualify for an exemption to these limits as defined in the Annexes of Directive 2000/53/EC (ELV). Regarding the REACH Regulation, the information TE provides on SVHC in articles for this part number is based on the latest European Chemicals Agency (ECHA) 'Guidance on requirements for substances in articles' posted at this URL: <https://echa.europa.eu/guidance-documents/guidance-on-reach>

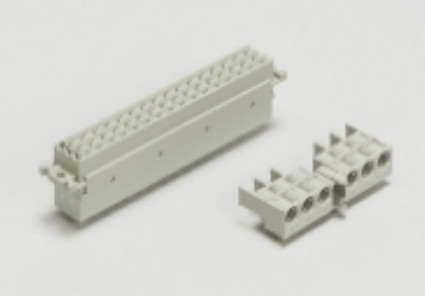
### Compatible Parts

			
TE Part # 91517-1 CCII FEMALE MOD IV REC 24-22 ASSY	TE Part # 58641-1 PRO-CRIMP TL & DIE MOD IV	TE Part # 843996-3 TOOL, EXTRACTION RESET	TE Part # 58641-2 PROCRIMP DIE MOD IV

### Also in the Series | AMPMODU IV/V

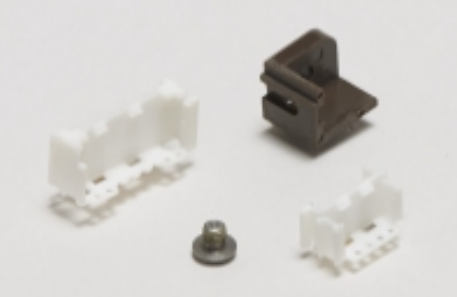
			
Automotive Housings(2)	Backplane Connector Housings(1)	Board-to-Board Connector Contacts(6)	Connector Caps & Covers(18)
			
Connector Strain Relief(3)	Insertion & Extraction Tools(4)	PCB Connector Keying(6)	PCB Connector Mounting(1)

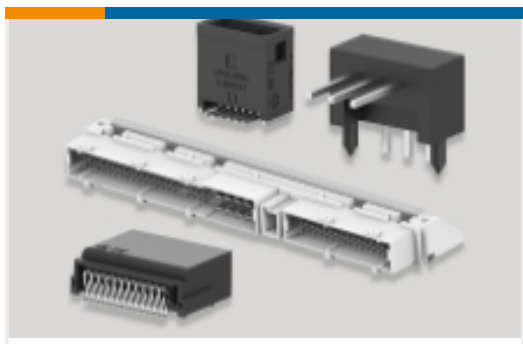

PCB Headers & Receptacles(934)

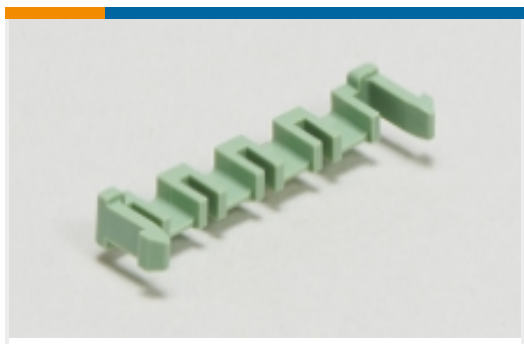

PCB Latches, Locks & Retainers(7)



Rectangular Connector Housings(5)

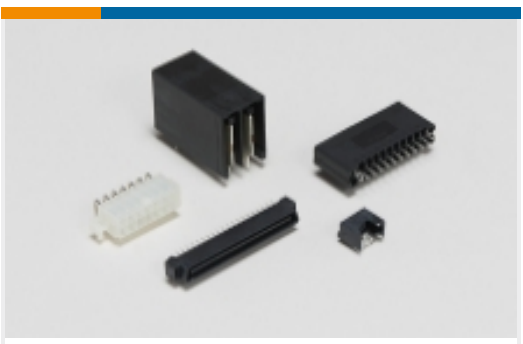

Standard Rectangular Connectors(8)



Wire-to-Board Connector Assemblies & Housings(447)



Wire-to-Board Connector Contacts (322)

## Customers Also Bought



TE Part #206127-1  
CPC SPECIAL ASSEMBLY SIZE 17



TE Part #206458-1  
CPC RECPT ASSEMBLY SIZE 11-8

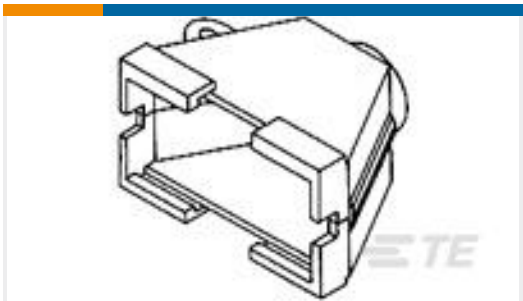

TE Part #350523-1  
15P STR/REL HSG HNGD V0



TE Part #6-104935-1  
11 MTE HDR SRRA LTCH.100CL LF



TE Part #2908663002  
RAY-90-15.0(50)



TE Part #206518-2  
CPC RECPT ASSEMBLY SIZE 11-4



TE Part #YDTS20F21-35PAV001  
RECP ASSY



TE Part #YDTS20F25-35PAV001  
RECP ASSY

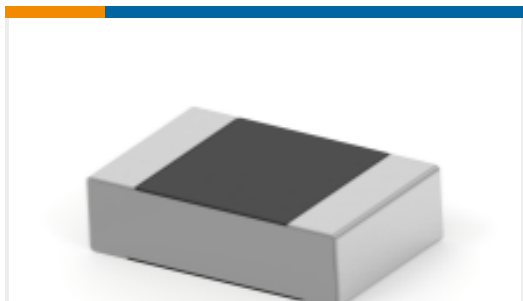

TE Part #3-1614959-6  
CPF0805 1M78 0.1% 25PPM 1K RL

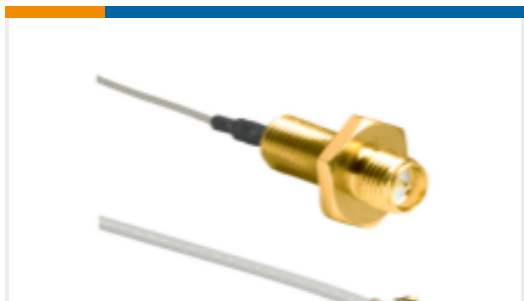

TE Part #CSI-RGFE-300-UFFR  
RP-SMA to U.FL/MHF1 300mm 1.13  
OD

## Documents





**Product Drawings**

[MOD IV RECP LP](#)

English

---

**CAD Files**

[3D PDF](#)

3D

Customer View Model

[ENG\\_CVM\\_CVM\\_87667-2\\_D.2d\\_dxf.zip](#)

English

Customer View Model

[ENG\\_CVM\\_CVM\\_87667-2\\_D.3d\\_igs.zip](#)

English

Customer View Model

[ENG\\_CVM\\_CVM\\_87667-2\\_D.3d\\_stp.zip](#)

English

By downloading the CAD file I accept and agree to the [Terms and Conditions](#) of use.

---

**Datasheets & Catalog Pages**

[AMPMODU\\_INTERCONNECTION\\_SYSTEM\\_SECTION5\\_CONT](#)

English

---

**Product Specifications**

[Application Specification](#)

English

---

**Product Environmental Compliance**

[MD\\_87667-2\\_031620181331\\_dmtec](#)

English

[MD\\_87667-2\\_031620181331\\_dmtec](#)

English

---