

8-33461-1 ✓ ACTIVE

SOLISTRAND

TE Internal #: 8-33461-1

Closed Ring Tongue Terminal, 8 AWG, M6 / 1/4 Stud Size, 6.73 mm [.265 in] Stud Diameter, Closed Barrel, Straight, Tin, Uninsulated

[View on TE.com >](#)



Terminals & Splices > Ring Terminals

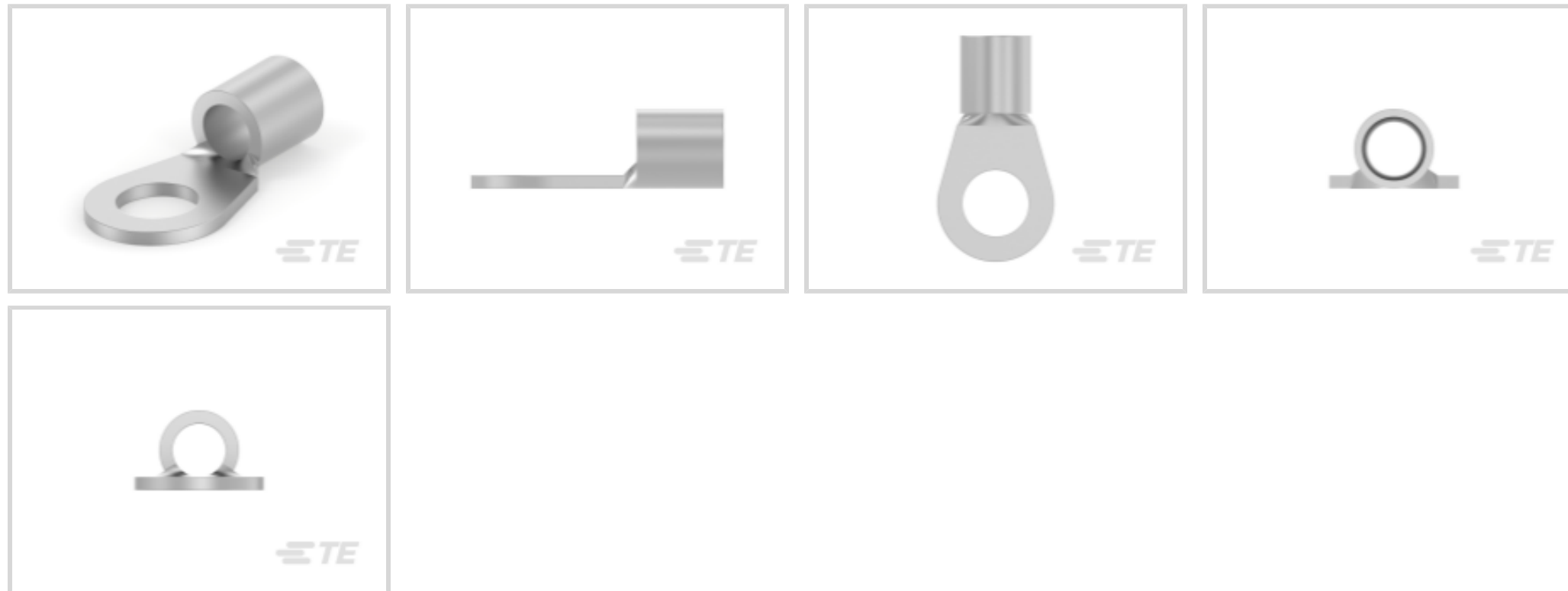

Ring Terminal Product Type: Closed Ring Tongue Terminal

Wire Size: 13100 – 20800 CMA

Stud Size: 1/4, M6

Features

Product Type Features

Ring Terminal Product Type	Closed Ring Tongue Terminal
Stud Size	1/4, M6
Sealable	No
Wire Insulation Support Retention Type	Non-Insulation Support

Configuration Features

Number of Holes	1
-----------------	---

Body Features

Product Weight	2.834 g
----------------	---------

Contact Features

Barrel Type	Closed
Terminal Orientation	Straight
Terminal Plating Material	Tin

Mechanical Attachment

Wire Insulation Support	Without
-------------------------	---------

Dimensions

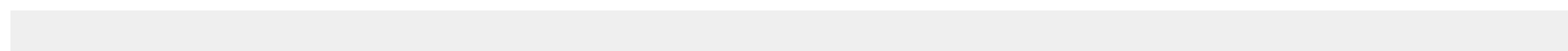



Wire Size	13100 – 20800 CMA
Stud Diameter	6.73 mm [.265 in]
Tongue Thickness	1.22 mm [.048 in]
Product Length	23.7 mm [.933 in]
Barrel Inside Diameter	4.37 mm [.172 in]

Usage Conditions

Insulation Option	Uninsulated
Operating Temperature Range	170 °C [338 °F]

Operation/Application

Compatible With Wire Base Material	Copper
Compatible With Wire Plating Material	Tin

Industry Standards

Government Qualified Terminal	No
-------------------------------	----

Packaging Features

Packaging Quantity	100
Packaging Method	Loose Piece

Other

Terminals & Splices Comment	Requires a 69875 standard TAPETRONIC machine for application.
-----------------------------	---

Product Compliance









[For compliance documentation, visit the product page on TE.com>](#)

EU RoHS Directive 2011/65/EU	Compliant
EU ELV Directive 2000/53/EC	Compliant
China RoHS 2 Directive MIIT Order No 32, 2016	No Restricted Materials Above Threshold
EU REACH Regulation (EC) No. 1907/2006	Current ECHA Candidate List: JUNE 2023 (235) Candidate List Declared Against: JUNE 2023 (235) Does not contain REACH SVHC
Halogen Content	Low Halogen - Br, Cl, F, I < 900 ppm per homogenous material. Also BFR/CFR/PVC Free
Solder Process Capability	Not applicable for solder process capability

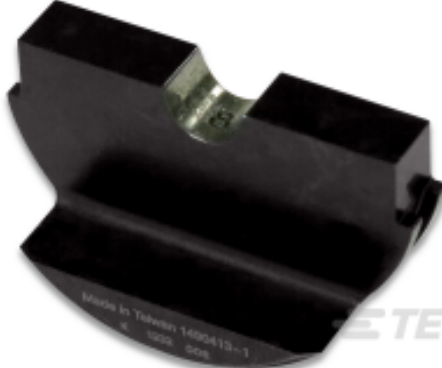
Product Compliance Disclaimer

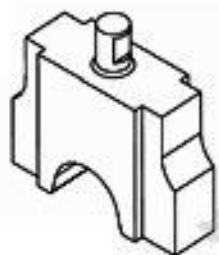
This information is provided based on reasonable inquiry of our suppliers and represents our current actual knowledge based on the information they provided. This information is subject to change. The part numbers that TE has identified as EU RoHS compliant have a maximum concentration of 0.1% by weight in homogenous materials for lead, hexavalent chromium, mercury, PBB, PBDE, DBP, BBP, DEHP, DIBP, and 0.01% for cadmium, or qualify for an exemption to these limits as defined in the Annexes of Directive 2011/65/EU (RoHS2). Finished electrical and electronic equipment products will be CE marked as required by Directive 2011/65/EU. Components may not be CE marked. Additionally, the part numbers that TE has identified as EU ELV compliant have a maximum concentration of 0.1% by weight in homogenous materials for lead, hexavalent chromium, and mercury, and 0.01% for cadmium, or qualify for an exemption to these limits as defined in the Annexes of Directive 2000/53/EC (ELV). Regarding the REACH Regulation, the information TE provides on SVHC in articles for this part number is based on the latest European Chemicals Agency (ECHA) 'Guidance on requirements for substances in articles' posted at this URL: <https://echa.europa.eu/guidance-documents/guidance-on-reach>

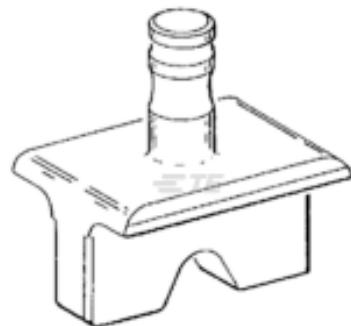
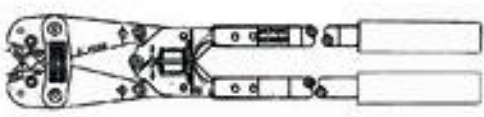
Compatible Parts

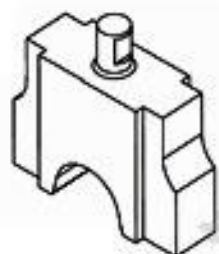
 <p>TE Part # 601075 BANTAM ROTA-CRIMP TOOL</p>	 <p>TE Part # 69355 HHHT SOLIS SOLIS FLAG STRATO 8 ASSY</p>	 <p>TE Part # 1490413-1 HYP10 SOLIS 8AWG NEST</p>	 <p>TE Part # 1490414-1 HYP10 SOLIS 8AWG INDENTER</p>
 <p>TE Part # 1901001-1 NEST #8</p>	 <p>TE Part # 48355 HYP8 SOLIS 8AWG INDENTER</p>	 <p>TE Part # 69216 HYP8/10 SOLIS 8AWG DIE SET</p>	 <p>TE Part # 48126 HYP8 SOLIS 8AWG NEST</p>
 <p>TE Part # 600850 ROTO-CRIMP TOOL (ASI)</p>	 <p>TE Part # 69339 HHHT SOLIS SOLIS FLAG STRATO 8 ASSY</p>	 <p>TE Part # 1901002-2 INDENTER, SOLISTRAND</p>	

Customers Also Bought

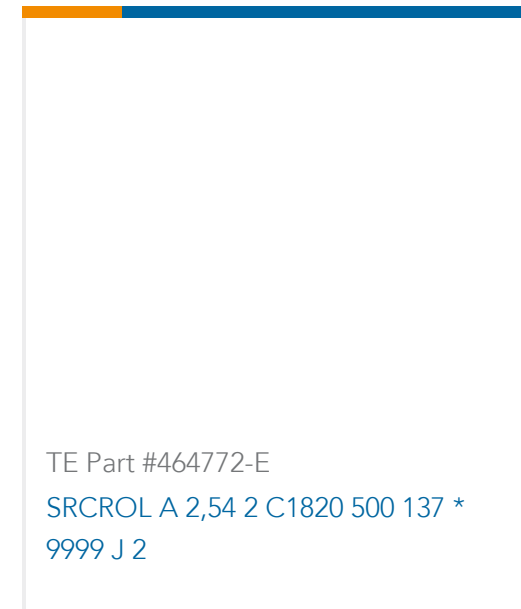
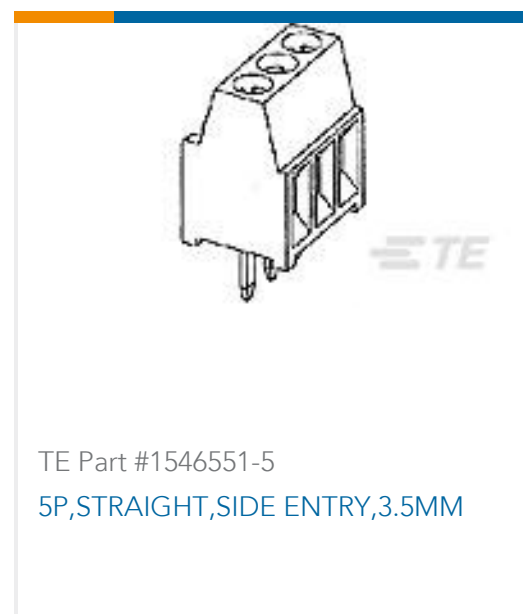

Documents

Product Drawings

[TERMINAL,SOLIS R 8 1/4](#)

English

CAD Files

Customer View Model

[ENG_CVM_CVM_8-33461-1_T.2d_dxf.zip](#)

English

3D PDF

3D

Customer View Model

[ENG_CVM_CVM_8-33461-1_T.3d_igs.zip](#)

English

Customer View Model

[ENG_CVM_CVM_8-33461-1_T.3d_stp.zip](#)

English

By downloading the CAD file I accept and agree to the [Terms and Conditions](#) of use.

Datasheets & Catalog Pages

[SOLISTRAND - QRG](#)

English

[RADIATION_RESISTANT_PRE-INSULATED_TERMINALS_SPLICES](#)

English