

8-326875-1 ✓ ACTIVE



PIDG

TE Internal #: 8-326875-1

Closed Ring Tongue Terminal, 26 – 22 AWG, #6 / M3.5 Stud Size, 3.68 mm [.145 in] Stud Diameter, Closed Barrel, Straight, Tin, PIDG

[View on TE.com >](#)

Terminals & Splices > Ring Terminals > PIDG Ring Tongue Terminals

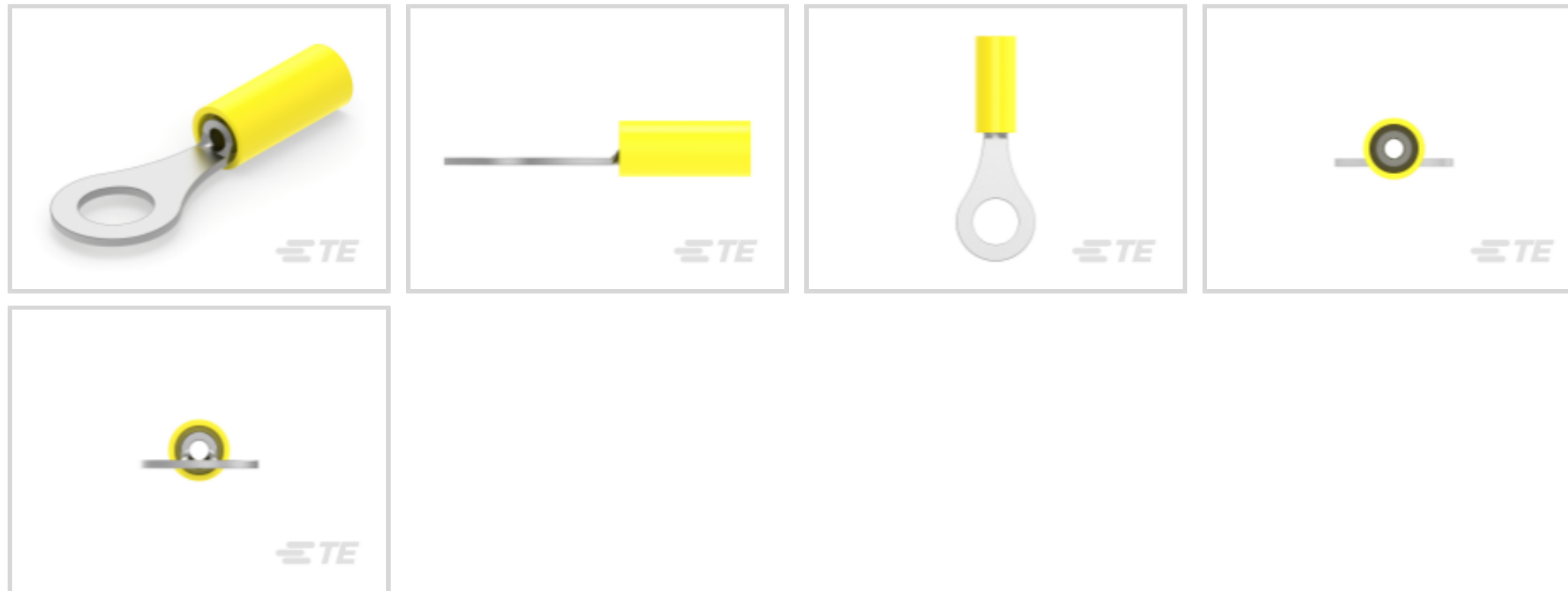

Ring Terminal Product Type: Closed Ring Tongue Terminal

Wire Size: 202 – 810 CMA

Stud Size: #6, M3.5

[All PIDG Ring Tongue Terminals \(418\)](#)

## Features

### Product Type Features

Terminal Features	Inspection Slot
Ring Terminal Product Type	Closed Ring Tongue Terminal
Stud Size	#6, M3.5
Sealable	No
Wire Insulation Support Retention Type	Insulation Support

### Configuration Features

Number of Holes	1
-----------------	---

### Electrical Characteristics

Voltage Rating	300 V
----------------	-------

### Body Features

Product Weight	.317 g
----------------	--------

### Contact Features

Military Part Class	Class II
Barrel Type	Closed



Terminal Orientation	Straight
----------------------	----------

Terminal Plating Material	Tin
---------------------------	-----

### Mechanical Attachment

Wire Insulation Support	With
-------------------------	------

### Dimensions

Wire Size	202 – 810 CMA
-----------	---------------

Stud Diameter	3.68 mm [.145 in]
---------------	-------------------

Tongue Thickness	.5 mm [.02 in]
------------------	----------------

Product Length	18.8 mm [.74 in]
----------------	------------------

Compatible Insulation Diameter (Max)	2.08 mm [.082 in]
--------------------------------------	-------------------

Compatible Insulation Diameter Range	1.27 – 2.08 mm [.05 – .082 in]
--------------------------------------	--------------------------------

### Usage Conditions

Insulation Option	Partially Insulated
-------------------	---------------------

Operating Temperature Range	105 °C [221 °F]
-----------------------------	-----------------

### Operation/Application

Compatible With Wire Base Material	Copper
------------------------------------	--------

Compatible With Wire Plating Material	Tin
---------------------------------------	-----

### Industry Standards

Government Qualified Terminal	No
-------------------------------	----

### Packaging Features

Packaging Quantity	100
--------------------	-----

Packaging Method	Loose Piece
------------------	-------------

### Product Compliance

[For compliance documentation, visit the product page on TE.com>](#)

EU RoHS Directive 2011/65/EU	Compliant
------------------------------	-----------

EU ELV Directive 2000/53/EC	Compliant
-----------------------------	-----------

China RoHS 2 Directive MIIT Order No 32, 2016	No Restricted Materials Above Threshold
---	---

EU REACH Regulation (EC) No. 1907/2006	Current ECHA Candidate List: JUNE 2023 (235) Candidate List Declared Against: JUNE 2023 (235) Does not contain REACH SVHC
--	---

Halogen Content	Low Halogen - Br, Cl, F, I < 900 ppm per homogenous material. Also BFR/CFR/PVC Free
Solder Process Capability	Not applicable for solder process capability

Product Compliance Disclaimer

This information is provided based on reasonable inquiry of our suppliers and represents our current actual knowledge based on the information they provided. This information is subject to change. The part numbers that TE has identified as EU RoHS compliant have a maximum concentration of 0.1% by weight in homogenous materials for lead, hexavalent chromium, mercury, PBB, PBDE, DBP, BBP, DEHP, DIBP, and 0.01% for cadmium, or qualify for an exemption to these limits as defined in the Annexes of Directive 2011/65/EU (RoHS2). Finished electrical and electronic equipment products will be CE marked as required by Directive 2011/65/EU. Components may not be CE marked. Additionally, the part numbers that TE has identified as EU ELV compliant have a maximum concentration of 0.1% by weight in homogenous materials for lead, hexavalent chromium, and mercury, and 0.01% for cadmium, or qualify for an exemption to these limits as defined in the Annexes of Directive 2000/53/EC (ELV). Regarding the REACH Regulation, the information TE provides on SVHC in articles for this part number is based on the latest European Chemicals Agency (ECHA) 'Guidance on requirements for substances in articles' posted at this URL: <https://echa.europa.eu/guidance-documents/guidance-on-reach>

## Compatible Parts



REPRESENTATION ONLY TE

TE Part # 46121  
DAHT PG PIDG 26-22 ASSY



TE Part # 59275  
T-HEAD PIDG PG SH 26-20 ASSY



TE Part # 69344  
PIDG 26-22 DIE SET

## Also in the Series | PIDG



Compression Connectors(17)



Crimp Terminal Housings(1)



Crimp Wire Pins, Tabs & Ferrules(41)



Hand Crimping Tools(2)

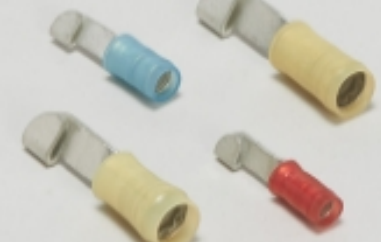

Knife Disconnects(11)



PCB Terminals(7)



Quick Disconnects(49)



Ring Terminals(611)

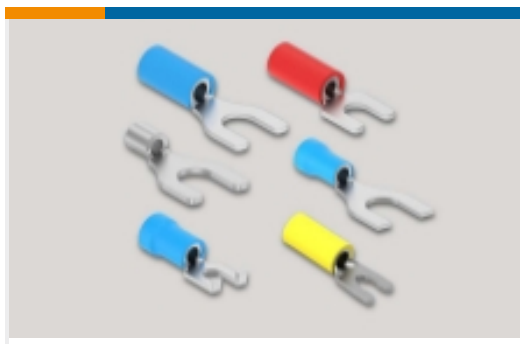

Spade Terminals(233)



Special Purpose Terminals(1)



Splices(46)

## Customers Also Bought



TE Part #7-51863-1  
PIDG R 22-16 COMM 22-18 MIL 6



TE Part #66102-4  
III+ PIN,24-20,30AU/FL,STRIP

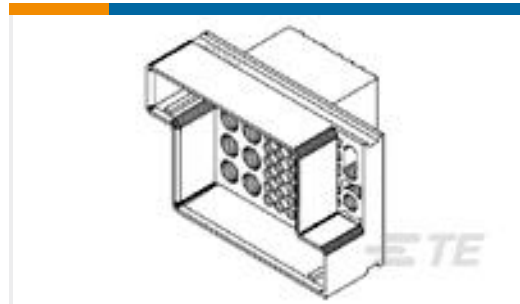

TE Part #194243-1  
AMPOWER HOUSING,RCPT,43 POS

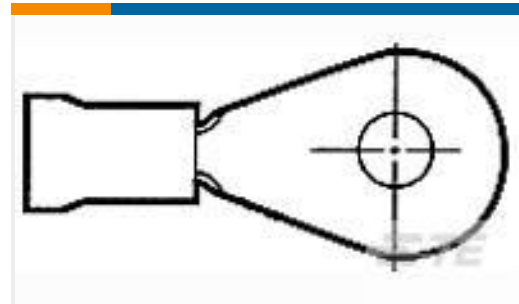

TE Part #55621-2  
TERMINAL R PG 8 1/4



TE Part #451555J001  
V4-2.0-0-SP-SM



TE Part #EM7488-000  
X2-7.0-0-SP-SM



TE Part #1-66740-1  
TYPE XII FEMALE CONT (STRIP)



TE Part #194189-8  
PIN ASSY., CRIMP

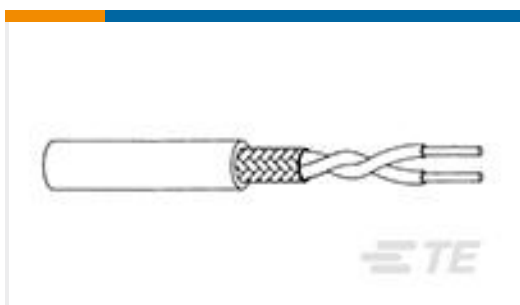

TE Part #180321-000  
2022E0421-9X



TE Part #794065-2  
08P MINI UMNL HDR W/DH AU

## Documents

### Product Drawings

[TERMINAL,PIDG R 26-22 6](#)

English

### CAD Files

[3D PDF](#)

[3D](#)

### Customer View Model

[ENG\\_CVM\\_CVM\\_8-326875-1\\_W.2d\\_dxf.zip](#)



English

Customer View Model

[ENG\\_CVM\\_CVM\\_8-326875-1\\_W.3d\\_igs.zip](#)

English

Customer View Model

[ENG\\_CVM\\_CVM\\_8-326875-1\\_W.3d\\_stp.zip](#)

English

By downloading the CAD file I accept and agree to the [Terms and Conditions](#) of use.

---

## Product Specifications

[Application Specification](#)

English

---

## Product Environmental Compliance

[TE Material Declaration](#)

English