

8-324165-1 ✓ ACTIVE

PLASTI-GRIP

TE Internal #: 8-324165-1

Spade Tongue Terminal, 16 – 14 AWG, #6 / M3.5 Stud Size, 3.68 mm [.145 in] Stud Diameter, Closed Barrel, Flanged, Tin, PLASTI-GRIP

[View on TE.com >](#)



Terminals & Splices > Spade Terminals

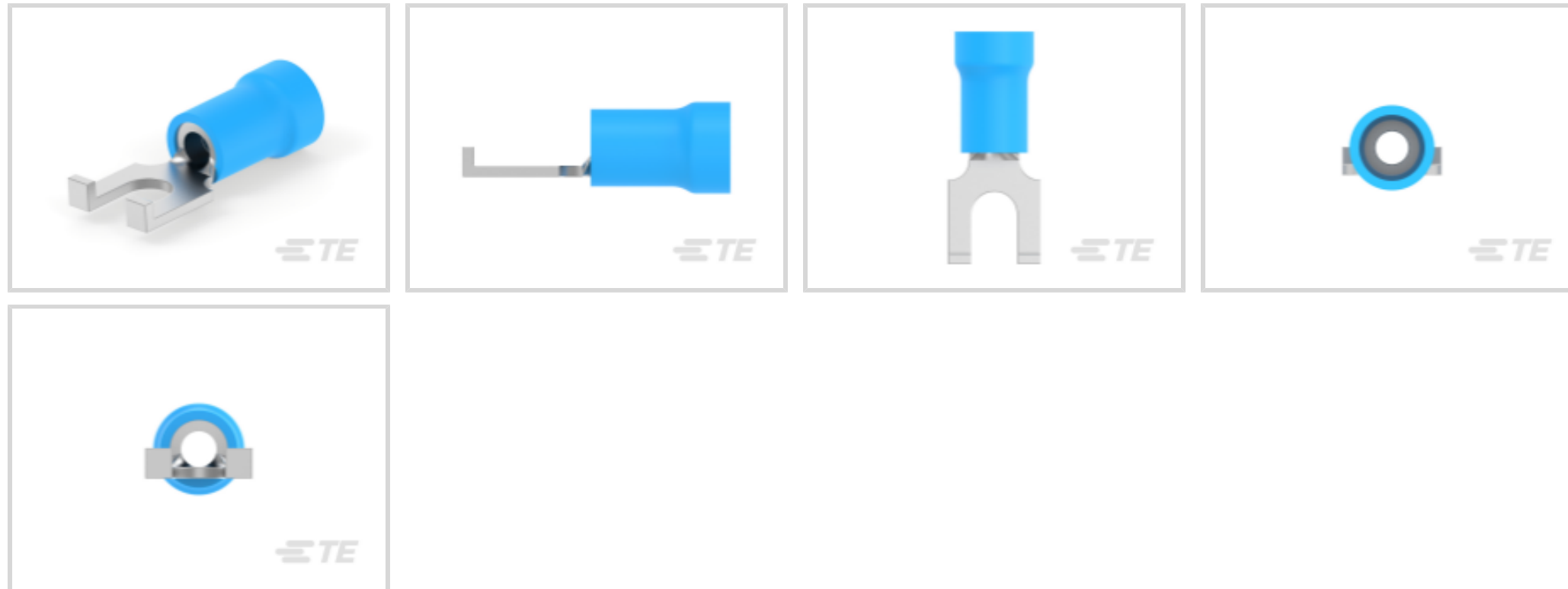

Spade Terminal Type: **Spade Tongue Terminal**

Wire Size: **2050 – 5180 CMA**

Stud Size: **#6, M3.5**

Features

Product Type Features

Stud Size	#6, M3.5
Sealable	No
Wire Insulation Support Retention Type	Insulation Support

Electrical Characteristics

Voltage Rating	600 V
----------------	-------

Body Features

Product Weight	.595 g
Insulation Sleeve Color	Blue
Stripe Color	Blue

Contact Features

Spade Terminal Type	Spade Tongue Terminal
Barrel Type	Closed
Terminal Orientation	Flanged
Terminal Plating Material	Tin

Mechanical Attachment



Wire Insulation Support	With
-------------------------	------

Dimensions

Wire Size	2050 – 5180 CMA
Stud Diameter	3.68 mm [.145 in]
Tongue Thickness	.79 mm [.031 in]
Product Length	19.02 mm [.749 in]
Compatible Insulation Diameter (Max)	4.9 mm [.193 in]
Compatible Insulation Diameter Range	3 – 4.9 mm [.118 – .193 in]

Usage Conditions

Insulation Option	Partially Insulated
Operating Temperature Range	105 °C [221 °F]

Operation/Application

Compatible With Wire Base Material	Copper
Compatible With Wire Plating Material	Tin

Industry Standards

Government Qualified Terminal	No
-------------------------------	----

Packaging Features

Packaging Quantity	100
Packaging Method	Loose Piece

Product Compliance











[For compliance documentation, visit the product page on TE.com>](#)

EU RoHS Directive 2011/65/EU	Compliant
EU ELV Directive 2000/53/EC	Compliant
China RoHS 2 Directive MIIT Order No 32, 2016	No Restricted Materials Above Threshold
EU REACH Regulation (EC) No. 1907/2006	Current ECHA Candidate List: JUNE 2023 (235) Candidate List Declared Against: JUNE 2023 (235) Does not contain REACH SVHC
Halogen Content	Not Low Halogen - contains Br or Cl > 900 ppm.
Solder Process Capability	Not applicable for solder process capability

Product Compliance Disclaimer

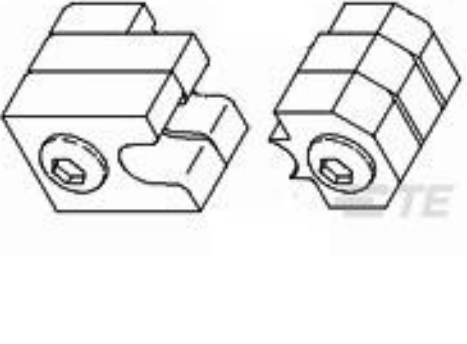
This information is provided based on reasonable inquiry of our suppliers and represents our current actual knowledge based on the information they provided. This information is subject to change. The part numbers that TE has identified as EU RoHS compliant have a maximum concentration of 0.1% by weight in homogenous materials for lead, hexavalent chromium, mercury, PBB, PBDE, DBP, BBP, DEHP, DIBP, and 0.01% for cadmium, or qualify for an exemption to these limits as defined in the Annexes of Directive 2011/65/EU (RoHS2). Finished electrical and electronic equipment products will be CE marked as required by Directive 2011/65/EU. Components may not be CE marked. Additionally, the part numbers that TE has identified as EU ELV compliant have a maximum concentration of 0.1% by weight in homogenous materials for lead, hexavalent chromium, and mercury, and 0.01% for cadmium, or qualify for an exemption to these limits as defined in the Annexes of Directive 2000/53/EC (ELV). Regarding the REACH Regulation, the information TE provides on SVHC in articles for this part number is based on the latest European Chemicals Agency (ECHA) 'Guidance on requirements for substances in articles' posted at this URL: <https://echa.europa.eu/guidance-documents/guidance-on-reach>

Compatible Parts

 <p>TE Part # 59824-1 TETRA-CRIMP PIDG PG FASTON 22-10 ASSY</p>	 <p>TE Part # 59250 T-HEAD PIDG 26-14 ASSY</p>	 <p>TE Part # 47387 DAHT PG PIDG 20-14 ASSY</p>	 <p>TE Part # 58423-1 DIE, RBY IS9252</p>
 <p>TE Part # 58433-3 PRO CR ASSY, RBY IS9252</p>	 <p>TE Part # 539691-2 ERGO DIE R.B.Y</p>	 <p>TE Part # 2063030-1 SDE DIESET, RBY, UL</p>	 <p>TE Part # 47807-1 DIES PIDG 16-14 DIE SET</p>
 <p>TE Part # 169400 CERTI-LOK FRAME W/O DIES</p>	 <p>TE Part # 1SET191001R0000 CRIMP-HT</p>	 <p>TE Part # 1SET191002R0000 TET CRIMP-HT</p>	 <p>TE Part # 169404 CERTI-LOK DIE</p>

Also in the Series | **PLASTI-GRIP**



Compression Connectors(3)



Crimp Wire Pins, Tabs & Ferrules(25)



Ring Terminals(333)

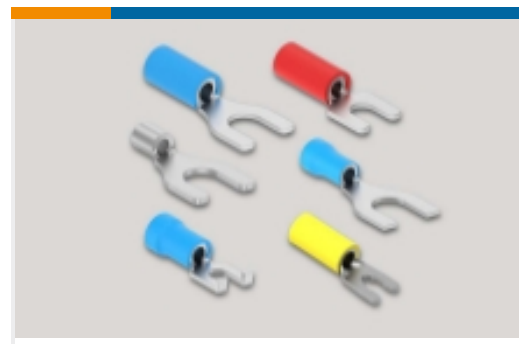

Spade Terminals(198)



Splices(50)

Customers Also Bought

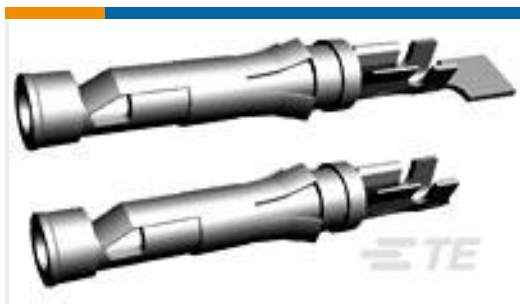

TE Part #66109-4
III+ SKT,26-24,30AU/FL,LP



TE Part #32562
PIDG Flanged Spade Tongue Terminals



TE Part #204510-1
RECEPT ASSY,104 POSN,AMPLIMITE

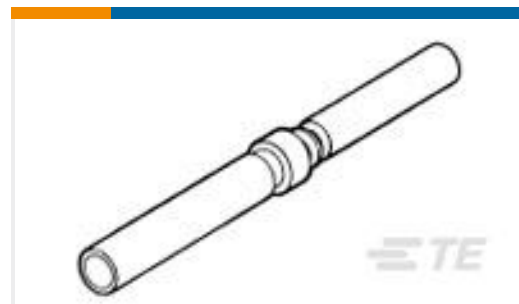

TE Part #204351-1
SZ 22 SOCKET CONTACT

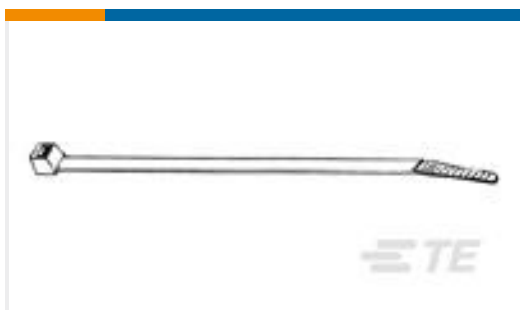

TE Part #1-604771-0
CABLE TIE, 4" BLACK, 100PK

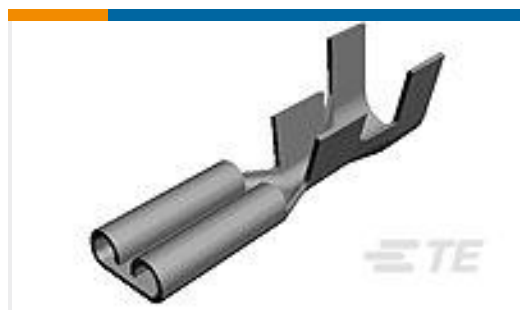

TE Part #42067-1
110 FATON REC 24-22 AWG TPBR



TE Part #322249
PG SPDFLG 22-16COMM 22-18MIL 6



TE Part #103308-2
014 LOPRO HDR SP 15DP



TE Part #2-34147-1
PG R 22-16 COMM 22-18 MIL 6

Documents



Product Drawings

[TERMINAL,PG SPD FLG 16-14 6](#)

English

CAD Files

3D PDF

3D

Customer View Model

[ENG_CVM_CVM_8-324165-1_P.2d_dxf.zip](#)

English

Customer View Model

[ENG_CVM_CVM_8-324165-1_P.3d_igs.zip](#)

English

Customer View Model

[ENG_CVM_CVM_8-324165-1_P.3d_stp.zip](#)

English

3D PDF

English

Customer View Model

[ENG_CVM_8-324165-1_H.2d_dxf.zip](#)

English

Customer View Model

[ENG_CVM_8-324165-1_H.3d_igs.zip](#)

English

Customer View Model

[ENG_CVM_8-324165-1_H.3d_stp.zip](#)

English

By downloading the CAD file I accept and agree to the [Terms and Conditions](#) of use.

Product Specifications

[Application Specification](#)

English