



PIDG

TE Internal #: 8-323994-3

Splices, Butt Splice, 26 – 22 AWG Wire Size, .12 – .4 mm² Wire Size, Serrated, .202 – .81 kcmil Wire Size, 202 – 810 CMA Wire Size, Copper, PIDG

[View on TE.com >](#)

Terminals & Splices > Splices > PIDG Butt Splices

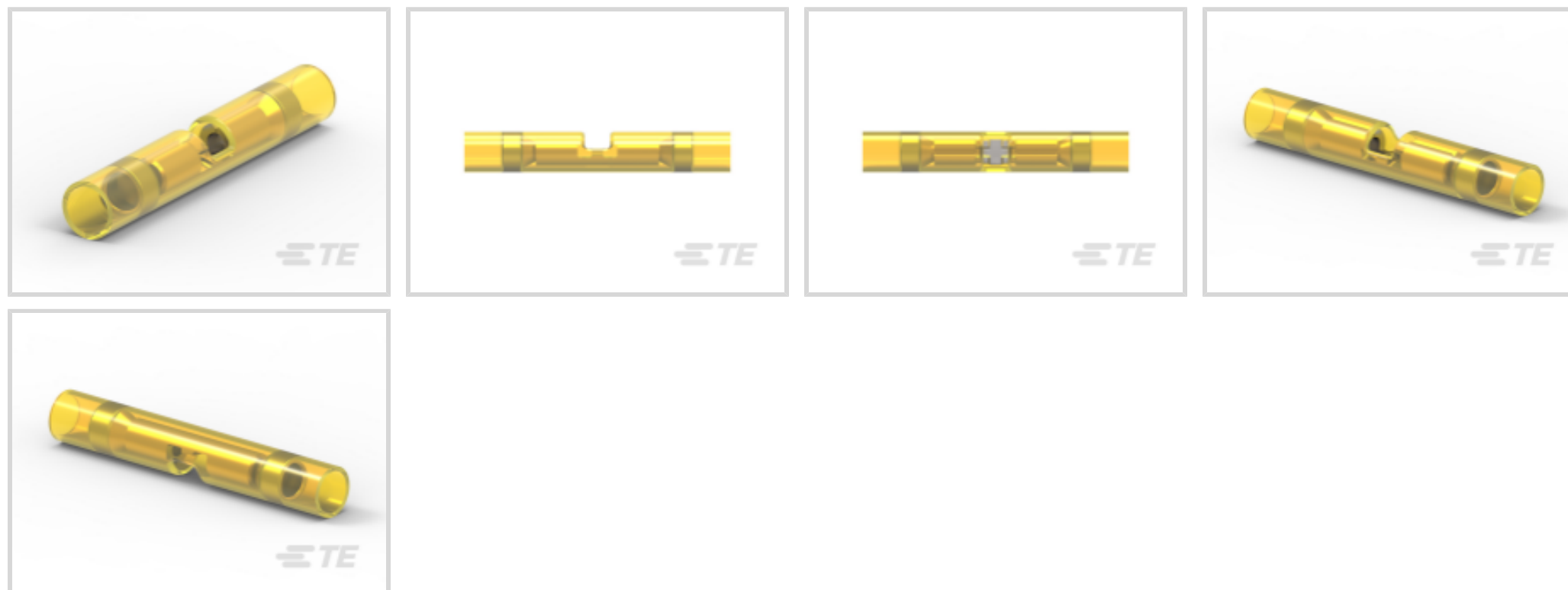

Wire Size: .12 – .4 mm²

Sealable: **No**

Splice Features: **Serrated**

Compatible Insulation Diameter Range: 2.08 mm [.082 in]

[All PIDG Butt Splices \(28\)](#)

Features

Product Type Features

Splice Accessory Type	Splice
Sealable	No
Splice Type	Butt Splice
Compatible With Discrete Wire Type	Stranded
Wire Insulation Support Retention Type	Insulation Support

Configuration Features

Number of Serrations	8
Compatible With Wire & Cable Type	Discrete Wire

Body Features

Product Weight	4.536 g
Insulation Material	Copper, Nylon
Splice Features	Serrated
Primary Product Color	Yellow - Translucent



Contact Features

Terminal Plating Material	Tin
Contact Base Material	Copper
Barrel Type	Closed

Mechanical Attachment

Wire Insulation Support	With
-------------------------	------

Dimensions

Wire Size	202 – 810 CMA
Compatible Insulation Diameter Range	2.08 mm[.082 in]
Terminal Material Thickness	.38 mm[.015 in]
Product Length	22.61 mm[.89 in]

Usage Conditions

Insulation Option	Fully Insulated
Operating Temperature Range	105 °C[221 °F]

Industry Standards

Government Qualified Splice	No
-----------------------------	----

Packaging Features

Packaging Quantity	25
Packaging Method	Loose Piece

Product Compliance

[For compliance documentation, visit the product page on TE.com>](#)

EU RoHS Directive 2011/65/EU	Compliant
EU ELV Directive 2000/53/EC	Compliant
China RoHS 2 Directive MIIT Order No 32, 2016	No Restricted Materials Above Threshold
EU REACH Regulation (EC) No. 1907/2006	Current ECHA Candidate List: JUNE 2023 (235) Candidate List Declared Against: JUNE 2023 (235) Does not contain REACH SVHC
Halogen Content	Low Halogen - Br, Cl, F, I < 900 ppm per homogenous material. Also BFR/CFR/PVC Free
Solder Process Capability	Not applicable for solder process capability

Product Compliance Disclaimer

This information is provided based on reasonable inquiry of our suppliers and represents our current actual knowledge based on the information they provided. This information is subject to change. The part numbers that TE has identified as EU RoHS compliant have a maximum concentration of 0.1% by weight in homogenous materials for lead, hexavalent chromium, mercury, PBB, PBDE, DBP, BBP, DEHP, DIBP, and 0.01% for cadmium, or qualify for an exemption to these limits as defined in the Annexes of Directive 2011/65/EU (RoHS2). Finished electrical and electronic equipment products will be CE marked as required by Directive 2011/65/EU. Components may not be CE marked. Additionally, the part numbers that TE has identified as EU ELV compliant have a maximum concentration of 0.1% by weight in homogenous materials for lead, hexavalent chromium, and mercury, and 0.01% for cadmium, or qualify for an exemption to these limits as defined in the Annexes of Directive 2000/53/EC (ELV). Regarding the REACH Regulation, the information TE provides on SVHC in articles for this part number is based on the latest European Chemicals Agency (ECHA) 'Guidance on requirements for substances in articles' posted at this URL: <https://echa.europa.eu/guidance-documents/guidance-on-reach>

Compatible Parts



REPRESENTATION ONLY

TE Part # 46121
DAHT PG PIDG 26-22 ASSY



TE Part # 59275
T-HEAD PIDG PG SH 26-20 ASSY



TE Part # 69344
PIDG 26-22 DIE SET

Also in the Series | PIDG



Compression Connectors(17)

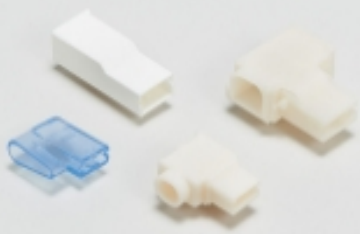

Crimp Terminal Housings(1)



Crimp Wire Pins, Tabs & Ferrules(41)



Hand Crimping Tools(2)



Knife Disconnects(11)



PCB Terminals(7)



Quick Disconnects(49)



Ring Terminals(611)

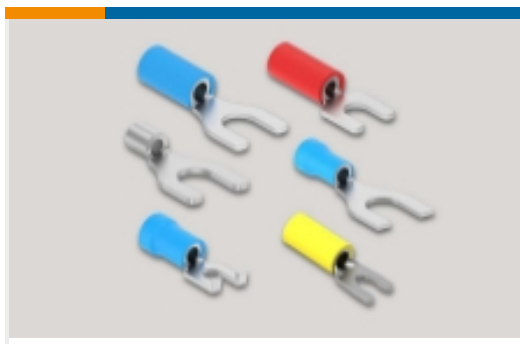

Spade Terminals(233)



Special Purpose Terminals(1)



Splices(46)

Customers Also Bought



TE Part #1011-233-0305
BKSHL, 3P, BLK, REC, ST, NW6/7.5/8.5 /10

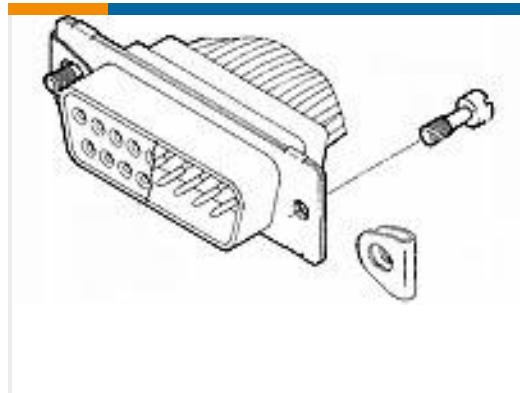

TE Part #211883-5
SCREW RETAINER KIT,AMPLIMITE



TE Part #794940-1
06P MINI UMNL CAP HSG



TE Part #204370-8
CONT PIN,SZ 22D,NON-MAG

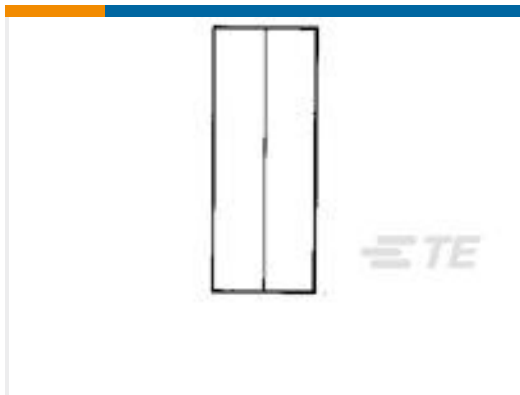

TE Part #34138-3
SOLIS, PARA 12-10 60/40 SN-PB



TE Part #3-641207-4
04P MTA156 HDR ASSY FL RA LF



TE Part #625159-000
D-110-35



TE Part #2302454-3
1-PORT MATENET FRAME,UTP, COD C



TE Part #2305974-2
2-PORT MATENET FRAME,UTP, COD B

Documents

Product Drawings

[PIDG 26-22 BUTT SM-PACK-25](#)

English

CAD Files

[3D PDF](#)

3D

[Customer View Model](#)

[ENG_CVM_CVM_8-323994-3_Y.2d_dxf.zip](#)



English

Customer View Model

[ENG_CVM_CVM_8-323994-3_Y.3d_igs.zip](#)

English

Customer View Model

[ENG_CVM_CVM_8-323994-3_Y.3d_stp.zip](#)

English

By downloading the CAD file I accept and agree to the [Terms and Conditions](#) of use.

Datasheets & Catalog Pages

[PIDG Terminals and Splices Quick Reference Guide](#)

English

[Standard Terminals & Splices](#)

English