

8-323914-1 ✓ ACTIVE



PIDG

TE Internal #: 8-323914-1

Closed Ring Tongue Terminal, 26 – 22 AWG, #4 / M2.5 Stud Size, 3.02 mm [.119 in] Stud Diameter, Closed Barrel, Straight, Tin, PIDG

[View on TE.com >](#)

Terminals & Splices > Ring Terminals > PIDG Ring Tongue Terminals

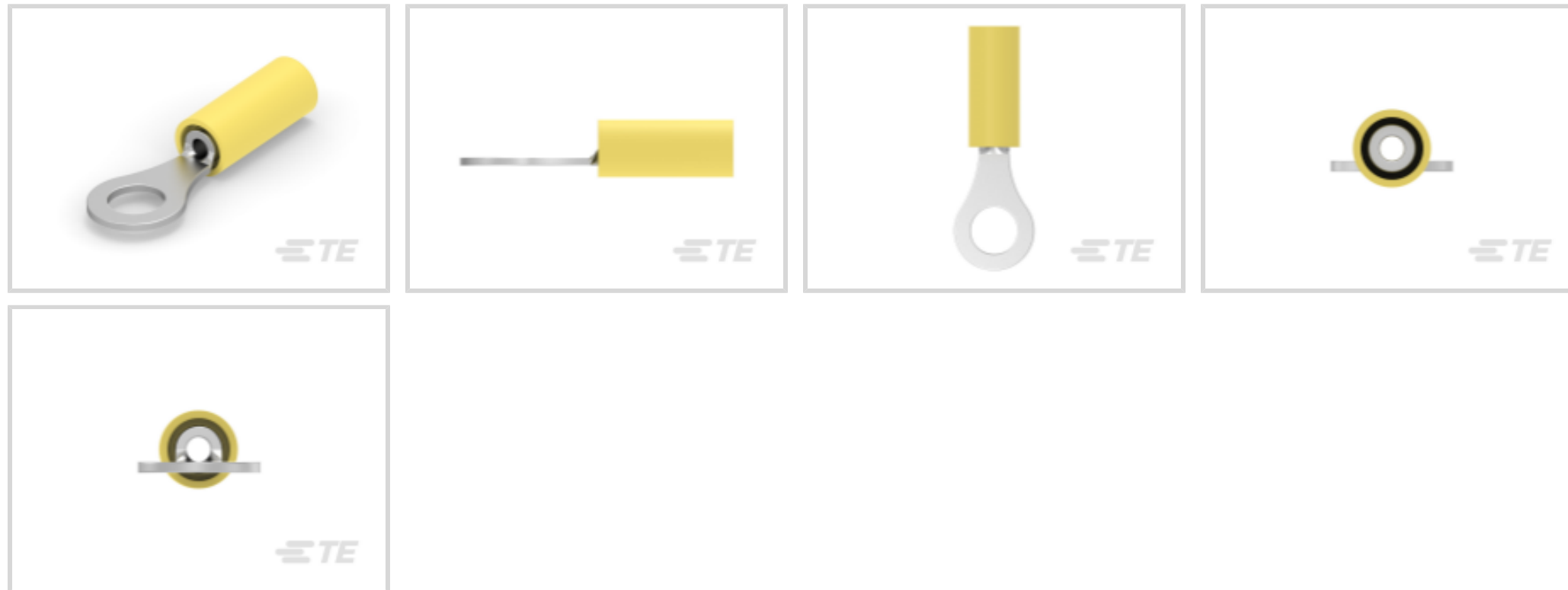

Ring Terminal Product Type: Closed Ring Tongue Terminal

Wire Size: 202 – 810 CMA

Stud Size: #4, M2.5

[All PIDG Ring Tongue Terminals \(418\)](#)

Features

Product Type Features

Terminal Features	Inspection Slot
Ring Terminal Product Type	Closed Ring Tongue Terminal
Stud Size	#4, M2.5
Sealable	No
Wire Insulation Support Retention Type	Insulation Support

Configuration Features

Number of Holes	1
-----------------	---

Electrical Characteristics

Voltage Rating	300 V
----------------	-------

Body Features

Product Weight	.286 g
----------------	--------

Contact Features

Military Part Class	Class II
Barrel Type	Closed



Terminal Orientation	Straight
----------------------	----------

Terminal Plating Material	Tin
---------------------------	-----

Mechanical Attachment

Wire Insulation Support	With
-------------------------	------

Dimensions

Wire Size	202 – 810 CMA
-----------	---------------

Stud Diameter	3.02 mm [.119 in]
---------------	-------------------

Tongue Thickness	.46 mm [.018 in]
------------------	------------------

Product Length	16.41 mm [.646 in]
----------------	--------------------

Compatible Insulation Diameter (Max)	2.08 mm [.082 in]
--------------------------------------	-------------------

Compatible Insulation Diameter Range	1.27 – 2.08 mm [.05 – .082 in]
--------------------------------------	--------------------------------

Usage Conditions

Insulation Option	Partially Insulated
-------------------	---------------------

Operating Temperature Range	105 °C [221 °F]
-----------------------------	-----------------

Operation/Application

Compatible With Wire Base Material	Copper
------------------------------------	--------

Compatible With Wire Plating Material	Tin
---------------------------------------	-----

Industry Standards

Government Qualified Terminal	No
-------------------------------	----

Packaging Features

Packaging Quantity	100
--------------------	-----

Packaging Method	Loose Piece
------------------	-------------

Product Compliance

[For compliance documentation, visit the product page on TE.com>](#)

EU RoHS Directive 2011/65/EU	Compliant
------------------------------	-----------

EU ELV Directive 2000/53/EC	Compliant
-----------------------------	-----------

China RoHS 2 Directive MIIT Order No 32, 2016	No Restricted Materials Above Threshold
---	---

EU REACH Regulation (EC) No. 1907/2006	Current ECHA Candidate List: JUNE 2023 (235) Candidate List Declared Against: JUNE 2023 (235) Does not contain REACH SVHC
--	---

Halogen Content

Low Halogen - Br, Cl, F, I < 900 ppm per homogenous material. Also BFR/CFR/PVC Free

Solder Process Capability

Not applicable for solder process capability

Product Compliance Disclaimer

This information is provided based on reasonable inquiry of our suppliers and represents our current actual knowledge based on the information they provided. This information is subject to change. The part numbers that TE has identified as EU RoHS compliant have a maximum concentration of 0.1% by weight in homogenous materials for lead, hexavalent chromium, mercury, PBB, PBDE, DBP, BBP, DEHP, DIBP, and 0.01% for cadmium, or qualify for an exemption to these limits as defined in the Annexes of Directive 2011/65/EU (RoHS2). Finished electrical and electronic equipment products will be CE marked as required by Directive 2011/65/EU. Components may not be CE marked. Additionally, the part numbers that TE has identified as EU ELV compliant have a maximum concentration of 0.1% by weight in homogenous materials for lead, hexavalent chromium, and mercury, and 0.01% for cadmium, or qualify for an exemption to these limits as defined in the Annexes of Directive 2000/53/EC (ELV). Regarding the REACH Regulation, the information TE provides on SVHC in articles for this part number is based on the latest European Chemicals Agency (ECHA) 'Guidance on requirements for substances in articles' posted at this URL: <https://echa.europa.eu/guidance-documents/guidance-on-reach>

Compatible Parts



Also in the Series | PIDG

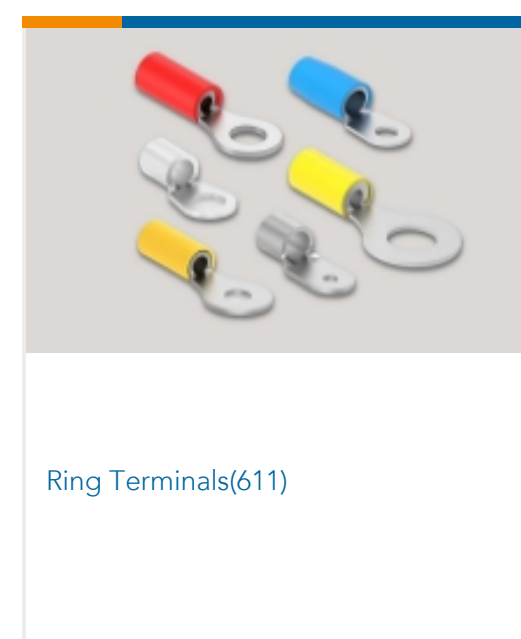
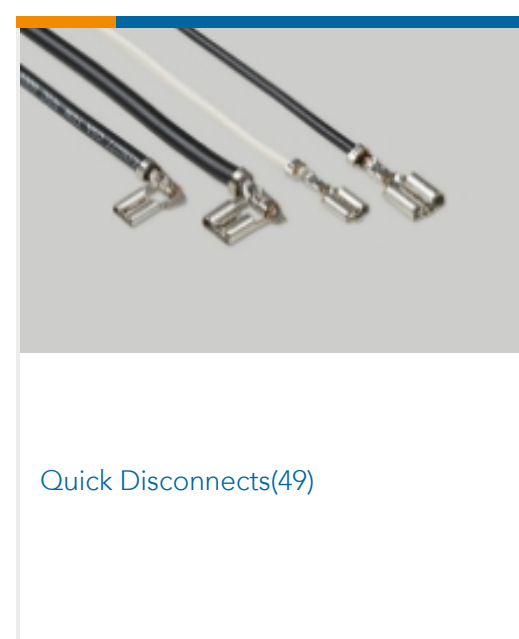
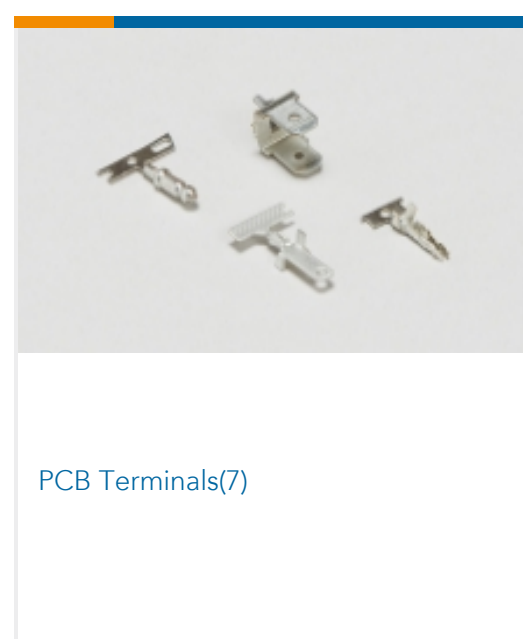
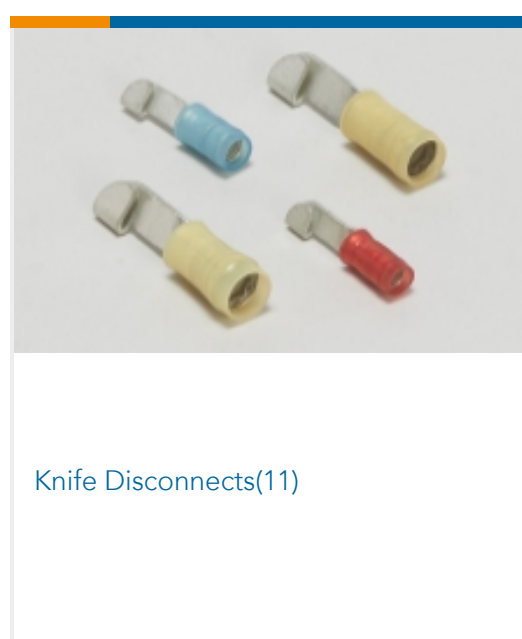
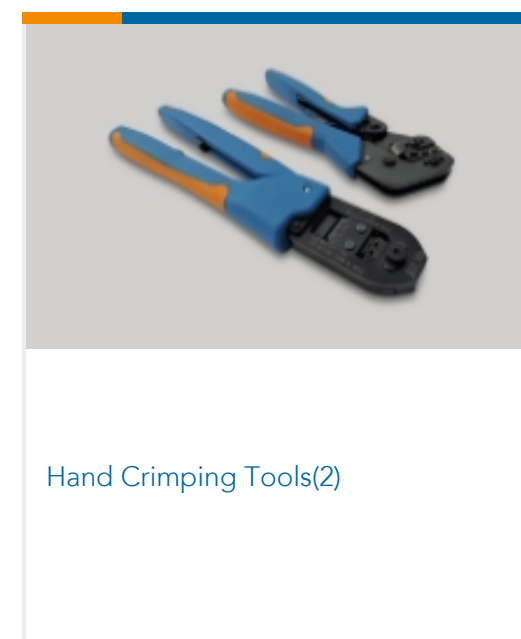
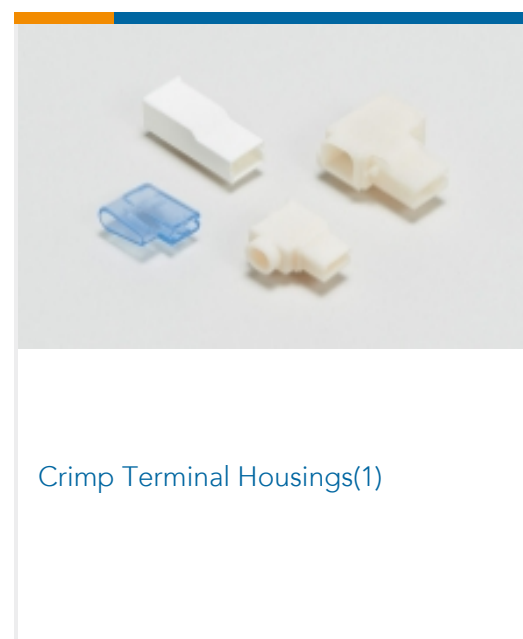
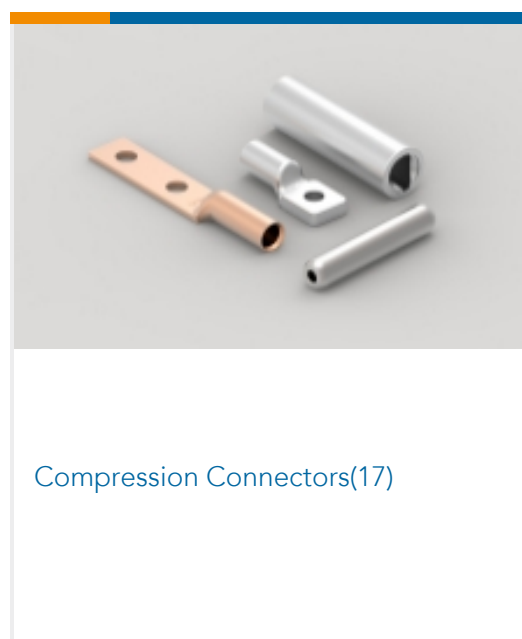

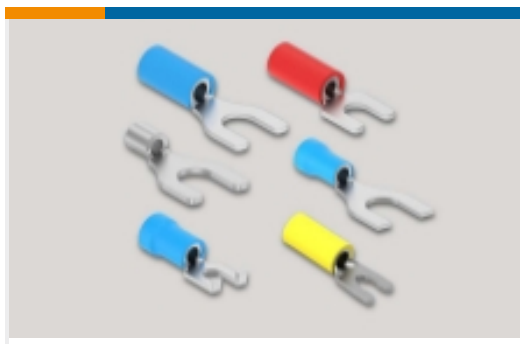

Spade Terminals(233)



Special Purpose Terminals(1)



Splices(46)

Customers Also Bought



TE Part #1-102387-1
60 MODIV HSG COMP DR .100 POL



TE Part #102387-3
16 MODIV HSG COMP DR .100 POL



TE Part #32859
TERMINAL,BUDG R 26-22 8



TE Part #2-87631-5
30 MODIV HSG COMP DR .100 POL

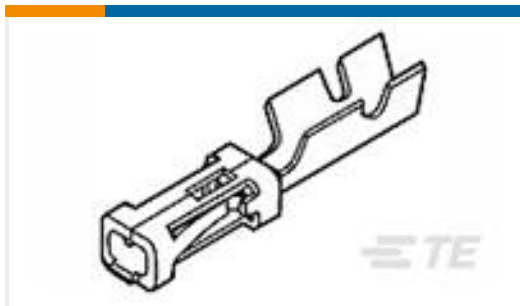

TE Part #6-87756-8
MOD IV RECP LP



TE Part #YDTS26W11-98SNV001
PLUG ASSY



TE Part #YDTS20F13-35PNV001
RECP ASSY



TE Part #YDTS20W17-26PNV001
RECP ASSY



TE Part #5207953-2
SCREWLOCK, ZN PLTD



TE Part #38941-16L
CONT PIN

Documents

Product Drawings

[TERMINAL,PIDG R 26-22 4](#)

English

CAD Files

[3D PDF](#)

3D

[Customer View Model](#)

[ENG_CVM_CVM_8-323914-1_W.2d_dxf.zip](#)



English

Customer View Model

[ENG_CVM_CVM_8-323914-1_W.3d_igs.zip](#)

English

Customer View Model

[ENG_CVM_CVM_8-323914-1_W.3d_stp.zip](#)

English

By downloading the CAD file I accept and agree to the [Terms and Conditions](#) of use.

Product Specifications

[Application Specification](#)

English

Product Environmental Compliance

[TE Material Declaration](#)

English