

8-31890-1 ✓ ACTIVE



PIDG

TE Internal #: 8-31890-1

Closed Ring Tongue Terminal, 22 AWG, M4 / #8 Stud Size, 4.17 mm [.164 in] Stud Diameter, Closed Barrel, Straight, Tin, Partially Insulated, PIDG

[View on TE.com >](#)

Terminals & Splices > Ring Terminals > PIDG Ring Tongue Terminals

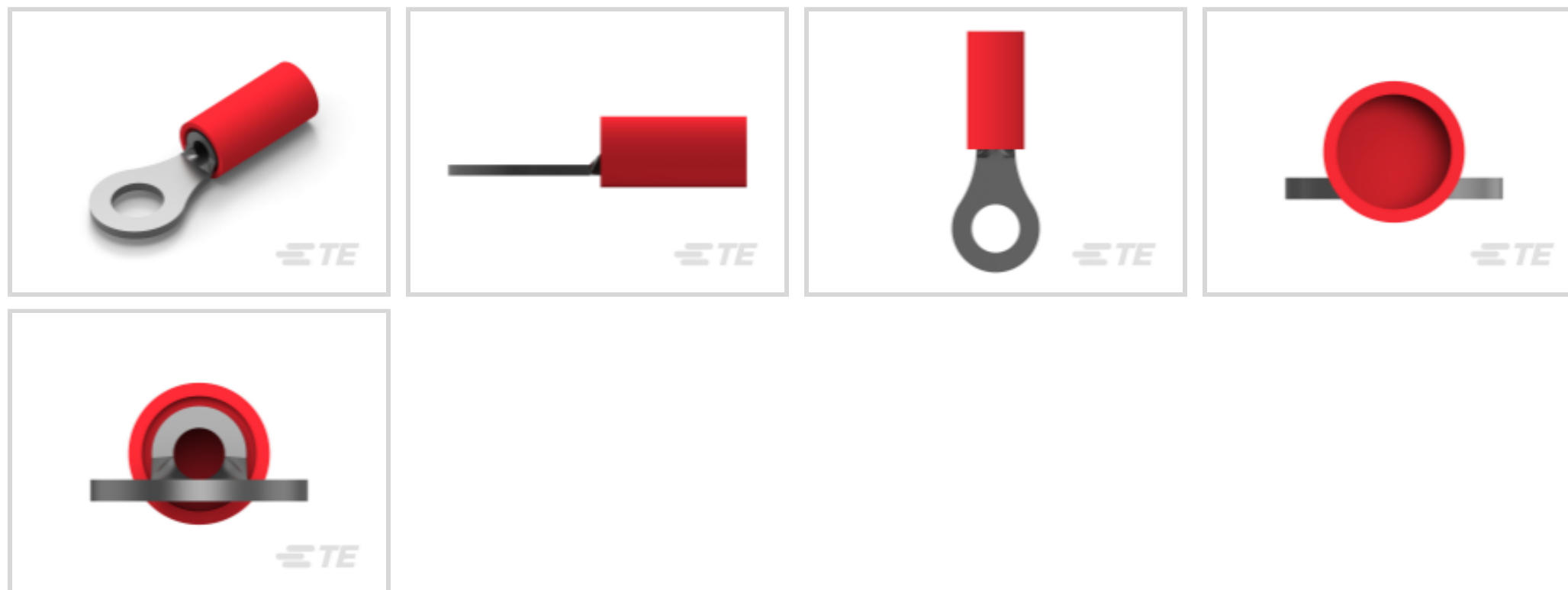

Ring Terminal Product Type: Closed Ring Tongue Terminal

Wire Size: 509 – 3260 CMA

Stud Size: #8, M4

[All PIDG Ring Tongue Terminals \(418\)](#)

Features

Product Type Features

Ring Terminal Product Type	Closed Ring Tongue Terminal
Stud Size	#8, M4
Wire Insulation Support Retention Type	Insulation Support

Configuration Features

Number of Holes	1
-----------------	---

Electrical Characteristics

Voltage Rating	300 V
----------------	-------

Body Features

Product Weight	.839 g
Insulation Sleeve Color	Red
Stripe Color	Red

Contact Features

Barrel Type	Closed
-------------	--------



Terminal Orientation	Straight
----------------------	----------

Terminal Plating Material	Tin
---------------------------	-----

Mechanical Attachment

Wire Insulation Support	With
-------------------------	------

Dimensions

Wire Size	509 – 3260 CMA
-----------	----------------

Stud Diameter	4.17 mm [.164 in]
---------------	-------------------

Tongue Thickness	.84 mm [.033 in]
------------------	------------------

Product Length	21.44 mm [.844 in]
----------------	--------------------

Compatible Insulation Diameter (Max)	3.56 mm [.14 in]
--------------------------------------	------------------

Compatible Insulation Diameter Range	2.67 – 3.56 mm [.105 – .14 in]
--------------------------------------	--------------------------------

Usage Conditions

Insulation Option	Partially Insulated
-------------------	---------------------

Operating Temperature Range	105 °C [221 °F]
-----------------------------	-----------------

Operation/Application

Compatible With Wire Base Material	Copper
------------------------------------	--------

Compatible With Wire Plating Material	Tin
---------------------------------------	-----

Industry Standards

Government Qualified Terminal	No
-------------------------------	----

Packaging Features

Packaging Quantity	50
--------------------	----

Packaging Method	Loose Piece
------------------	-------------

Product Compliance

[For compliance documentation, visit the product page on TE.com>](#)

EU RoHS Directive 2011/65/EU	Compliant
------------------------------	-----------

EU ELV Directive 2000/53/EC	Compliant
-----------------------------	-----------

China RoHS 2 Directive MIIT Order No 32, 2016	No Restricted Materials Above Threshold
---	---

EU REACH Regulation (EC) No. 1907/2006	Current ECHA Candidate List: JUNE 2023 (235) Candidate List Declared Against: JUNE 2023 (235) Does not contain REACH SVHC
--	---













Halogen Content	Low Halogen - Br, Cl, F, I < 900 ppm per homogenous material. Also BFR/CFR/PVC Free
Solder Process Capability	Not applicable for solder process capability

Product Compliance Disclaimer

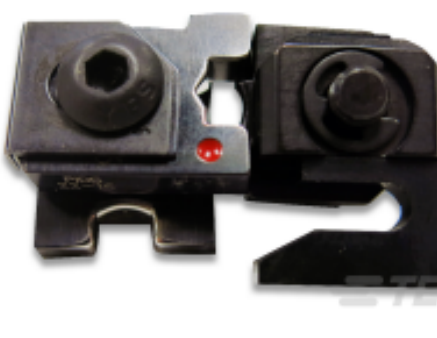
This information is provided based on reasonable inquiry of our suppliers and represents our current actual knowledge based on the information they provided. This information is subject to change. The part numbers that TE has identified as EU RoHS compliant have a maximum concentration of 0.1% by weight in homogenous materials for lead, hexavalent chromium, mercury, PBB, PBDE, DBP, BBP, DEHP, DIBP, and 0.01% for cadmium, or qualify for an exemption to these limits as defined in the Annexes of Directive 2011/65/EU (RoHS2). Finished electrical and electronic equipment products will be CE marked as required by Directive 2011/65/EU. Components may not be CE marked. Additionally, the part numbers that TE has identified as EU ELV compliant have a maximum concentration of 0.1% by weight in homogenous materials for lead, hexavalent chromium, and mercury, and 0.01% for cadmium, or qualify for an exemption to these limits as defined in the Annexes of Directive 2000/53/EC (ELV). Regarding the REACH Regulation, the information TE provides on SVHC in articles for this part number is based on the latest European Chemicals Agency (ECHA) 'Guidance on requirements for substances in articles' posted at this URL: <https://echa.europa.eu/guidance-documents/guidance-on-reach>

Compatible Parts

 <p>TE Part # 59824-1 TETRA-CRIMP PIDG PG FASTON 22-10 ASSY</p>	 <p>TE Part # 47386 DAHT PG PIDG 26-16 ASSY</p>	 <p>TE Part # 59250 T-HEAD PIDG 26-14 ASSY</p>	 <p>TE Part # 58423-1 DIE, RBY IS9252</p>
 <p>TE Part # 58433-3 PRO CR ASSY, RBY IS9252</p>	 <p>TE Part # 539691-2 ERGO DIE R.B.Y</p>	 <p>TE Part # 2063030-1 SDE DIESET, RBY, UL</p>	 <p>TE Part # 47806-2 DIES PIDG 22-16 DIE SET</p>
 <p>TE Part # 59300 T-HEAD PIDG PG 26-16 ASSY</p>	 <p>TE Part # 169400 CERTI-LOK FRAME W/O DIES</p>	 <p>TE Part # 1SET191001R0000 CRIMP-HT</p>	 <p>TE Part # 1SET191002R0000 TET CRIMP-HT</p>



Also in the Series | PIDG

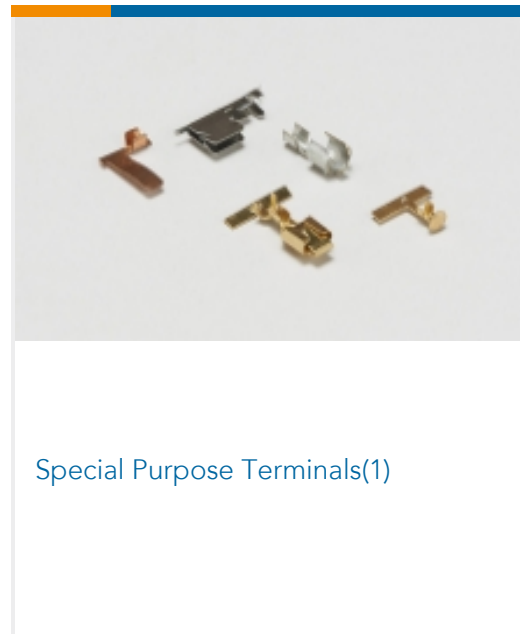
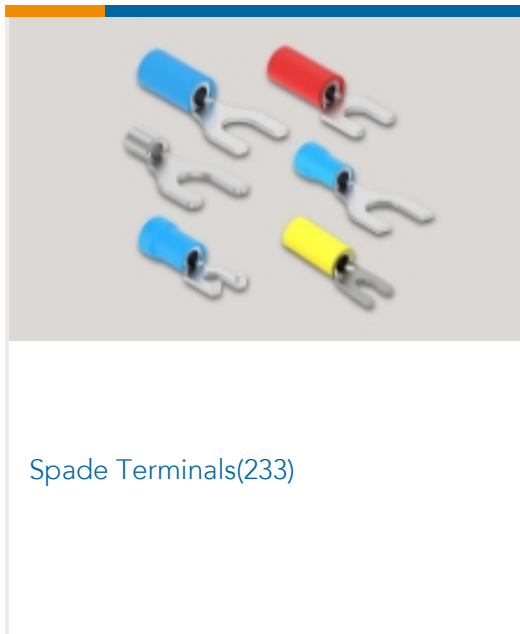
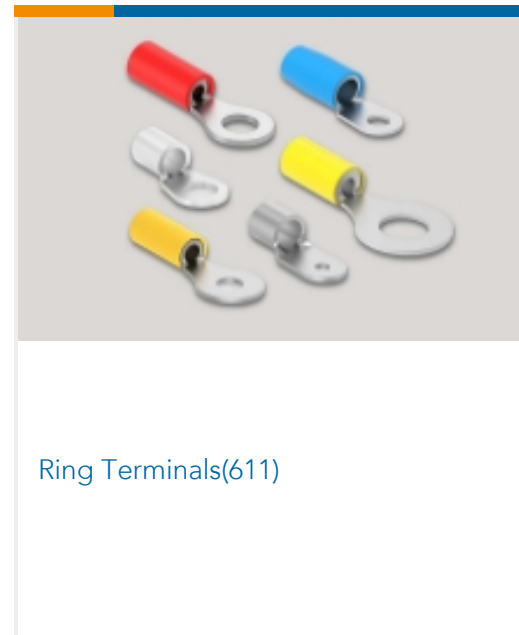
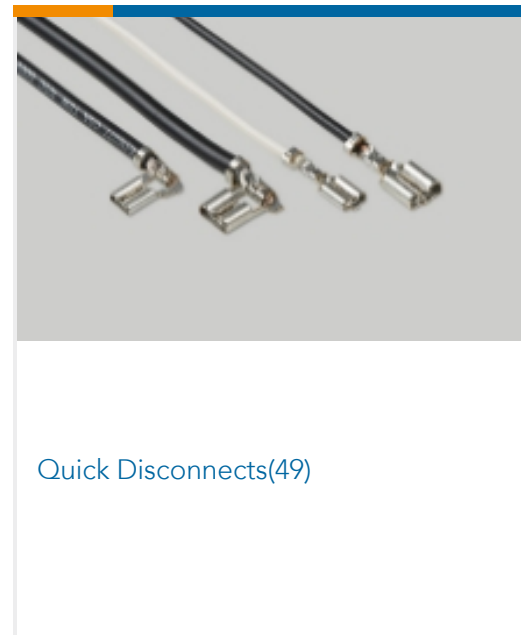
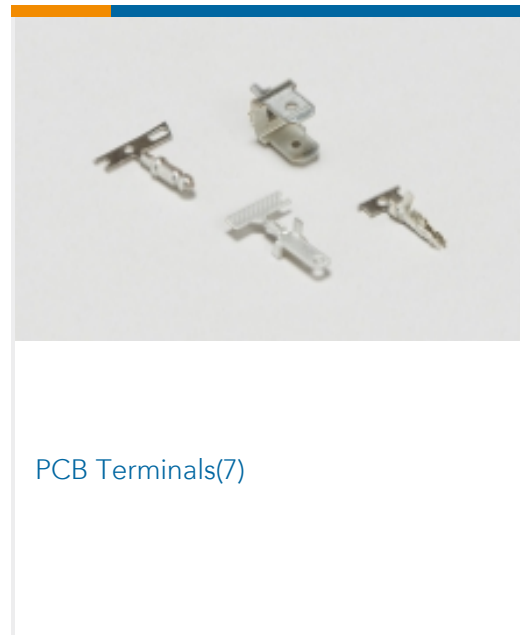
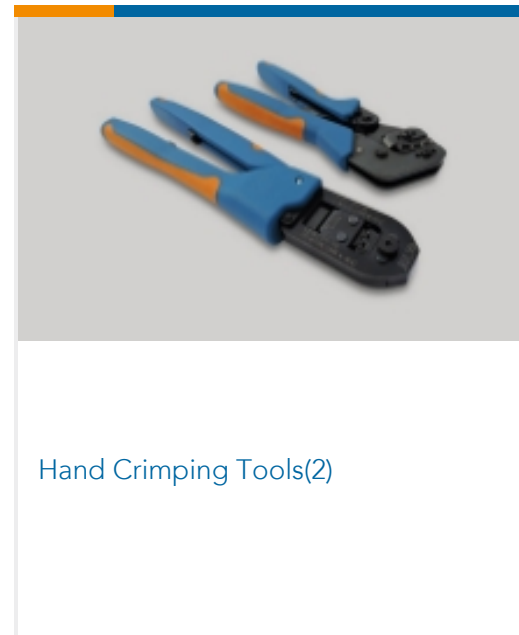
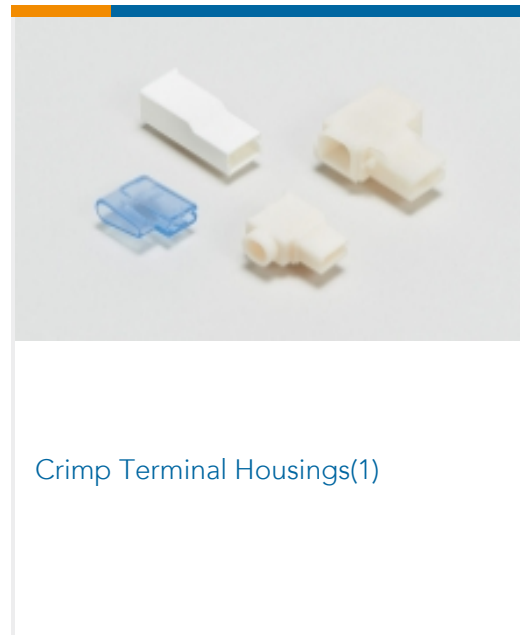
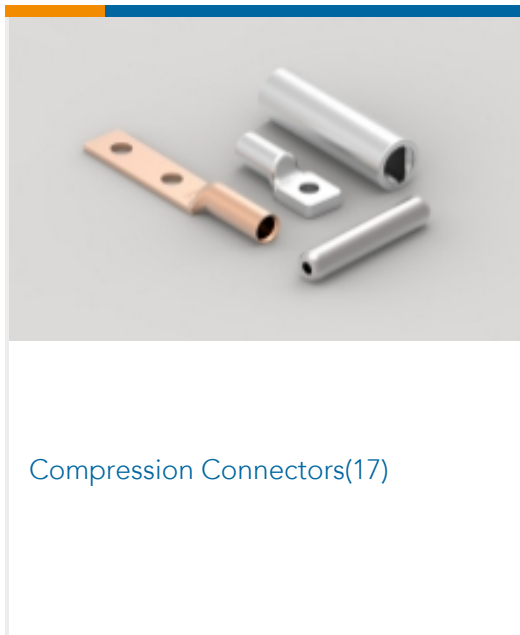

Customers Also Bought

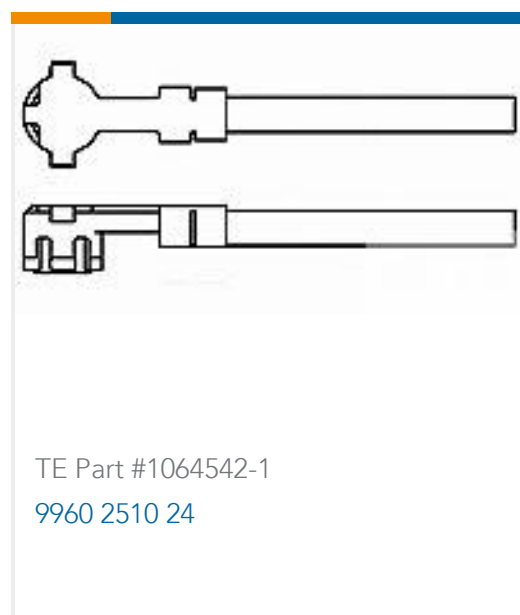
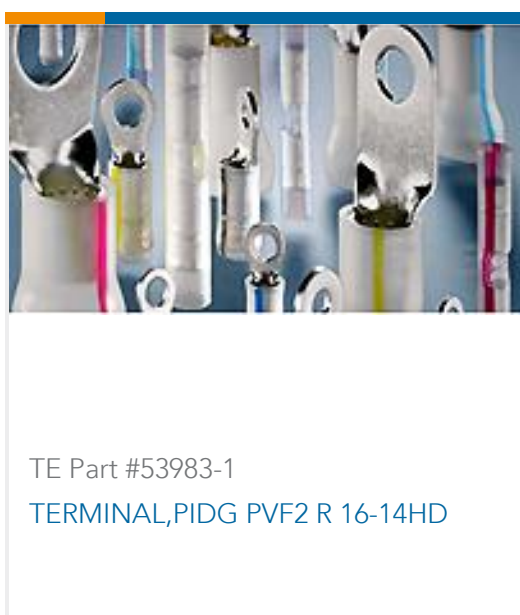



Documents

Product Drawings

[PIDG R 22-16 COMM 22-18 MIL 8](#)

English

CAD Files

Customer View Model

[ENG_CVM_CVM_8-31890-1_AF.2d_dxf.zip](#)

English

[3D PDF](#)

3D

Customer View Model

[ENG_CVM_CVM_8-31890-1_AF.3d_igs.zip](#)

English

Customer View Model

[ENG_CVM_CVM_8-31890-1_AF.3d_stp.zip](#)

English

By downloading the CAD file I accept and agree to the [Terms and Conditions](#) of use.

Product Specifications

[Application Specification](#)

English

Product Environmental Compliance

[PIDG R 22-16 COMM 22-18 MIL 8](#)

English

[PIDG R 22-16 COMM 22-18 MIL 8](#)

English

Agency Approvals

[UL Report](#)

English