



Connectors > Connector Accessories > Connector Backshells > CPC Cable Clamps



Connector Backshell Product Style: **Unscreened**

Connector Backshell Product Type: **Cable Clamp & Body**

Cable Entry Diameter: **17.86 mm [ .703 in ]**

Primary Product Material: **Nylon**

Body Orientation: **Right Angle**

[All CPC Cable Clamps \(25\)](#)

## Features

### Product Type Features

Connector Backshell Product Style	Unscreened
Connector Backshell Product Type	Cable Clamp & Body

### Body Features

Primary Product Color	Black
Primary Product Material	Nylon

### Mechanical Attachment

Thread Size	1-3/8-18 UNEF-2B
-------------	------------------

### Housing Features

Body Orientation	Right Angle
Compatible With Connector Shape	Circular

### Dimensions

Cable Entry Diameter	17.86 mm[.703 in]
----------------------	-------------------



### Operation/Application

Compatible With Connector Shell Size	23
--------------------------------------	----

### Industry Standards

UL Flammability Rating	UL 94V-0
------------------------	----------

### Packaging Features

Packaging Quantity	1
Packaging Method	Individual

### Product Compliance

[For compliance documentation, visit the product page on TE.com>](#)

EU RoHS Directive 2011/65/EU	Compliant
EU ELV Directive 2000/53/EC	Compliant
China RoHS 2 Directive MIIT Order No 32, 2016	No Restricted Materials Above Threshold
EU REACH Regulation (EC) No. 1907/2006	Current ECHA Candidate List: JUNE 2023 (235) Candidate List Declared Against: JUNE 2023 (235) Does not contain REACH SVHC
Halogen Content	Not Low Halogen - contains Br or Cl > 900 ppm.
Solder Process Capability	Not applicable for solder process capability

#### Product Compliance Disclaimer

This information is provided based on reasonable inquiry of our suppliers and represents our current actual knowledge based on the information they provided. This information is subject to change. The part numbers that TE has identified as EU RoHS compliant have a maximum concentration of 0.1% by weight in homogenous materials for lead, hexavalent chromium, mercury, PBB, PBDE, DBP, BBP, DEHP, DIBP, and 0.01% for cadmium, or qualify for an exemption to these limits as defined in the Annexes of Directive 2011/65/EU (RoHS2). Finished electrical and electronic equipment products will be CE marked as required by Directive 2011/65/EU. Components may not be CE marked. Additionally, the part numbers that TE has identified as EU ELV compliant have a maximum concentration of 0.1% by weight in homogenous materials for lead, hexavalent chromium, and mercury, and 0.01% for cadmium, or qualify for an exemption to these limits as defined in the Annexes of Directive 2000/53/EC (ELV). Regarding the REACH Regulation, the information TE provides on SVHC in articles for this part number is based on the latest European Chemicals Agency (ECHA) 'Guidance on requirements for substances in articles' posted at this URL: <https://echa.europa.eu/guidance-documents/guidance-on-reach>

### Compatible Parts



TE Part # CAT-AM71-C83998BB  
CPC SERIES 3



TE Part # CAT-AM71-C83998M  
CPC Connectors, Series 2



TE Part # CAT-AM71-C83998J  
Cable/Panel Mount Connector, CPC Series 1



TE Part # CAT-AM71-C83998CC  
CPC Connector Housing, Series 4



TE Part # CAT-AM71-C83998F  
Connectors with Posted Pin Contacts, CPC Series 1



TE Part # CAT-AM71-C83998E  
Connectors with Posted Contacts, CPC Series 2



TE Part # CAT-AM71-C83998K  
Circular Connector, Environmentally Sealed, CPC Series 6



TE Part # CAT-AM71-C83998Y  
One-Piece Connector, Sealed, CPC Series 1



TE Part # 206306-2  
23-37 F H RECEPT REV SEX



TE Part # 206306-5  
CPC RECEPT ASSEMBLY SIZE 23-37



TE Part # 206306-1  
23-37 RECEPT REV SEX



TE Part # 1-206934-1  
CPC RECPT ASSEMBLY SIZE 23-37



TE Part # CAT-AM71-C83998GG  
Connectors with Posted Pin Contacts, Right Angle, CPC Series 1



TE Part # 1-206934-7  
CPC RECPT ASSEMBLY SIZE 23-37

Also in the Series | AMP CPC



Circular Connector Adapters(7)



Circular Connector Hardware(3)



Circular Connector Keying Plugs(2)



Circular Power Connectors(458)

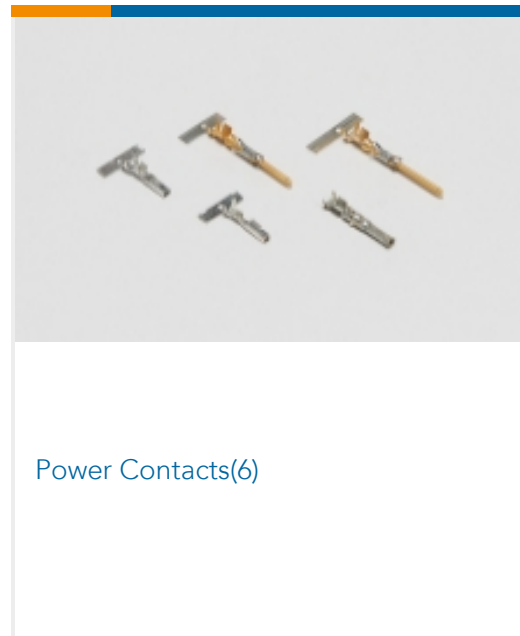
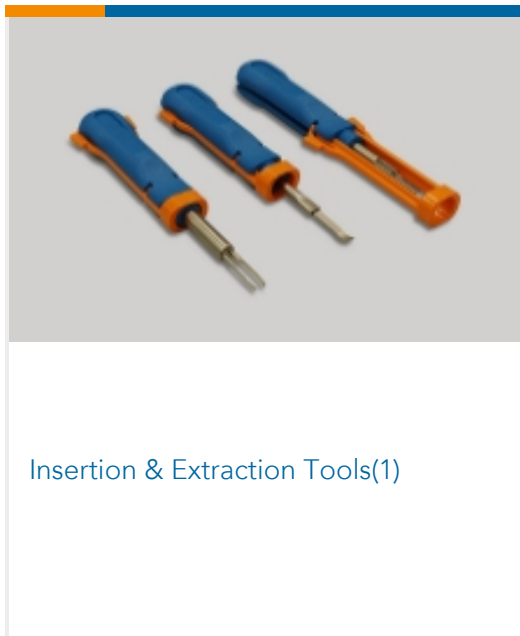
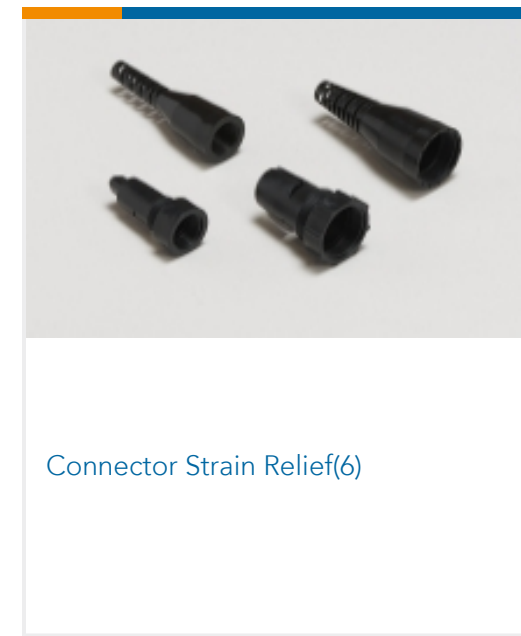
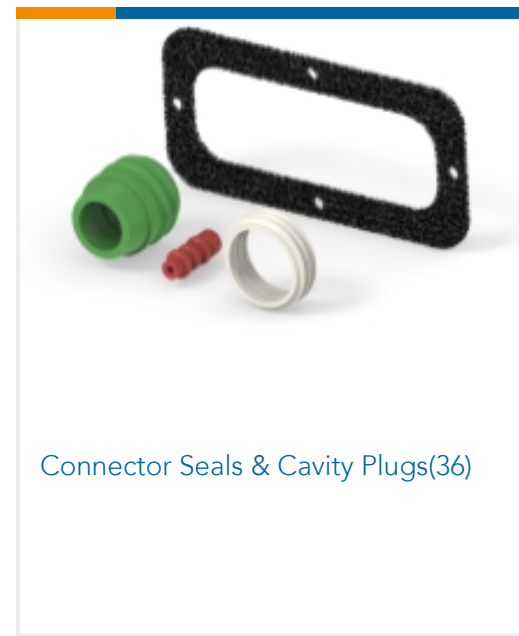
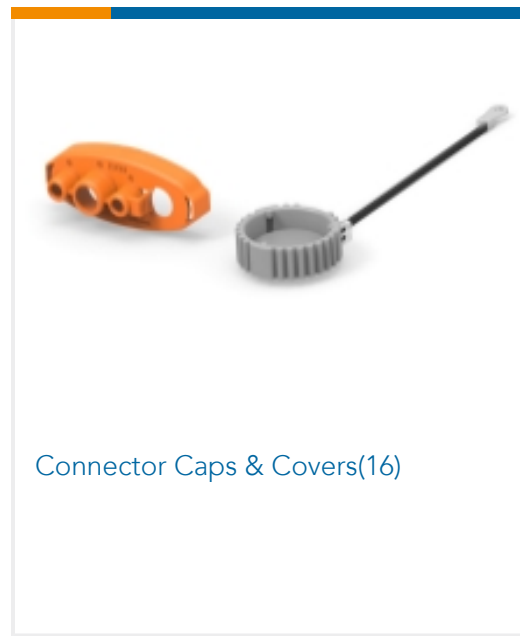
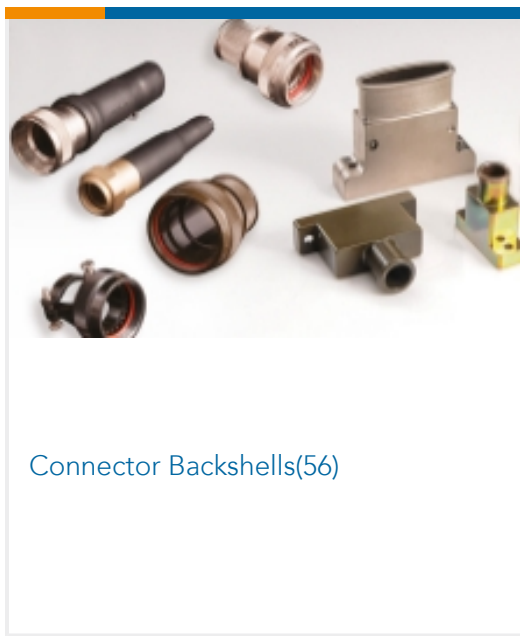

### Customers Also Bought

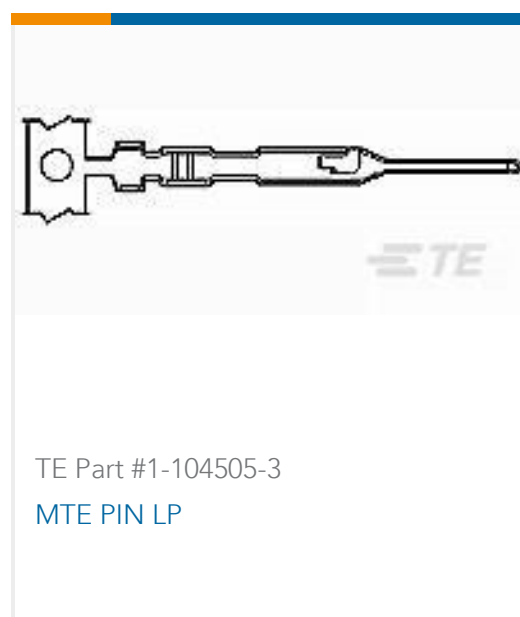

### Documents



### Product Drawings

[R/A STRN RELIEF KIT,SZ 23,CPC](#)

English

---

### CAD Files

Customer View Model

[ENG\\_CVM\\_CVM\\_796382-2\\_D.2d\\_dxf.zip](#)

English

**3D PDF**

3D

Customer View Model

[ENG\\_CVM\\_CVM\\_796382-2\\_D.3d\\_igs.zip](#)

English

Customer View Model

[ENG\\_CVM\\_CVM\\_796382-2\\_D.3d\\_stp.zip](#)

English

By downloading the CAD file I accept and agree to the [Terms and Conditions](#) of use.

---

### Product Specifications

[Application Specification](#)

English

---

### Instruction Sheets

[Instruction Sheet \(U.S.\)](#)

English