

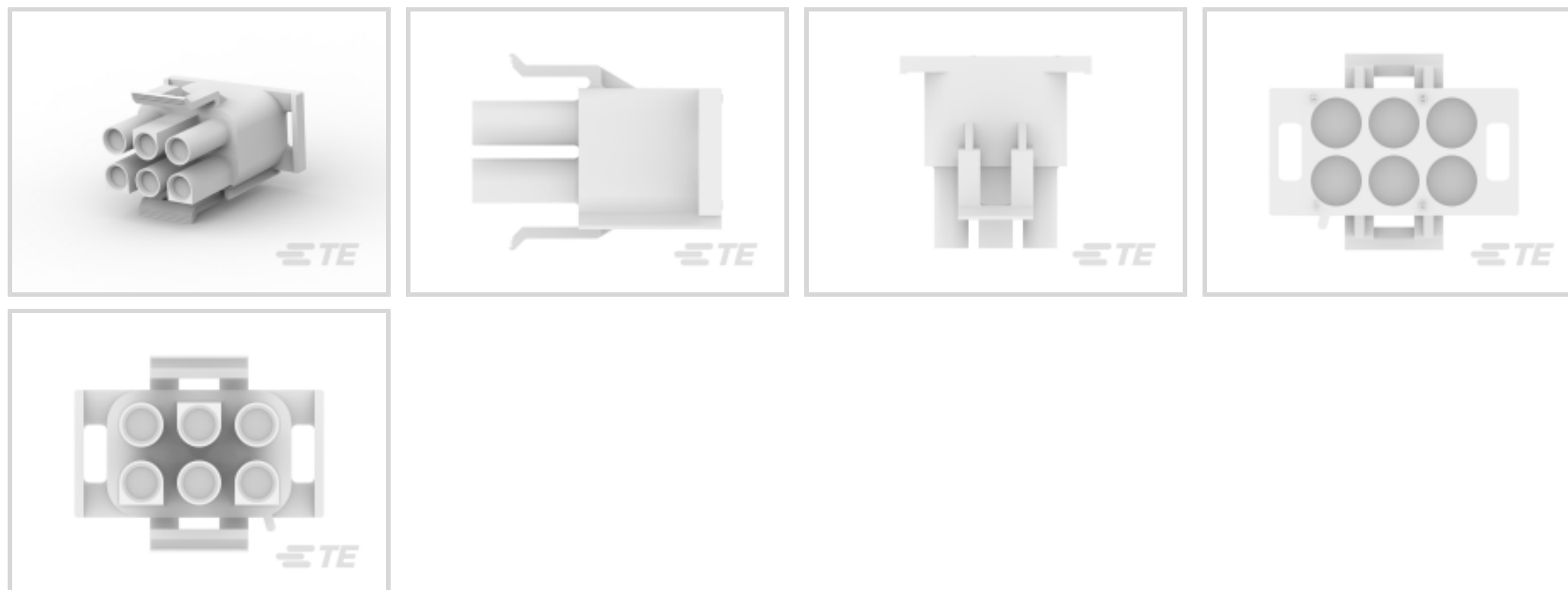

Connectors > Power Connectors > Rectangular Power > Rectangular Power Connectors



Rectangular Power Connector Type: **Housing**

Connector & Housing Type: **Plug**

Connector System: **Wire-to-Board, Wire-to-Wire**

Number of Positions: **6**

Centerline (Pitch): **6.35 mm [.25 in]**

## Features

### Product Type Features

Rectangular Power Connector Type	Housing
Connector & Housing Type	Plug
Connector System	Wire-to-Board, Wire-to-Wire
Sealable	No
Connector & Contact Terminates To	Wire & Cable

### Configuration Features

Number of Positions	6
Number of Rows	2

### Electrical Characteristics

Operating Voltage	600 VAC
-------------------	---------

### Contact Features

Multiple Contact Types	Without
Contact Layout	Matrix
Contact Retention Within Housing	Without



Contact Type	Socket
--------------	--------

### Termination Features

Termination Method to Wire & Cable	Crimp
------------------------------------	-------

### Mechanical Attachment

Connector Mounting Type	Cable Mount (Free-Hanging)
-------------------------	----------------------------

### Housing Features

Centerline (Pitch)	6.35 mm [.25 in]
--------------------	------------------

Housing Color	Natural
---------------	---------

Housing Material	Nylon
------------------	-------

### Dimensions

Row-to-Row Spacing	6.35 mm [.25 in]
--------------------	------------------

### Usage Conditions

Operating Temperature Range	-55 – 105 °C [-67 – 221 °F]
-----------------------------	-----------------------------

### Operation/Application

Circuit Application	Power & Signal
---------------------	----------------

### Industry Standards

UL Rating	Recognized
-----------	------------

Agency/Standard	UL, VDE
-----------------	---------

Approved Standards	UL E28476
--------------------	-----------

UL Flammability Rating	UL 94V-2
------------------------	----------

Glow Wire Rating	GWT 750°C (Without Flame)
------------------	---------------------------

### Packaging Features

Packaging Quantity	1
--------------------	---

Packaging Method	Package
------------------	---------

### Product Compliance

[For compliance documentation, visit the product page on TE.com>](#)

EU RoHS Directive 2011/65/EU	Compliant
------------------------------	-----------

EU ELV Directive 2000/53/EC	Compliant
-----------------------------	-----------

China RoHS 2 Directive MIIT Order No 32, 2016	No Restricted Materials Above Threshold
---	---

EU REACH Regulation (EC) No. 1907/2006	Current ECHA Candidate List: JUNE 2023 (235)
--	--



Candidate List Declared Against: JUNE 2023 (235)  
Does not contain REACH SVHC

Halogen Content

Not Low Halogen - contains Br or Cl > 900 ppm.

Solder Process Capability

Not applicable for solder process capability

Product Compliance Disclaimer

This information is provided based on reasonable inquiry of our suppliers and represents our current actual knowledge based on the information they provided. This information is subject to change. The part numbers that TE has identified as EU RoHS compliant have a maximum concentration of 0.1% by weight in homogenous materials for lead, hexavalent chromium, mercury, PBB, PBDE, DBP, BBP, DEHP, DIBP, and 0.01% for cadmium, or qualify for an exemption to these limits as defined in the Annexes of Directive 2011/65/EU (RoHS2). Finished electrical and electronic equipment products will be CE marked as required by Directive 2011/65/EU. Components may not be CE marked. Additionally, the part numbers that TE has identified as EU ELV compliant have a maximum concentration of 0.1% by weight in homogenous materials for lead, hexavalent chromium, and mercury, and 0.01% for cadmium, or qualify for an exemption to these limits as defined in the Annexes of Directive 2000/53/EC (ELV). Regarding the REACH Regulation, the information TE provides on SVHC in articles for this part number is based on the latest European Chemicals Agency (ECHA) 'Guidance on requirements for substances in articles' posted at this URL: <https://echa.europa.eu/guidance-documents/guidance-on-reach>

## Compatible Parts



TE Part # 1-480705-2  
06P UNML CAP HSG RED



TE Part # 1644055-1  
UNIV MATE-N-LOK HOUSING 6W



TE Part # 1586860-1  
06P UMNL CAP HSG, GW



TE Part # 770027-1  
06P UMNLII IN-LINE CAP HSG KIT



TE Part # 926682-3  
06P UNIV.M-N-L.HSG.



TE Part # 1586846-1  
06P UMNL PLUG HSG NATL, GW



TE Part # 1-480705-9  
06P UMNL CAP HSG BLK



TE Part # 350781-1  
06P UMNL CAP HSG



TE Part # 1-480704-9  
06P UMNL PLUG HSG BLK



TE Part # 350715-1  
06P UMNL PLUG HSG



TE Part # 1-480705-0  
06P UMNL CAP HSG NATL



TE Part # 1-480704-0  
06P UMNL PLUG HSG NATL



Also in the Series | **Universal MATE-N-LOK**

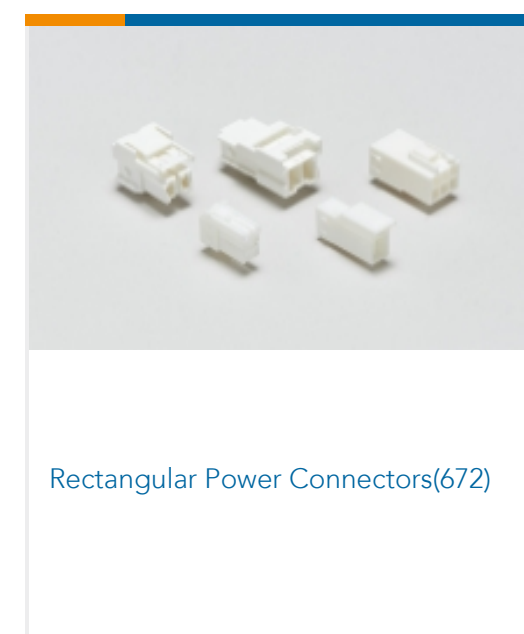
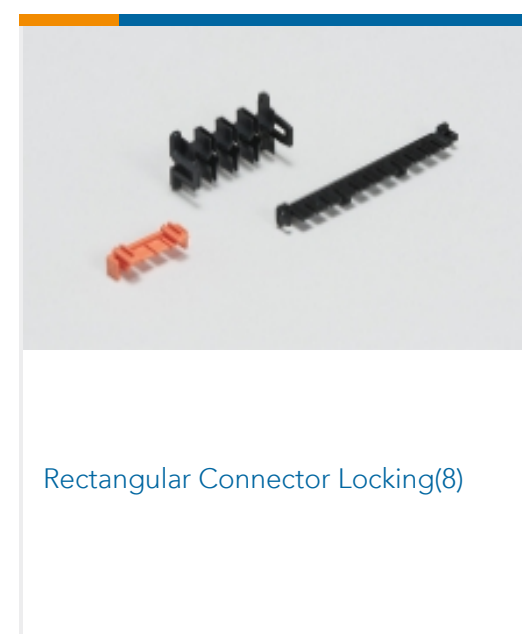
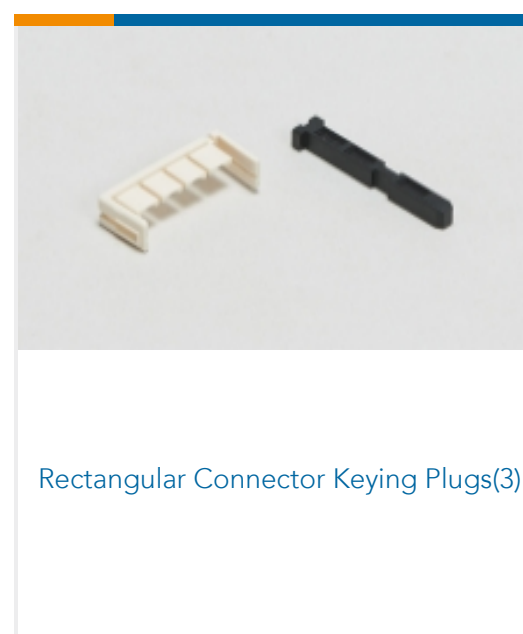
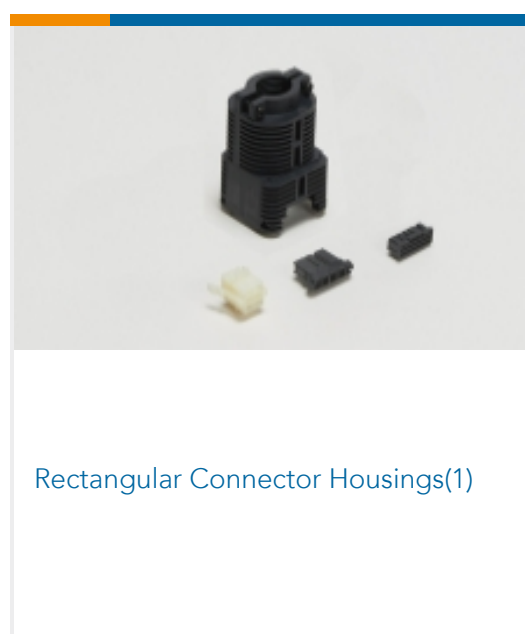
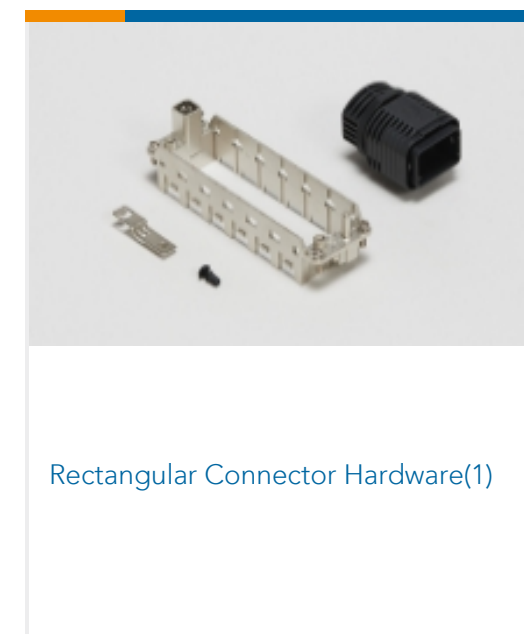
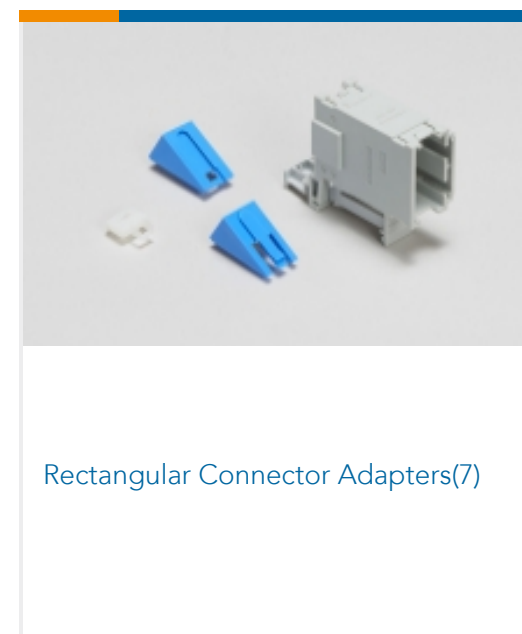
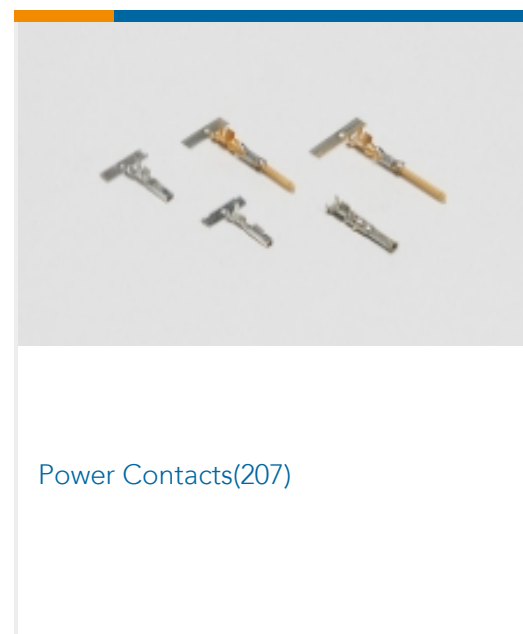
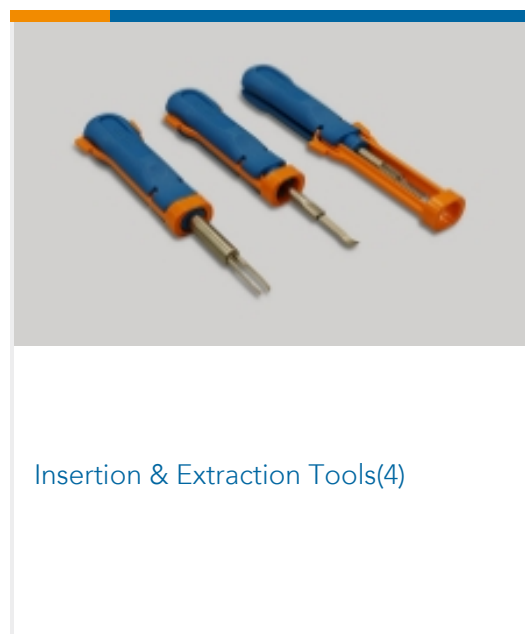
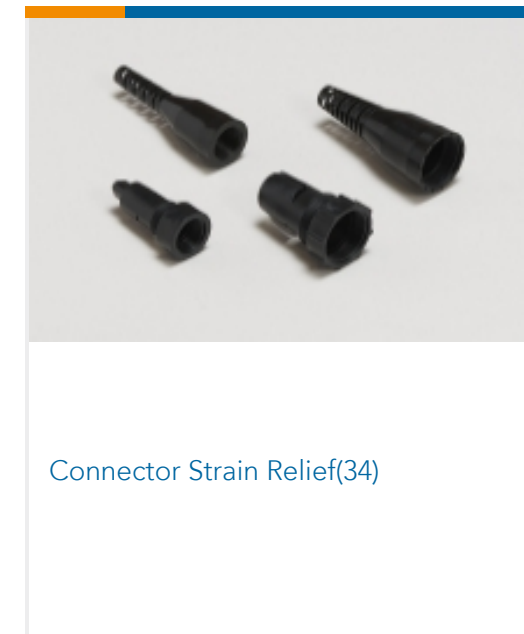
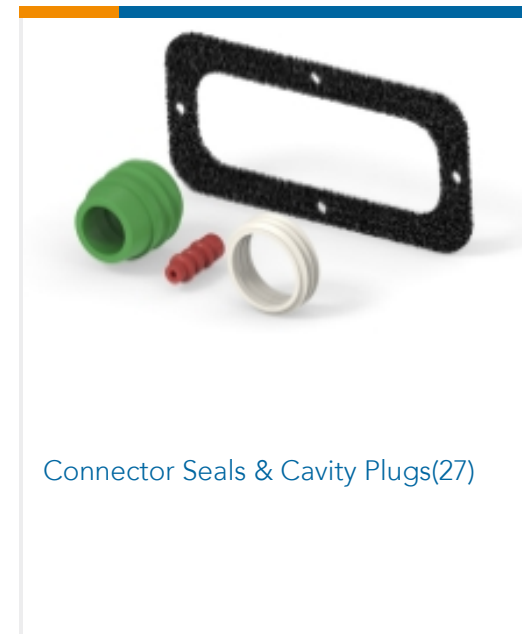
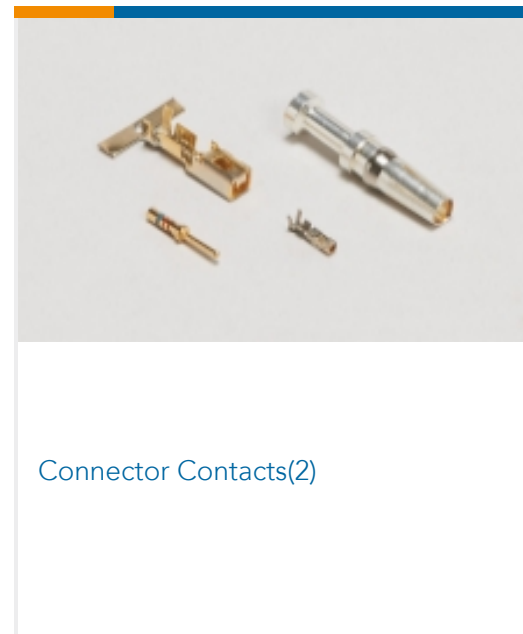
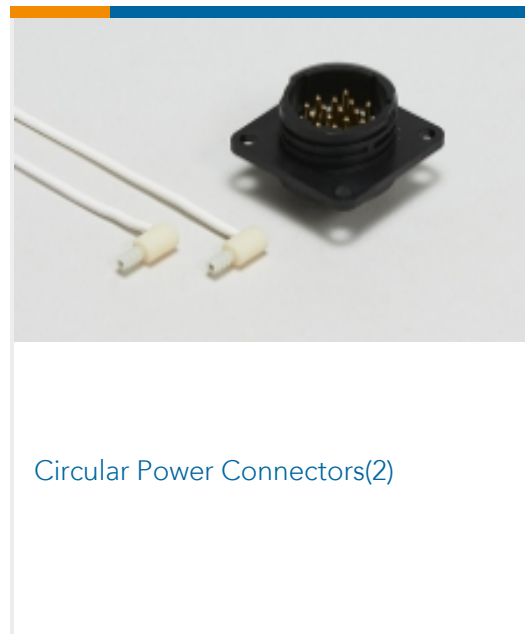

Customers Also Bought



TE Part #292174-4  
CT Box Header SMT: Vert, Shrouded



TE Part #1-292173-5  
AMP COMMON TERMINATION HEADERS



TE Part #66255-5  
TYPE XII CONT ASY MALE

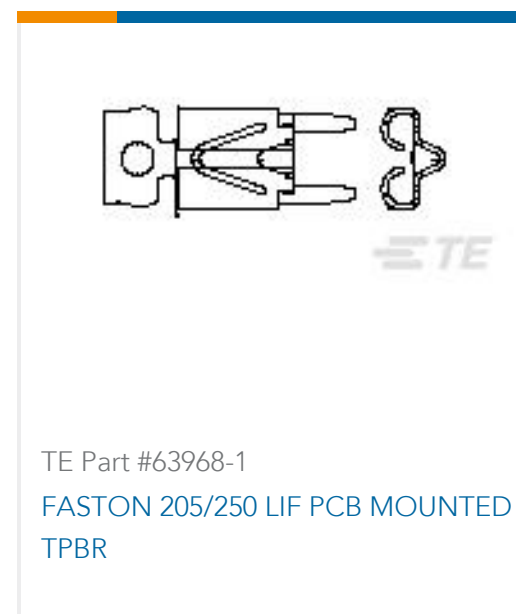

TE Part #63968-1  
FASTON 205/250 LIF PCB MOUNTED TPBR



TE Part #2027395-1  
T9SV1K15-12



TE Part #350687-1  
UMNL SPLIT PIN PTPBR



TE Part #1825232-1  
SLIDE SWITCH,SPDT,Right Angle



TE Part #1-640415-0  
UMNL KEYING PLUG V0

## Documents

### Product Drawings

#### 06P UMNL PLUG, GWI-V2

English

### CAD Files

#### 3D PDF

3D

#### Customer View Model

[ENG\\_CVM\\_CVM\\_794816-2\\_A\\_c-794816-2-a.2d\\_dxf.zip](#)

English

#### Customer View Model

[ENG\\_CVM\\_CVM\\_794816-2\\_A\\_c-794816-2-a.3d\\_igs.zip](#)

English

#### Customer View Model

[ENG\\_CVM\\_CVM\\_794816-2\\_A\\_c-794816-2-a.3d\\_stp.zip](#)

English

By downloading the CAD file I accept and agree to the [Terms and Conditions](#) of use.

### Product Specifications

#### Application Specification

English

### Product Environmental Compliance

#### TE Material Declaration

English

### Agency Approvals

#### VDE Certificate

794816-2

Rectangular Power Connectors, Housing, Plug, Wire-to-Wire / Wire-to-Board, 6  
Position, 6.35 mm [.25 in] Centerline, Wire & Cable, Universal MATE-N-LOK



English